

# Bode 100

## User Manual



Version: ENU1006 05 09 — Year: 2023

© OMICRON Lab, OMICRON electronics. All rights reserved.

This manual is a publication of OMICRON electronics.

All rights including translation reserved. Reproduction of any kind, e.g., photocopying, microfilming, optical character recognition and/or storage in electronic data processing systems, requires the explicit consent of OMICRON electronics. Reprinting, wholly or in part, is not permitted.

The product information, specifications, and technical data embodied in this manual represent the technical status at the time of writing and are subject to change without prior notice.

Windows is a registered trademark of Microsoft Corporation. OMICRON Lab and Smart Measurement Solutions are registered trademarks of OMICRON electronics.

# Contents

<b>1</b>	<b>About this User Manual</b>	<b>6</b>
<b>2</b>	<b>Safety instructions</b>	<b>7</b>
2.1	Operator qualifications	7
2.2	Rules for use	7
2.3	Designated use	8
2.4	Cleaning	8
<b>3</b>	<b>Compliance statements and recycling</b>	<b>9</b>
3.1	Compliance statement	9
3.2	Information for disposal and recycling	9
<b>4</b>	<b>Bode 100 and accessories</b>	<b>10</b>
4.1	Delivered items	10
4.2	Optional accessories	11
<b>5</b>	<b>Technical data</b>	<b>12</b>
5.1	Absolute maximum ratings	12
5.2	Bode 100 specifications	13
5.3	System requirements	14
5.4	Environmental requirements	14
5.5	Mechanical data	14
<b>6</b>	<b>Device overview</b>	<b>15</b>
6.1	Connectors	15
6.2	Block diagram	17
6.3	Functional description	18
6.4	Hardware revisions	18
<b>7</b>	<b>Bode Analyzer Suite introduction</b>	<b>19</b>
7.1	Start screen	19
7.2	Main window	20
7.2.1	Measurement configuration	22
7.2.2	Trace configuration	24
7.2.3	Ribbon controls	26
7.2.4	Status bar	29
7.3	Chart context menu	30
7.4	Options menu	31
<b>8</b>	<b>Measurement types and applications</b>	<b>36</b>
8.1	Gain measurement introduction	37
8.2	Impedance measurement introduction	39
8.3	Vector Network Analysis	44
8.3.1	Transmission / Reflection	44
8.3.2	Gain / Phase	50

8.3.3	Reflection with external coupler .....	51
8.4	Impedance analysis .....	52
8.4.1	One-Port .....	52
8.4.2	Impedance Adapter .....	61
8.4.3	Shunt-Thru .....	66
8.4.4	Shunt-Thru with series resistance .....	68
8.4.5	Series-Thru .....	69
8.4.6	Voltage/Current .....	70
8.4.7	External Bridge .....	71
8.5	Advanced .....	72
8.5.1	SCPI server .....	72
<b>9</b>	<b>Measurement and Device settings .....</b>	<b>74</b>
9.1	Hardware setup .....	74
9.2	Receiver Bandwidth .....	76
9.3	Choosing the receiver attenuator .....	78
9.4	Signal source settings .....	80
9.5	Using external probes .....	83
<b>10</b>	<b>Calibration / Correction .....</b>	<b>85</b>
10.1	Internal device calibration .....	85
10.2	Performing a Gain Calibration .....	86
10.2.1	Calibrating a Transmission (S21) measurement .....	88
10.2.2	Calibrating a Gain/Phase measurement .....	89
10.3	Performing an Impedance Calibration .....	91
10.3.1	Calibrating a Reflection or One-Port Impedance measurement .....	94
10.3.2	Calibrating an External Coupler or External Bridge measurement .....	96
10.3.3	Calibrating an Impedance Adapter measurement .....	98
10.3.4	Calibrating a Shunt-Thru or Series-Thru measurement .....	100
10.3.5	Calibrating a Voltage/Current measurement .....	102
10.4	Further calibration information .....	103
10.4.1	Difference between Full-Range and User-Range calibration .....	103
10.4.2	Enabling and disabling a calibration .....	105
10.4.3	Re-performing a calibration .....	106
10.4.4	Full-Range calibration below 10 Hz .....	106
10.4.5	Automatic deletion of calibration .....	107
10.4.6	Saving calibration data .....	107
10.4.7	Exporting calibration data .....	108
<b>11</b>	<b>Bode Analyzer Suite software features .....</b>	<b>109</b>
11.1	Exporting and saving measurement data or settings .....	109
11.1.1	Loading and saving the equipment configuration .....	109
11.1.2	Use the clipboard functions to export data .....	109
11.1.3	Use the clipboard to import data .....	111
11.1.4	Exporting measurement data to CSV or Excel files .....	113



11.1.5	Generating a Touchstone file .....	115
11.1.6	Generate a PDF report .....	116
11.2	Using the interactive chart .....	117
11.2.1	Configure the diagrams .....	117
11.2.2	Zooming the measurement curve .....	119
11.2.3	Optimize the axis scaling / autoscale .....	122
11.3	Working with cursors and the cursor table .....	125
11.3.1	The cursor table .....	125
11.3.2	Using cursors in the chart .....	126
11.3.3	Link cursors .....	128
11.4	Using the memory traces .....	130
11.5	Working with measurement and math traces .....	134
11.5.1	Measurement traces .....	135
11.5.2	Math traces .....	136
11.5.3	Expression traces .....	137
11.6	Port extension .....	141
11.7	Cursor calculations .....	143
11.7.1	Non-Invasive Stability Measurement .....	143
11.7.2	Fres-Q Calculation .....	145
11.7.3	Stability margin calculation .....	147
11.8	Averaging .....	150
11.9	Unwrapped phase .....	151
11.10	Check for updates .....	153
<b>12</b>	<b>Automating measurements .....</b>	<b>154</b>
<b>13</b>	<b>Troubleshooting .....</b>	<b>155</b>
	<b>Support .....</b>	<b>156</b>
	<b>Index .....</b>	<b>157</b>

# 1 About this User Manual

This manual was written for professional specialists in electronics and electrical engineering. Its purpose is to familiarize you with the *Bode 100* vector network analyzer and its various application fields. It contains helpful instructions on how to use *Bode 100* safely, properly, and efficiently.

This *Bode 100* manual provides you information on how to install the *Bode Analyzer Suite* and how to use it in combination with the *Bode 100* vector network analyzer.

## Safety symbols used in this document



### DANGER

Death or severe injury will occur if the appropriate safety instructions are not observed.



### WARNING

Death or severe injury can occur if the appropriate safety instructions are not observed.



### CAUTION

Minor or moderate injury may occur if the appropriate safety instructions are not observed.

### NOTICE

Equipment damage or loss of data possible

## 2 Safety instructions

Before operating *Bode 100* and its accessories, read the following safety instructions carefully. If you do not fully understand any safety instruction or any part thereof, contact OMICRON Lab before proceeding. When working with *Bode 100*, observe all safety instructions in this document. You are responsible for every application that makes use of an OMICRON or OMICRON Lab product. Any miss-operation can result in damage to property or persons. Maintenance and repair of *Bode 100* and its accessories is only permitted by qualified experts either at OMICRON Lab or at certified repair centers.

Following these instructions will help you to prevent danger, repair costs and possible down time due to incorrect operation. Furthermore, it ensures the reliability and life-cycle of *Bode 100*.



Use *Bode 100* in observance of all existing safety requirements from national standards for accident prevention and environmental protection.

Reading the *Bode 100* manual alone does not release you from the duty of complying with all national and international safety regulations relevant for working with *Bode 100*.

### 2.1 Operator qualifications

- Testing with *Bode 100* must only be carried out by qualified, skilled and authorized personnel.
- Personnel receiving training, instructions, directions, or education on *Bode 100* must be under constant supervision of an experienced operator while working with the equipment.
- Testing with *Bode 100* must comply with the on-site safety instructions as well as additional relevant documents.

### 2.2 Rules for use

- *Bode 100* is exclusively intended for the application area specified in this document. The manufacturer/distributors are not liable for damage resulting from a use other than the specified operation. The user alone assumes all responsibility and risk.
- Use *Bode 100* only when it is in a technically sound condition.
- Do not open *Bode 100* or remove any of its housing components.
- The *Bode 100* does not contain any serviceable parts. Do not open the *Bode 100* or carry out any modifications, extensions, or adaptations.
- Use *Bode 100* in observance of all existing safety requirements from national and international standards for accident prevention and environmental protection.
- Always keep the manual either printed or as PDF file at the site where *Bode 100* is used. The manual must be read by all people working with *Bode 100*. In addition to the manual and the applicable regulations for accident prevention in the country and at the site of operation, heed the accepted technical procedures for safe and competent work.

## 2.3 Designated use

*Bode 100* and its accessories are especially designed for swept frequency measurements of electronic circuits in laboratory and manufacturing environments.

Typical applications are:

- Measurement of the complex transfer function of amplifiers, filters and attenuators
- S-Parameter measurement in the 50  $\Omega$  domain
- Stability assessment of control loops
- Determination of resonance frequencies of piezo elements and quartz crystals
- Impedance measurement of inductors, capacitors and resistors

### Disclaimer

The advisory procedures and information contained within this document have been compiled as a guide to the safe and effective operation of *Bode 100*. It has been prepared in conjunction with application engineers and the collective experience of the manufacturer. The in-service conditions for the use of *Bode 100* may vary between customers and end-users.

Consequently, this document is offered as a guide only. It shall be used in conjunction with the customers own safety procedures, maintenance program, engineering judgment, and training qualifications.

Using *Bode 100* or its accessories in a manner not specified by the manufacturer may result in damage to property or persons.

## 2.4 Cleaning

Use a cloth dampened with isopropanol alcohol to clean *Bode 100* and its accessories.

## 3 Compliance statements and recycling

### 3.1 Compliance statement

#### Declaration of conformity (EU)

The equipment adheres to the guidelines of the council of the European Community for meeting the requirements of the member states regarding the electromagnetic compatibility (EMC) directive and the RoHS directive.

#### Declaration of conformity (UK)

The equipment adheres to the regulations of the UK government for meeting the requirements regarding the Electromagnetic Compatibility (EMC) Regulation and the Regulation for Restriction of the Use of Certain Hazardous Substances in Electrical and Electronic Equipment.

#### FCC compliance (USA)

This equipment has been tested and found to comply with the limits for a Class A digital device, pursuant to part 15 of the FCC Rules. These limits are designed to provide reasonable protection against harmful interference when the equipment is operated in a commercial environment. This equipment generates, uses, and can radiate radio frequency energy and, if not installed and used in accordance with the instruction manual, may cause harmful interference to radio communications. Operation of this equipment in a residential area is likely to cause harmful interference, in which case the user will be required to correct the interference at his own expense. Changes or modifications not expressly approved by the party responsible for compliance could void the user's authority to operate the equipment.

#### Declaration of compliance (Canada)

This Class A digital apparatus complies with Canadian ICES-003. Cet appareil numérique de la classe A est conforme à la norme NMB-003 du Canada.



The use of the delivered mains adapter is required to comply with FCC and ICES rules as well as the EMC directive.

### 3.2 Information for disposal and recycling

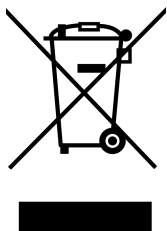

*Bode 100* and all of its accessories are not intended for household use. At the end of its service life, do not dispose of the test set with household waste!

#### For customers in EU countries (incl. European Economic Area)

OMICRON test sets are subject to the EU Waste Electrical and Electronic Equipment Directive (WEEE directive). As part of our legal obligations under this legislation, OMICRON offers to take back the test set and to ensure that it is disposed of by an authorized recycling facility.

#### For customers outside the European Economic Area

Please contact the authorities in charge for the relevant environmental regulations in your country and dispose *Bode 100* and all of its accessories only in accordance with your local legal requirements.

## 4 Bode 100 and accessories





### 4.1 Delivered items

 <p><i>Bode 100</i> multi functional test set</p>	 <p><i>Bode Analyzer Suite</i> on DVD</p>	 <p>Wide-range AC power supply including mains input plugs for different national standards</p>
 <p>Test objects (Quartz filter and IF filter) on PCB</p>	 <p>USB Cable</p>	 <p>4 pc. BNC 50 <math>\Omega</math> cables with 500 mm length (m-m)</p>
 <p>BNC adapters (straight, T, Short, Load 50 <math>\Omega</math>)</p>	 <p><i>Bode 100</i> Quick Start Guide + Multilingual Safety Instructions</p> <p><i>Bode 100</i> Quick Start Guide</p>	

 The delivered items may vary a bit from the look shown above. Please refer to the packing list received with the *Bode 100* for further information

 We strongly recommend to use the original wide-range AC power supply delivered with *Bode 100*.

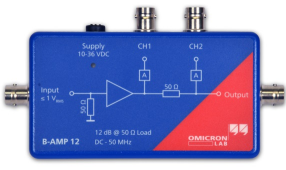
## 4.2 Optional accessories

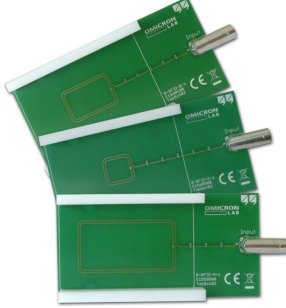
	<p><b>B-WIT 100 Wideband Injection Transformer &amp; B-LFT 100 Low-Frequency Injection Transformer</b></p> <p>The B-WIT 100 and B-LFT 100 are used to inject signals into control loops. Its main application are the stability analysis of switched mode power supplies and linear voltage regulators.</p> <p>B-WIT 100 order number: OL000151 B-LFT 100 order number: OL000169</p>
	<p><b>PML-111O 10:1 Passive Probe</b></p> <p>PML-111O is a passive 10:1 probe designed for the input stage of Bode 100. It is manufactured by PMK in Germany and fits perfectly to the Bode 100.</p> <p>Order number: OL000110</p>
	<p><b>B-WIC &amp; B-SMC Impedance test fixtures</b></p> <p>B-WIC and B-SMC extend the impedance measurement range of <i>Bode 100</i>. They enable you to easily measure THT or SMD components such as inductors and capacitors.</p> <p>B-WIC order number: OL000152 B-SMC order number: OL000153</p>
	<p><b>B-AMP 12 Amplifier</b></p> <p>12 dB amplifier to boost the output signal of <i>Bode 100</i> for applications where more than 13 dBm are needed.</p> <p>Order number: OL000168</p>
	<p><b>B-LCM Common Mode Choke</b></p> <p>A low-frequency common mode choke to reduce ground-loop errors in e.g. Shunt-Thru measurements.</p> <p>Order number: OL000175</p>
	<p><b>B-RFID Measurement Adapters</b></p> <p>The B-RFID adapters allow standard compliant measurement of the resonance frequency and Q-factor of RFID antennas.</p> <p>Order numbers: OL000170-OL000173</p>



For more information on the above mentioned *Bode 100* accessories and recommended accessories manufactured by partner companies visit [www.omicron-lab.com](http://www.omicron-lab.com).

## 5 Technical data

In this section you can find the most important technical data valid for the *Bode 100 Revision 2* device. You can download a detailed technical data sheet for *Bode 100 Revision 1* as well as *Bode 100 Revision 2* from the OMICRON Lab website [www.omicron-lab.com](http://www.omicron-lab.com) → Bode 100 → Technical Data.

### NOTICE

#### Risk of permanent damage of the device.

Exceeding the absolute maximum ratings might result in equipment damage.

- ▶ Do not exceed the absolute maximum ratings listed below.

### 5.1 Absolute maximum ratings

Table 5-1: Absolute maximum ratings

Characteristic	Absolute Maximum Rating
<b>DC Power Input</b>	
Max. DC supply voltage	+28 V
Max. DC supply reverse voltage	-28 V
<b>INPUT CH 1, INPUT CH 2 connectors (1 M<math>\Omega</math> input impedance selected)</b>	
Maximum DC input signal	50 V
Maximum AC input signal	1 Hz...1 MHz: 50 Vrms 1 MHz...2 MHz: 30 Vrms 2 MHz...5 MHz: 15 Vrms 5 MHz...10 MHz: 10 Vrms 10 MHz ... 50 MHz: 7 Vrms
<b>INPUT CH 1, INPUT CH 2 connectors (50 <math>\Omega</math> input impedance selected)</b>	
Maximum input power	1 W
Maximum input voltage	7 Vrms
<b>OUTPUT connector</b>	
Maximum reverse power	0.5 W
Maximum reverse voltage	5 Vrms ( $\leq$ 3.3 Vdc recommended)



## 5.2 Bode 100 specifications

Table 5-2: Bode 100 Revision 2 specifications:

Characteristic	Rating
Frequency range	1 Hz to 50 MHz
<b>OUTPUT</b>	
Waveform	Sinusoidal
Signal level range	-30 dBm...13 dBm 7 mVrms...1 Vrms (50 Ω load) 14 mVrms...2 Vrms (no load)
Source level accuracy	±0.3 dB (1 Hz to 1 MHz) ±0.6 dB (1 MHz to 50 MHz)
Source level frequency response (flatness)	±0.3 dB (typical, referring to 10 MHz)
Frequency accuracy after adjustment	± 2 ppm ± 0.5 stepsize
Frequency resolution (step size)	0.00605 Hz (1 Hz to 100 Hz) 0.03632 Hz (100 Hz to 50 MHz)
Source impedance	50 Ω
Return loss (1 Hz to 50 MHz)	>30 dB, >35 dB (typical)
Spurious signals & harmonics	<-55 dBc (typical)
Maximum reverse signal / power	0.5 W = 5 Vrms (≤ 3.3 Vdc recommended)
<b>INPUT CH 1, INPUT CH 2</b>	
Input impedance (software switchable)	<b>High:</b> 1 MΩ (AC-coupled) <b>Low:</b> 50 Ω (DC-coupled)
1 MΩ input impedance	1 MΩ ±2%    40...55 pF
50 Ω input impedance return loss	> 28 dB, >35 dB typical (1 Hz to 50 MHz)
Receiver bandwidth (RBW) software selectable	1 Hz, 3 Hz, 10 Hz, 30 Hz, 100 Hz, 300 Hz, 1 kHz, 3 kHz , 5 kHz
Input attenuators (software selectable)	0 dB, 10 dB, 20 dB, 30 dB, 40 dB
Full-scale AC input signal	100 mVrms @ 0 dB input attenuator 316 mVrms @ 10 dB input attenuator 1 Vrms @ 20 dB input attenuator 3.16 Vrms @ 30 dB input attenuator 10 Vrms @ 40 dB input attenuator
Input channel sensitivity (typical)	1 μVrms (0 dB attenuator, 10 Hz RBW)
Maximum DC voltage (1 MΩ input impedance)	1 MΩ input impedance: 50 V 50 Ω input impedance: 7 V
Input channels dynamic Range	> 100 dB (10 Hz RBW)
Noise floor (S21 measurement) RBW = 10 Hz, PSOURCE = 13 dBm, Attenuator CH1: 20 dB, CH2: 0 dB	1 Hz to 10 kHz: -115 dB (typical) 10 kHz to 10 MHz: -125 dB (typical) 10 MHz to 50 MHz: -105 dB (typical)
Gain Error	< 0.1 dB (User-Range calibrated)
Phase Error	< 0.5° (User-Range calibrated)
OUTPUT, CH1, CH2 connector type	BNC

Characteristic	Rating
USB interface connector	USB type B socket
<b>Bode 100 power requirements</b>	
Supply voltage range	+9 VDC to +24 VDC
Power demand	< 10 W
Connector type	Coaxial power socket (2.5 mm / 5.5mm) Inner conductor is positive

## 5.3 System requirements

Table 5-3: System requirements

Characteristic	Minimum PC Configuration
Processor	Intel Core-i Dual-Core (or similar)
Memory (RAM)	2 GB, 4 GB recommended
Graphics resolution	Super VGA (1024x768) higher resolution recommended
Graphics card	DirectX 11 with Direct2D support
USB interface	USB 2.0 or higher
Operating System	Microsoft Windows 10
Software	Bode 100 Revision 2 requires Bode Analyzer Suite 3.00 or newer.

## 5.4 Environmental requirements

Table 5-4: Environmental requirements

Characteristic	Condition	Rating
Temperature	Storage	-35 ... +60 °C / -31...+140 °F
	Operating	+5 ... +40 °C / -41...+104 °F
	For specification	23 °C ±5 °C / 73 °F ±18 °F
Relative humidity	Storage	20 ... 90 %, non-condensing
	Operating	20 ... 80 %, non-condensing

## 5.5 Mechanical data

Table 5-5: Mechanical data

Characteristic	Rating
Dimensions (w x h x d) without connectors	26 cm x 5 cm x 26.5 cm / 10.25 " x 2 " x 10.5 "
Weight	< 2 kg / 4.4 lbs

## 6 Device overview

*Bode 100* is a USB controlled vector network analyzer. The system consists of the *Bode 100* hardware and the *Bode Analyzer Suite* software. In the following the *Bode 100* hardware is described in detail. To learn more about the *Bode Analyzer Suite*, please check out [7.1 Start screen](#) on page 19 ff.

### 6.1 Connectors

*Bode 100* provides the following three connectors at the front panel:

- OUTPUT: signal output (BNC socket)
- CH 1: channel 1 signal input (BNC socket)
- CH 2: channel 2 signal input (BNC socket)

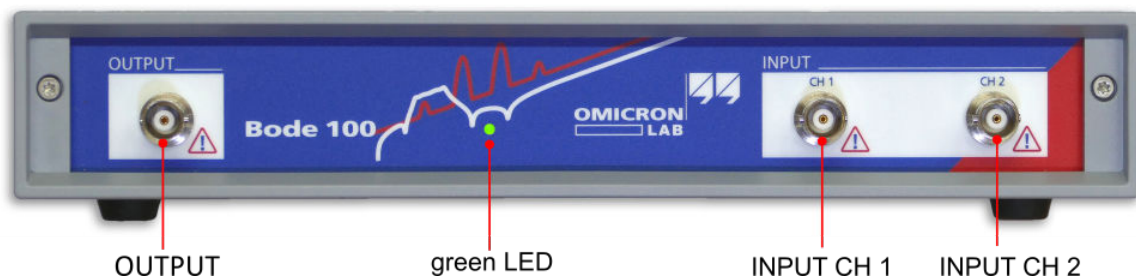

Figure 6-1: *Bode 100* front view



#### WARNING

**Death or severe injury can occur if hazardous voltages are connected to the *Bode 100*.**

***Bode 100*** is a SELV device (SELV = Safety Extra Low Voltage according to IEC 60950-1).

- ▶ Do not apply voltage levels  $>50$  VDC or  $>25$  VAC to the inputs of *Bode 100*.
- ▶ Be aware that no indication on *Bode 100* shows that the output is active. This could be especially critical if amplifiers are connected to *Bode 100*.

*Bode 100* provides the following three connectors at the rear panel:

- Supply power input for DC voltages from 9 V to 24 V (5.5 mm coaxial plug with 2.5 mm pin)
- USB: data interface (USB type B port)
- $\perp$  : Ground connector for external ground connection (4 mm banana-socket)

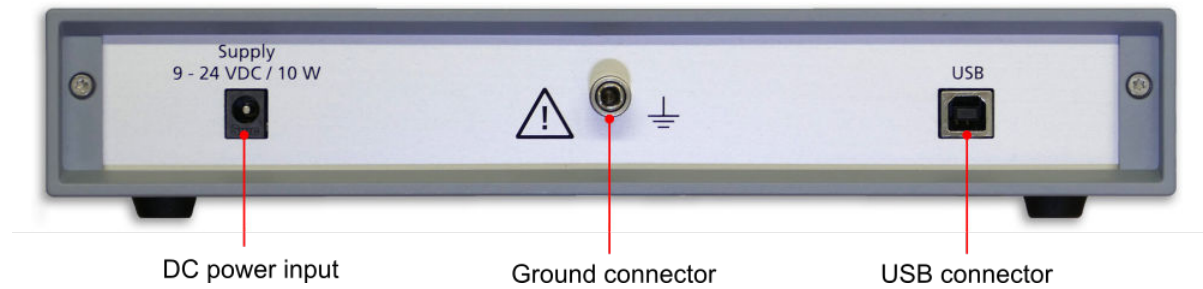

Figure 6-2: *Bode 100* rear view

#### NOTICE

##### **Risk of permanent damage of the device.**

Exceeding the absolute maximum ratings might result in equipment damage.

- ▶ The AC-coupled inputs represent a high impedance for DC signal. Before using passive probes, check out [9.5 Using external probes](#) on page 83.

## 6.2 Block diagram

*Bode 100* is a flexible device that features the following major building blocks:

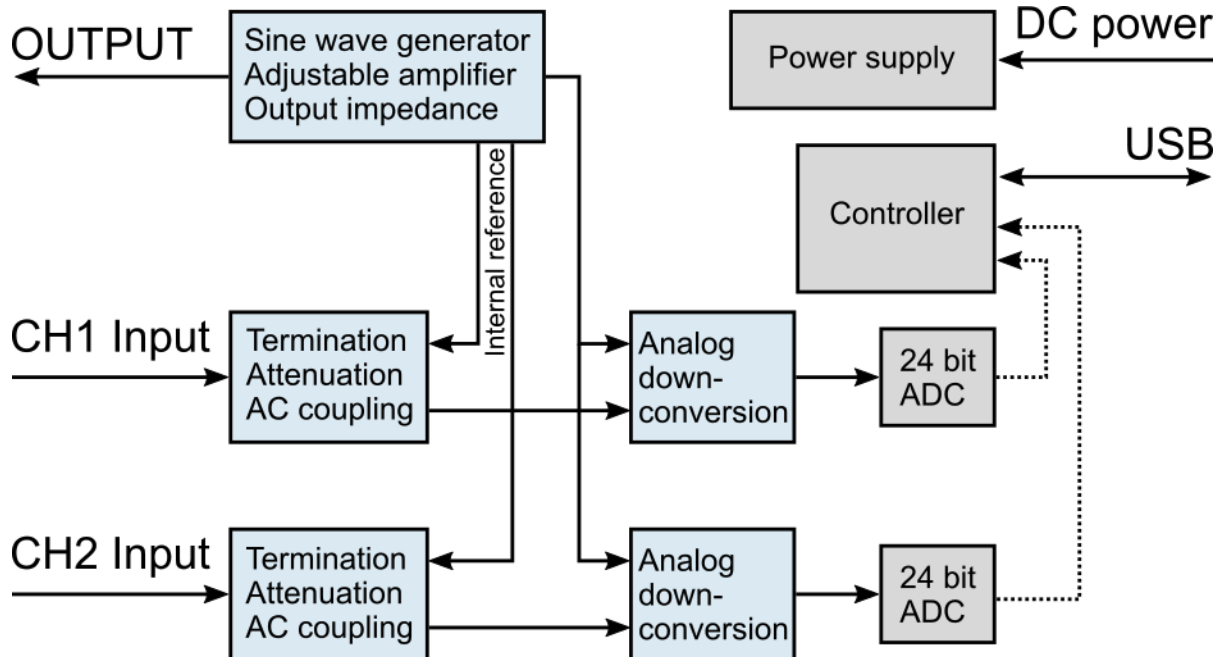

Figure 6-3: *Bode 100* block diagram

- Signal source:**  
 The signal source of *Bode 100* consists of an adjustable DDS sine-wave generator and adjustable amplifiers. The output impedance of *Bode 100* is 50  $\Omega$ . More information can be found in [Signal Source Settings](#) on page 80  
 Internal reference connections allow to directly connect the source signal to the receivers.
- Channel inputs:**  
 Each of the *Bode 100* input features adjustable attenuators (see [Choosing the receiver attenuator](#) on page 78) for best signal / noise ratio and software-switchable termination. Channel termination can be either 50  $\Omega$  or 1 M $\Omega$ . Without 50  $\Omega$  terminations the inputs are AC coupled, representing a very high impedance at DC.
- Down conversion & sampling:**  
 The input signal is down-converted to an intermediate frequency and sampled by a 24bit ADC. The sampled data is sent to the PC and evaluated by the *Bode Analyzer Suite*.

More details on the hardware configuration can also be found in [9.1 Hardware setup](#) on page 74.

## 6.3 Functional description

The flexible hardware concept of *Bode 100* allows to use it for several applications such as:

- Transmission / Reflection measurements
- Gain / Phase (transfer function) measurements
- Impedance measurements

The device operates in a wide frequency range from 1 Hz to 50 MHz. *Bode 100* creates a sine-wave at a frequency and measures two voltages. The creation of the sine wave and both voltage measurements are synchronized such that magnitude and phase relation of the two measured voltages can be derived.

From the magnitude and phase ratio of the two voltages, the *Bode Analyzer Suite* calculates Impedance, Reflection, Admittance, Transmission or complex Gain values of the DUT (Device Under Test).

For a complete list of all possible measurements that you can perform with *Bode 100* see [8 Measurement types and applications](#) on page 36.

## 6.4 Hardware revisions

Currently there are two mayor hardware revisions of *Bode 100* available. Revision 1 and Revision 2. To find out if you are using a *Bode 100 R1* or a *Bode 100 R2*, check the identification plate on the bottom of the device.

Below typical identification plates for a *Bode 100 R1* and a *Bode 100 R2* are shown.

*Bode 100 R1*



*Bode 100 R2*

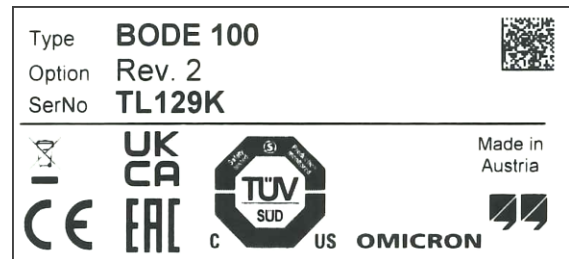

If **Option** is **Rev. 2**, you are using a *Bode 100 R2*. If **Option** is empty, you are using a *Bode 100 R1*.

Your identification plate might look slightly different due to different declaration logos or other reasons.

## 7 Bode Analyzer Suite introduction

In this section you will learn the basics of the *Bode Analyzer Suite 3.25*. The window structure and the main functionality is explained.

### Step-by-step examples

 Get a quick introduction to the *Bode Analyzer Suite* and how to use *Bode 100* by following the **step-by-step examples**. The following examples are available in this manual:

- Perform a Transmission / Reflection measurement on the IF filter DUT, see [Transmission / Reflection measurement example](#) on page 45.
- Perform a one-port impedance measurement on the Quartz filter DUT, see [One-Port measurement example](#) on page 53.
- Measure impedance of an inductor using the impedance adapter, see [Impedance Adapter example](#) on page 62.

### 7.1 Start screen

When starting the *Bode Analyzer Suite*, the Start screen is shown.

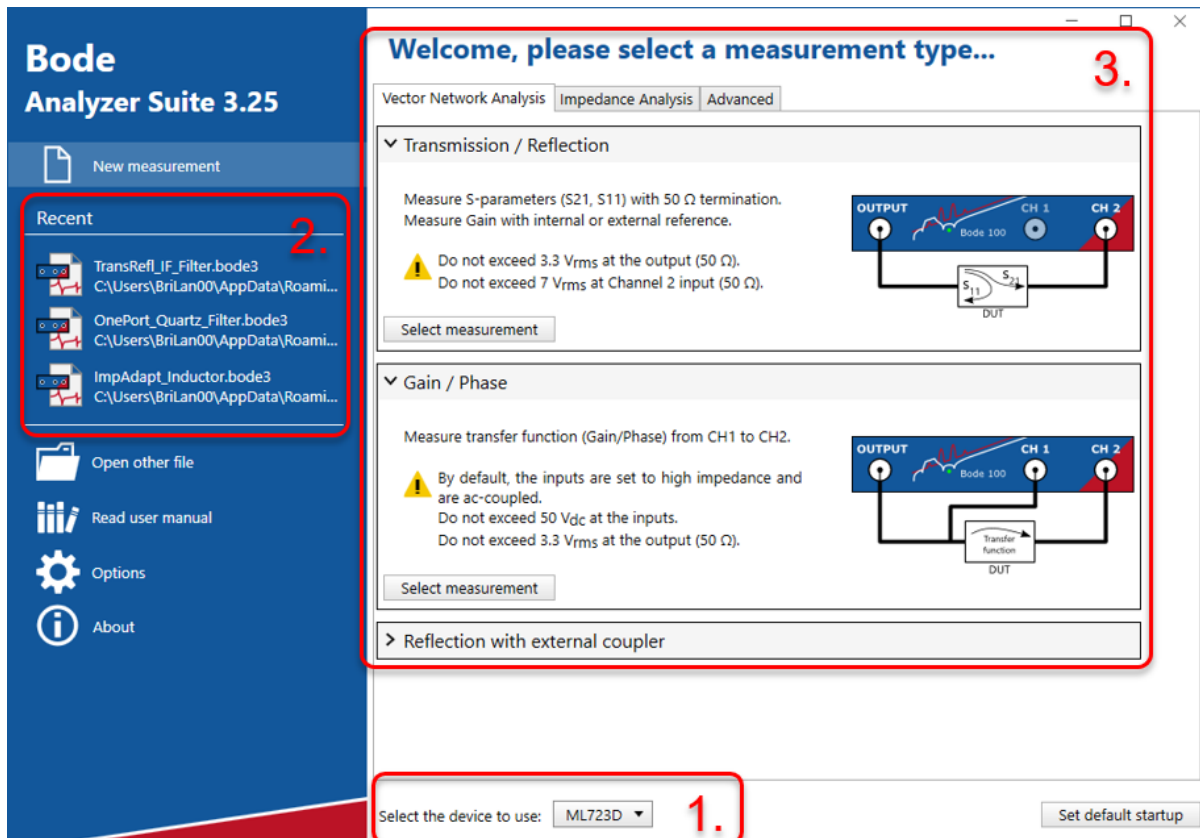

Figure 7-1: *Bode Analyzer Suite* Start screen.

The Start screen allows the following user interactions:

- Choose the device to use (1.). This field is only visible if you have a *Bode 100* device connected to your PC.
- Open a recent file or other file (2.). On your first start-up the demo-files are listed here. Check out the [examples](#) that explain the content of the demo-files.
- Select one of the available measurement modes (3.) and start a measurement.

**i** **Hint:** If you prefer to automatically start a measurement instead of entering the Start screen, choose your default startup measurement mode by clicking on **Set default startup** and choosing your preferred startup mode. You can also choose a .bode3 file to be your default startup configuration.

## 7.2 Main window

After starting a measurement the Main window of the *Bode Analyzer Suite* is opened.

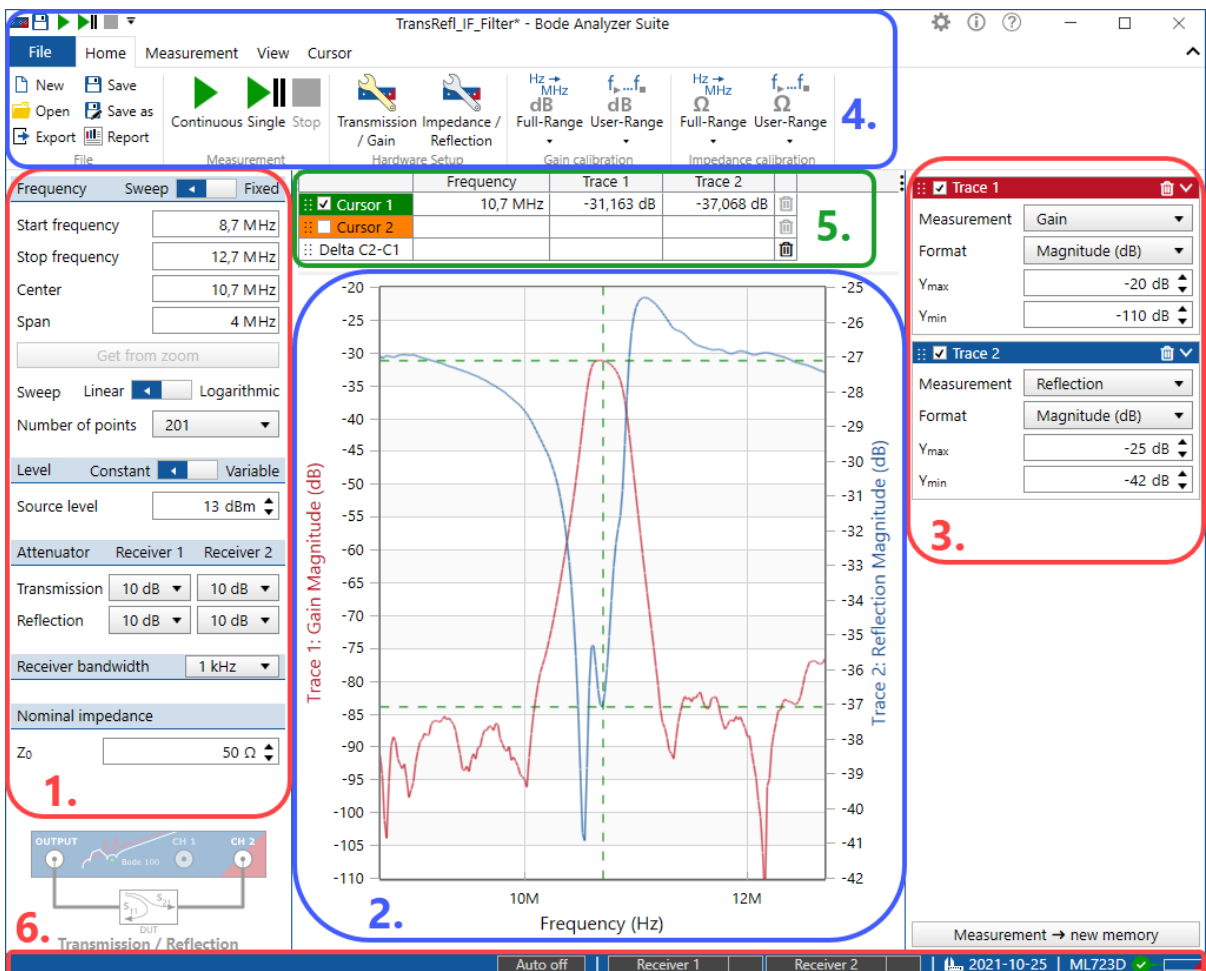

Figure 7-2: *Bode Analyzer Suite* Main window.



The Main window is structured into six main regions:

1. **Measurement configuration**  
The measurement configuration allows to configure the measurement frequencies and some hardware setup elements such as the source level, the attenuators and the receiver bandwidth.
2. **Chart region**  
In the chart region the measurement results are displayed. You can use the Trace settings on the right hand side to choose the result that shall be displayed. Different formats such as Magnitude or Phase as well as different diagrams such as Polar, Nyquist or Smith can be selected. To learn more about the result diagrams, have a look at [11.2 Using the interactive chart](#) on page 117.
3. **Trace settings**  
Choose what measurement and which result format is displayed in a trace. Additional memory traces or math traces are also controlled in this region. Learn more about how to configure traces and memories in [11.4 Using the memory traces](#) on page 130 and [11.5 Working with measurement and math traces](#) on page 134.
4. **Ribbon bar & Quick-Access**  
The ribbon bar contains the file operation commands as well as the buttons to start and stop a measurement. Further possibilities are the hardware setup, calibration, view settings, memory operations and cursor commands.
5. **Cursor table**  
The cursor table displays the values of the movable cursors that are attached to the traces shown in the result diagrams. To learn more about how to use the cursors, check out [11.3 Working with cursors and the cursor table](#) on page 125.
6. **Status bar**  
The status bar shows the connection state of the hardware and the receiver levels. Further possibilities are signal source control and internal device calibration control.

## 7.2.1 Measurement configuration

Frequency	Sweep	Fixed
Start frequency	<input type="text" value="100 kHz"/>	
Stop frequency	<input type="text" value="40 MHz"/>	
Center	<input type="text" value="20,05 MHz"/>	
Span	<input type="text" value="39,9 MHz"/>	
<input type="button" value="Get from zoom"/>		
Sweep	Linear	Logarithmic
Number of points	<input type="text" value="201"/>	

Level	Constant	Variable
Source level	<input type="text" value="0 dBm"/>	

Attenuator	Receiver 1	Receiver 2
Transmission	<input type="text" value="20 dB"/>	<input type="text" value="20 dB"/>
Reflection	<input type="text" value="10 dB"/>	<input type="text" value="10 dB"/>

Receiver bandwidth	<input type="text" value="1 kHz"/>
--------------------	------------------------------------

### Frequency

In **Frequency sweep** mode you can change either Start frequency and Stop frequency or Center and Span.

**Get from zoom** updates Start frequency and Stop frequency with the current zoom window range.

Furthermore, the sweep mode can be Linear or Logarithmic and the number of points in the sweep can be chosen.

In **Fixed Frequency** mode only the Source frequency can be adjusted. In this case the *Bode 100* will display a vector chart instead of a frequency dependent chart.

### Source level

Choose between a constant or variable output level (shaped level) and set the source level. The variable output level feature is only available in the Frequency sweep measurement. It allows to define different source levels for different frequency points. To learn more about the source control, refer to [9.4 Signal source settings](#) on page 80.

### Attenuators

Set the input attenuators for Receiver 1 (Channel 1) and Receiver 2 (Channel 2). If the measurement mode supports two measurements (Transmission and Reflection) you can set the attenuators for each measurement. Possible attenuator values are 0 dB, 10 dB, 20 dB, 30 dB and 40 dB. Increase the attenuators when you experience an overload, reduce the attenuators to improve signal to noise ratio (see also [Choosing the receiver attenuator](#) on page 78).

### Receiver bandwidth

Set the maximum Receiver bandwidth used for the measurement. Receiver bandwidth will be reduced internally if the measurement frequency is smaller than the Receiver bandwidth setting.

Select a high Receiver bandwidth to increase measurement speed. Reduce Receiver bandwidth to reduce noise and to catch narrow-band resonances. More details can be found in [Receiver Bandwidth](#) on page 76.

### Nominal impedance

$Z_0$

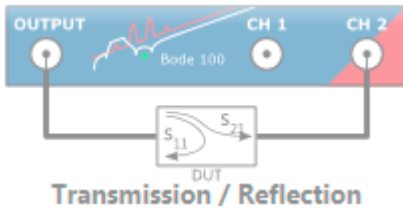

### Nominal impedance

The nominal impedance or characteristic impedance value is used to calculate the Reflection factor. See also [8.2 Impedance measurement introduction](#) on page 39. Note that this field is only visible if a reflection measurement is performed.

### Measurement mode

Shows what measurement mode is currently used. All available measurement modes are explained in [8 Measurement types and applications](#) on page 36.

## 7.2.2 Trace configuration

In a Frequency Sweep measurement, the right hand side of the *Bode Analyzer Suite* shows the Trace configuration. The Trace configuration allows to choose what measurement (Gain, Impedance, Reflection, Admittance) is performed and how it is displayed in the chart.

### Trace configuration box:

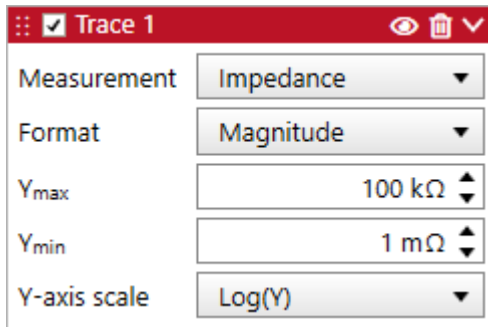

The Trace configuration box displays the trace-name and allows to configure:

Use the checkbox to the left of the trace name to disable the trace (including the corresponding axis / chart).

Click  to hide the measurement curve of Trace 1 without deactivating the corresponding axis and Memory traces.

Click  to delete Trace 1.

Click  and hold to drag the trace to re-order traces & charts or to move the data from one file to another.

**Measurement: Impedance**, defines that Trace 1 measures & displays impedance.

**Format: Magnitude**, defines that Trace 1 displays the Magnitude of Impedance.

**Ymax: 100 Ω**, The upper limit of the y-axis displayed in the diagram.

**Ymin: 1 mΩ**, The lower limit of the y-axis displayed in the diagram.

**Y-axis scale : Log(Y)**, Currently the y-axis is set to a logarithmic scaling.

Learn more about the trace configuration box in [11.5 Working with measurement and math traces](#) on page 134.

The memory configuration box allows to control the memory curves:

Use the checkbox to the left of the memory name to disable (hide) the memory trace.

Click  to copy the current measurement data to Memory 1.

Click  to delete the Memory 1 trace.

Click  to link the cursors to Memory 1.

Click  and hold to drag the memory trace for re-ordering of the traces or to move the data from one file to another.

Furthermore it can be selected via the "Show with" checkbox in which diagram the memory data is shown.

Learn more about the memory curves in [11.4 Using the memory traces](#) on page 130.

### Memory configuration box:

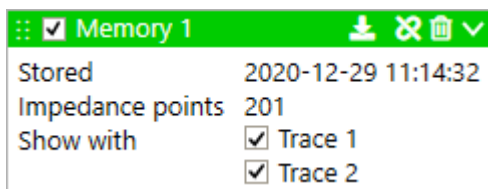

**Hint:** By clicking the inner border of the Measurement configuration or Trace configuration you can collapse these configuration areas to create a bigger chart area. You can fold out the configurations anytime by clicking the respective areas at the side of the chart area. For more details refer to the figure below.

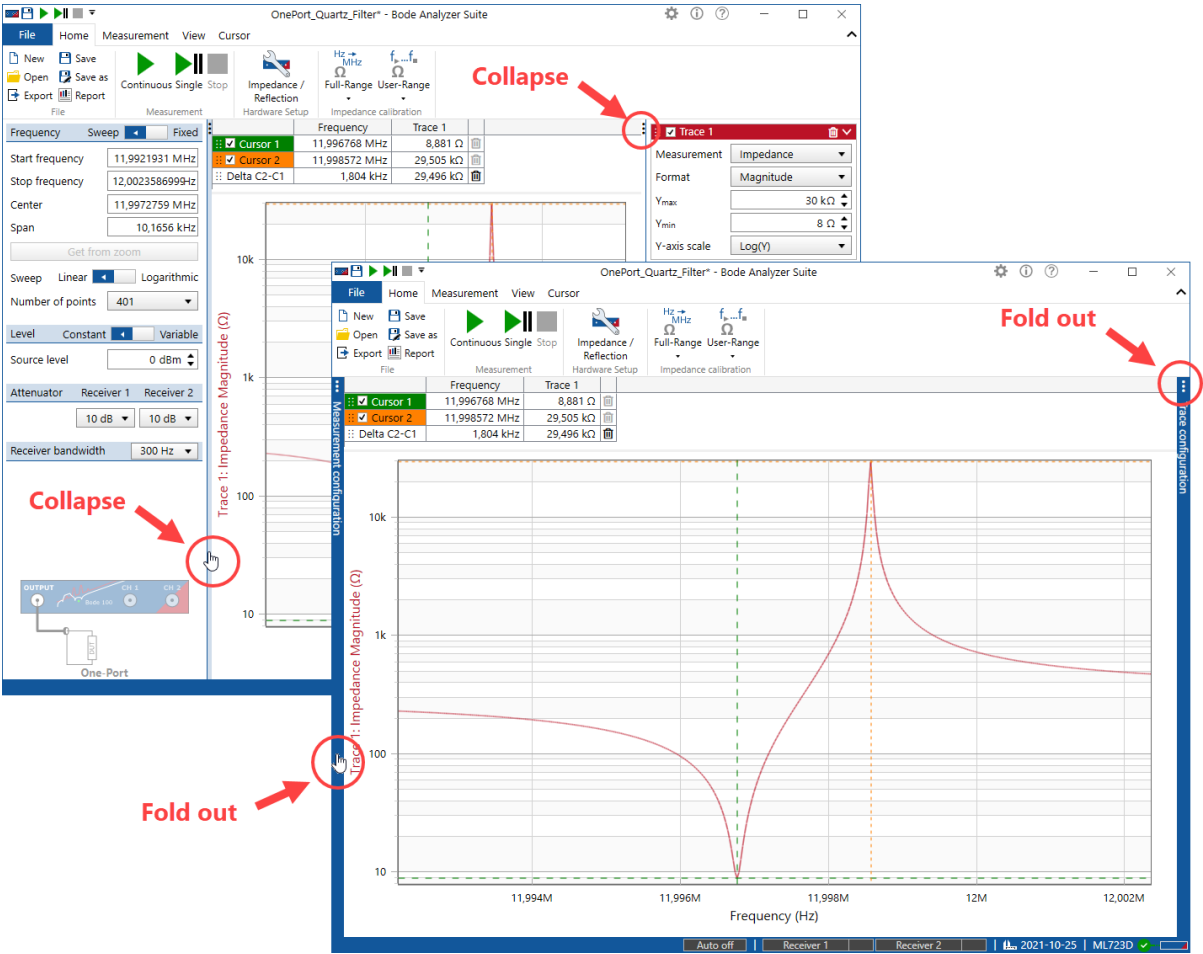







Figure 7-3: Collapsing the measurement and trace configuration areas

**Hint:** The width of the right trace settings region can be adjusted as desired. If you have long trace names, you can increase the width of the trace configuration region.

## 7.2.3 Ribbon controls

The *Bode Analyzer Suite* ribbons feature the following commands:

### Home ribbon



 <p>File</p>	<ul style="list-style-type: none"> <li>• New: Create a new measurement</li> <li>• Open: Open a different measurement file</li> <li>• Save: Save the current file</li> <li>• Save as: Choose a different file name to save file</li> <li>• Export: Export measurement data</li> <li>• Report: Create a PDF print-report</li> </ul> <p>A detailed explanation on the single file operations can be found in <a href="#">11.1 Exporting and saving measurement data or settings</a> on page 109.</p>
 <p>Continuous Single Stop</p> <p>Measurement</p>	<ul style="list-style-type: none"> <li>• Continuous: Starts a continuous measurement</li> <li>• Single: Performs one single measurement</li> <li>• Stop: Stops a running measurement</li> </ul>
 <p>Transmission / Gain Impedance / Reflection</p> <p>Hardware Setup</p>	<ul style="list-style-type: none"> <li>• Transmission/Gain: Open the hardware setup used for the gain measurement</li> <li>• Impedance/Reflection: Open the hardware setup used for the impedance measurement</li> </ul> <p>For more information regarding the hardware setup, please check out <a href="#">Hardware setup</a> .</p>
 <p>Full-Range User-Range</p> <p>Gain calibration</p>	<ul style="list-style-type: none"> <li>• Full-Range: Perform a Full-Range calibration</li> <li>• User-Range: Perform a User-Range calibration</li> </ul> <p>For more information regarding the calibration, please check out <a href="#">10 Calibration / Correction</a> on page 85</p>
 <p>Port extension</p> <p>Advanced</p>	<ul style="list-style-type: none"> <li>• Port-extension or port shifting can be used to mathematically move the reference plane in a reflection measurement. For more information, please check out: <a href="#">Port extension</a>.</li> </ul>

### Measurement ribbon

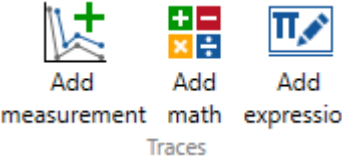

 <p>Memory</p>	<ul style="list-style-type: none"> <li>• Store the current measurement data to a new or existing memory trace.</li> <li>• <b>Show all</b> available memory traces in the diagram.</li> <li>• <b>Hide all</b> available memory traces. They will not be shown in the diagram.</li> <li>• <b>Delete all</b> memory traces.</li> </ul>
---	---

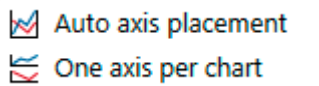
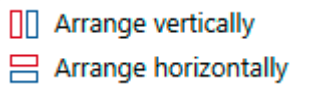
 <p>Add measurement    Add math    Add expression</p> <p>Traces</p>	<ul style="list-style-type: none"> <li>• <b>Add measurement:</b> Adds a new <i>Measurement trace</i>.</li> <li>• <b>Add math:</b> Adds a new <i>Math trace</i> for basic operations (+-*/).</li> <li>• <b>Add expression:</b> Adds a new <i>Expression trace</i> for advanced mathematical operations.</li> </ul> <p><b>i</b> Each trace comes with its <b>own axis</b>. A maximum of 2 axes can be combined in one chart using the <b>Auto axis placement</b> function in the <b>View</b> ribbon. If you prefer to have only one axis per chart, activate <b>One axis per chart</b> in the <b>View</b> ribbon.</p> <p>You can find more information about the use of Measurement, Math and Expression traces in <a href="#">11.5 Working with measurement and math traces</a> on page 134.</p>
<p>Instability Point:</p> <p>+1</p> <p>Stability Analysis</p>	<p>Select +1 or -1 to be the instability point or positive feedback point for the stability margin calculation or the closed-loop gridlines in the Nichols chart.</p>

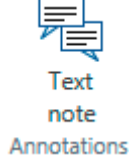
**View ribbon**

 <p>Auto axis placement</p> <p>One axis per chart</p>	<ul style="list-style-type: none"> <li>• Auto axis placement attempts to show two axes (traces) in one diagram.</li> <li>• One axis per chart shows a separate diagram for each trace. You can find more information in <a href="#">11.2.1 Configure the diagrams</a> on page 117. Select your preferred default setting in the <a href="#">options menu</a>.</li> </ul>
 <p>Arrange vertically</p> <p>Arrange horizontally</p>	<ul style="list-style-type: none"> <li>• Arrange multiple diagrams side by side.</li> <li>• Arrange multiple diagrams from top to bottom other.</li> </ul>
 <p>Average measurement</p>	<p>Activate averaging. More details can be found in <a href="#">11.8 Averaging</a> on page 150.</p>
 <p>Text note</p> <p>Annotations</p>	<p>Open a text field to add text notes to the current measurement.</p>

**Cursor ribbon**



 <p>Add Cursor    Add Delta Cursor Cursors</p>	<p>Add a cursor or a delta cursor. Each cursor will create a new line in the cursor table.</p>
 <p>None</p>	<p>Activate a cursor calculation. For more details please check out <a href="#">cursor calculations</a>.</p>
 <p>Link cursors</p>	<p>Activate cursor linking. Cursor linking maintains a constant distance between two cursors. By moving one cursor, the second one will follow automatically. Use this feature to e.g. measure the slope at crossover frequency in a bode plot. You can select either decade (x10) or octave (x2) or constant linear distance which will maintain the current frequency delta value.</p>

You can find more information about how to work with cursors in [11.3 Working with cursors and the cursor table](#) on page 125.

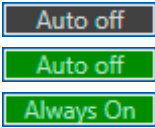
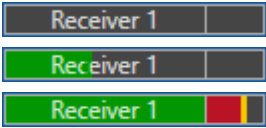
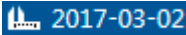

### 7.2.4 Status bar

The Status bar has several displays and interactive control elements. These are:

	<p><b>Source indicator</b></p> <p>The source indicator shows if the signal source of <i>Bode 100</i> is switched on. By <b>moving the mouse over the indicator</b>, a pop-up allows to change between <b>Auto off</b> and <b>Always on</b> setting. More details regarding the source setting can be found in <a href="#">9.4 Signal source settings</a> on page 80.</p>
	<p><b>Overload indicators</b></p> <p>The overload indicators show the signal level at the receivers of <i>Bode 100</i>. Red color indicates an overload of the receiver. An overload warning will be shown in the chart in such a case. More details about the overload indicator can be found in <a href="#">9.3 Choosing the receiver attenuator</a> on page 78.</p>
	<p><b>Internal device calibration indicator</b></p> <p>Shows the date of the last performed internal device calibration. <b>Move the mouse over the indicator</b> in order to perform a new internal device calibration. More details about the internal device calibration can be found in <a href="#">10.1 Internal device calibration</a> on page 85.</p>
	<p><b>Device connection indicator</b></p> <p>Displays the serial number of the connected device. If no device is connected, "No device" is shown. <b>Move the mouse over the indicator</b> in order to search or re-connect to a <i>Bode 100</i> device.</p>

## 7.3 Chart context menu

By right clicking into the chart you get access to a context menu that allows quick access to several functions:

	<p><b>Reset Zoom:</b> Resets the x-axis to the start and stop frequency and the y-axes to the predefined Ymin and Ymax values. See <a href="#">11.2.2 Zooming the measurement curve</a> on page 119 for details.</p>
	<p><b>Optimize:</b> Optimizes the Ymin and Ymax values once to ensure that the current measurement curve fills the chart area in an optimum way.</p>
	<p><b>Auto Optimize:</b> Optimizes the Ymin and Ymax values continuously to ensure that the measurement curve always fills the chart area in an optimum way.</p> <p><b>Reset Axes:</b> Resets the Y-axes to their predefined startup values.</p>
	<p>See <a href="#">11.2.3 Optimize the axis scaling / autoscale</a> on page 122 for detail on these functions.</p>
	<p><b>Copy image to clipboard:</b> Copies a image of the current chart to the clipboard.</p>
	<p><b>Copy data to clipboard:</b> Copies all measurement points of Trace 1 or Trace 2 to the clipboard for further processing in a spreadsheet software.</p>
	<p><b>Copy settings to clipboard:</b> Copies all measurement settings to the clipboard in text format.</p>
	<p>See <a href="#">11.1.2 Use the clipboard functions to export data</a> on page 109 for details on these functions.</p>
	<p><b>Cursor 1 &amp; Cursor 2:</b> Allows to access several cursor functions to position the cursors to the maximum, minimum or zero crossing of the measurement traces.</p> <p>See <a href="#">11.3 Working with cursors and the cursor table</a> on page 125 for details on these functions.</p>

## 7.4 Options menu

The Options menu allows you to modify several functions of the *Bode Analyzer Suite*. You can access the Options menu by either clicking the  icon in the top right corner of the *Bode Analyzer Suite*'s main window or by clicking **File** → **Options**.

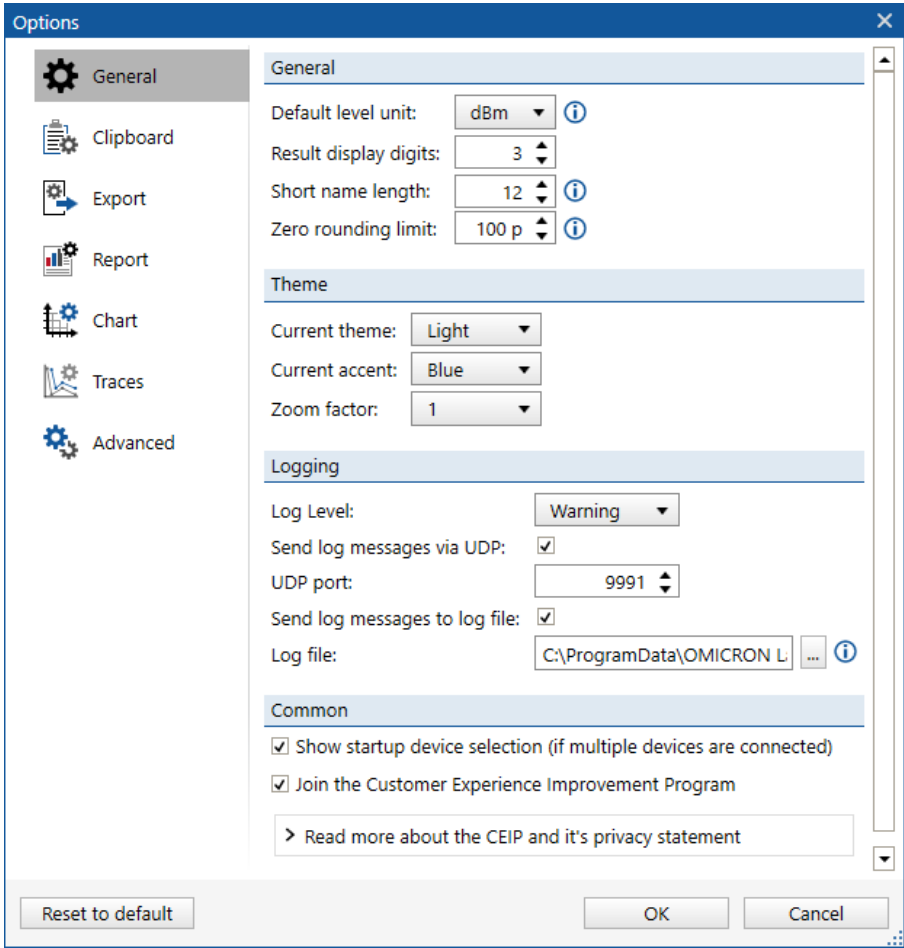









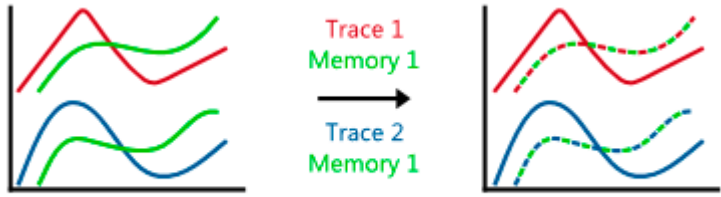



Figure 7-4: *Bode Analyzer Suite* Options menu

The options menu allows you to configure the following settings:

 General	<p><b>General:</b></p> <p><b>Default level unit:</b> allows you to change the unit for <i>Bode 100</i>'s source level setting. You can choose dBm, Vpp or Vrms.</p> <p> dBm defines the power dissipated into 50 Ω load. Vpp and Vrms are the voltage output levels present when a 50 Ω load is connected at the output. Due to the source's output impedance the output voltage will change depending on the impedance of the connected load. See more in <a href="#">9.4 Signal source settings</a> on page 80.</p> <p><b>Result display digits:</b> Defines the number of digits behind the decimal separator for values shown in the cursor grid and used for reporting.</p> <p><b>Short trace-name length:</b> This number defines how many letters are used for the name of a measurement or memory trace in the cursor grid, report and clipboarding.</p> <p><b>Zero rounding limit:</b> Values below this number will be displayed as zero. This setting applies to Phase (°) and Magnitude dB.</p> <p><b>Theme:</b></p> <p>Use the <b>Current theme</b> setting to switch between light and dark theme. Select your preferred accent color in <b>Current accent</b>. With the <b>Zoom factory</b> you can increase the size of the GUI for use on e.g. high-dpi screens.</p> <p><b>Logging:</b></p> <p><b>Log Level:</b> This function allows you to define the severity level of the events stored in the log-file. Default is <b>Warning</b>.</p> <p> Do not use the log-levels Verbose or Debug, except if told by the OMICRON Lab support team.</p> <p><b>UDP Logging:</b> allows you to enable event <b>logging via UDP</b> and to define the used <b>UDP port</b>.</p> <p><b>Logging to a file:</b> allows you to enable the logging of events to a <b>log file</b> and to define the <b>location</b> of the log file on your computer's hard drive.</p> <p><b>Common:</b></p> <p>Allows you to enable the device selection in the start up screen and to change your preference in relation to the Customer Experience Improvement Program.</p>
---	---

 <p>Clipboard</p>	<p><b>Chart:</b></p> <p>In this section you can optimize the <b>size of the text fonts</b> and the <b>thickness</b> of the measurement <b>traces</b> in the exported chart .</p> <p>Further on, you can enable the <b>inclusion</b> of the <b>chart legend</b> and the <b>cursor grid</b>. In addition the <b>position of the cursor grid</b> in the exported chart and the image <b>file format</b> can be defined.</p> <p><b>Data:</b></p> <p>In this section you can choose the <b>decimal separator</b> and the <b>field separator</b> for the clipboard export.</p> <p>Find more information in <a href="#">11.1.2 Use the clipboard functions to export data</a> on page 109.</p>
 <p>Export</p>	<p>In this section you can define several parameters for the <b>CSV-Export</b>, <b>Excel-Export</b> and <b>Touchstone-Export</b> of the measured data. These parameters are the default values that will be used for all future exports you perform.</p> <p>Find out more in <a href="#">11.1.4 Exporting measurement data to CSV or Excel files</a> on page 113.</p>
 <p>Report</p>	<p>Here you can choose if comments, the <b>cursor table</b>, the <b>chart legend</b> or <b>shaped level</b> are included in the report or not.</p> <p>Additionally, you can choose if you want to use a custom report or the standard report. Finally you can select if the report should be opened after its generation and the program that should be used to display the report.</p> <p>Detailed information is available in <a href="#">11.1.6 Generate a PDF report</a> on page 116.</p>

 Chart	<p>The sections in this area allow you to optimize the quality and appearance of the charts displayed in the <i>Bode Analyzer Suite</i>.</p> <p><b>General:</b></p> <p>Choose if <b>numbers in axis labels</b> are displayed in <b>Engineering</b> format (e.g. 1e3) or with <b>SI prefixes</b> (e.g. 1k). Use the <b>default axis placement setting</b> to choose if you prefer auto-axis placement or only one axis per chart.</p> <p><b>Logging:</b></p> <p>Further on, you can activate a <b>logger</b> that can be useful to find the reason for errors in the chart. Normally you only need this option when told by the OMICRON Lab support team.</p> <p><b>Render Settings:</b></p> <p>In case your chart does not show up correctly, please try to change the <b>Chart render mode</b>. Automatic is default and tries to use hardware rendering with DX11. In some rare cases with old graphics cards or problems with the graphics drivers, this can lead to problems. Try using hardware (DX9) or software rendering instead.</p> <p> Software rendering can significantly increase the processor usage on your system.</p>
 Traces	<p><b>General:</b></p> <p>Here you can select the <b>maximum number of memory traces</b>, the <b>default memory line pattern</b> (e.g. solid or dashed) as well as if the deletion of a memory trace needs to be confirmed or not.</p> <p><b>Alternating memory trace color mode:</b></p> <p>By enabling this mode you can make it easier to find out to which trace a memory belongs. If activated each memory alternates the memory color and the color of the trace it belongs to as shown below:</p> <div style="text-align: center;">  <p>Trace 1 Memory 1</p> <p>Trace 2 Memory 1</p> <p>disabled                      enabled</p> </div>

 Advanced	<p><b>Calibration / Correction:</b></p> <p>You can enable "live update" respectively "<b>recalculate measurement trace values retroactively</b>". This will recalculate the measurement trace values whenever a calibration-related parameter changes. The effect of disabling or enabling a calibration / correction will immediately be shown on the measurement result and not only used for new measurements. You can therefore see the influence of a correction on your results by enabling/disabling a calibration and watching the result change.</p> <p><b>Activate port extension</b> to switch on the Port extension feature. The icon will be shown in the Home ribbon. For more details, please refer to <a href="#">Port extension</a>.</p>
--	---



**Hint:** Click  to switch back to the default settings of all options at any time.

## 8 Measurement types and applications

*Bode 100* allows measuring Gain as well as Impedance, Reflection and Admittance. The following chapters introduce you to the basics of the [Gain](#) and [Impedance / Reflection / Admittance](#) measurements.

For an easy use, the *Bode Analyzer Suite* supports different measurement types / modes for different applications. The available measurements are listed in the start screen of the *Bode Analyzer Suite* (see [7.1 Start screen](#) on page 19).

The available measurement modes are grouped in the Vector Network Analysis Tab and the Impedance Analysis Tab:

### Vector Network Analysis

The Vector Network Analysis Tab contains the following measurement types:

1. [Transmission / Reflection](#)
2. [Gain / Phase](#)
3. [Reflection with external coupler](#)

### Impedance Analysis

The Impedance Analysis Tab contains the following measurement types:

1. [One-Port](#)
2. [Impedance Adapter](#)
3. [Shunt-Thru](#)
4. [Shunt-Thru with series resistance](#)
5. [Series-Thru](#)
6. [Voltage / Current](#)
7. [External Bridge](#)

In the following chapters all measurement types are explained in detail.



## 8.1 Gain measurement introduction

*Bode 100* offers two different ways of measuring Gain. Either with the internal reference or the external reference. Internal reference means that Receiver 1 is internally connected to the *Bode 100* signal source picking up the source voltage. External reference means that Receiver 1 is routed to the front panel input Channel 1.

Depending on the Receiver 1 connection, Gain is measured as shown in the following table:

Receiver 1 is set to internal reference	Receiver 1 is set to external reference
<p><i>Bode 100</i> measures</p> $Gain = \frac{V_{CH2}}{\frac{V_0}{2}}$ <p>Where <math>V_0</math> is the internal source voltage. If Channel 2 is terminated with 50 <math>\Omega</math> (default), Gain equals the scattering parameter S21 of a two-port DUT (Port 1 is connected to <i>Bode 100</i> output and port 2 is connected to <i>Bode 100</i> Channel 2).</p> <p> If Channel 2 is set to high-impedance, a Thru-connection from Output to Channel 2 will result in +6 dB. To normalize to 0 dB you can use Thru-calibration.</p>	<p><i>Bode 100</i> measures</p> $Gain = \frac{V_{CH2}}{V_{CH1}}$ <p>Gain therefore equals the transfer function of a 2-port DUT if Channel 1 is connected to the DUT input port and Channel 2 is connected to the DUT output port.</p>

The following two measurement modes can be used to perform a Gain measurement:

1. **Transmission / Reflection:** This mode allows both, measurements with internal and external reference connection.
2. **Gain / Phase:** Is used to measure Gain from Channel 1 to Channel 2 (Frequency Response Measurement).

Since the gain result is a complex number you can choose how gain shall be displayed. You can select the result formats by clicking the drop down **Format** in the trace configuration box.

In a gain measurement the following result formats are available:

### Gain Result Formats

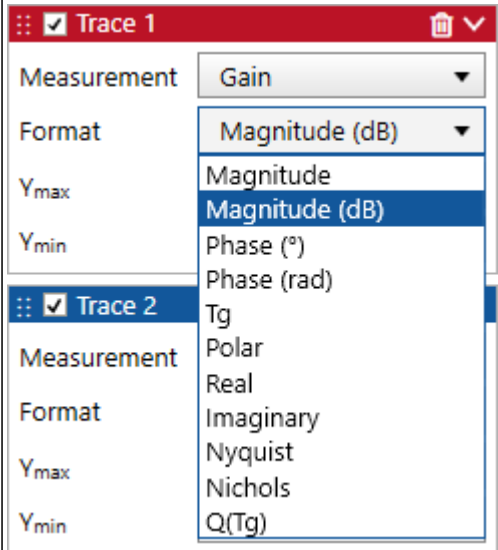
	<p><b>Magnitude:</b> Displays the magnitude of the measured Gain.</p> <p><b>Magnitude (dB):</b> Displays the magnitude of the measured Gain in dB</p> <p><b>Phase (°):</b> Displays the phase of the measured Gain in degrees.</p> <p><b>Phase (rad):</b> Displays the phase of the measured Gain in radians.</p> <p><b>Tg:</b> Displays the group delay of the measured Gain in seconds (see <a href="#">Gain result format equations</a> for details).</p> <p><b>Polar:</b> Displays the measured Gain in a polar chart.</p> <p><b>Real:</b> Displays the real part of the measured Gain.</p> <p><b>Imaginary:</b> Displays the imaginary part of the measured Gain.</p> <p><b>Nyquist:</b> Displays the measured Gain in a Nyquist chart.</p> <p><b>Nichols:</b> Displays Gain over Phase in the Nichols chart. Right-click into the chart to activate closed-loop gridlines.</p> <p><b>Q(Tg):</b> Displays the Q-factor derived from group delay. This value is used for NISM (see <a href="#">cursor calculations</a> on page 143 for details).</p>
---	--

### Gain result format equations

The Gain results are calculated based on the following equations:

**Gain  $H$ :**

$H = h \cdot e^{-j\varphi}$  where  $h$  is the magnitude of gain  $H$  and  $\varphi$  the phase of  $H$ .

$\omega$  is the angular frequency  $\omega = 2\pi f$  with the frequency  $f$ .

$$T_g = -\frac{d\varphi}{d\omega}$$

Group delay  $T_g$  is calculated by symmetric difference quotient

$$Q(T_g) = |\pi \cdot f \cdot T_g|$$

$Q(T_g)$  is the quality factor derived from the group delay

## 8.2 Impedance measurement introduction

*Bode 100* offers several ways of measuring Impedance, Reflection or Admittance. Impedance, Reflection and Admittance are directly related to each other by the following equations:

$$Y = \frac{1}{Z}$$

Admittance  $Y$  is the reciprocal of the impedance  $Z$  and vice versa.

$$Z = \frac{1}{Y}$$

$$\Gamma = \frac{Z - Z_0}{Z + Z_0}$$

The reflection coefficient  $\Gamma$  is calculated from the measured impedance  $Z$  and the nominal impedance  $Z_0$ .

$$Z = Z_0 \frac{1 + \Gamma}{1 - \Gamma}$$

The reflection coefficient  $\Gamma$  can be converted back to impedance  $Z$  via the nominal impedance  $Z_0$ .



$Z_0$  can be changed by the user in the measurement configuration. The nominal impedance  $Z_0$  field is only visible if a measurement trace is set to Reflection.

Nominal impedance

$Z_0$

50  $\Omega$

The Impedance Analysis modes allow you to display the measurement results in various formats. You can select the result formats by clicking the drop down **Format** in the trace configuration box. Depending on the chosen measurement the following result formats are available:

## Impedance Result Formats

<div style="border: 1px solid black; padding: 5px;"> <div style="background-color: #c00000; color: white; padding: 2px;">Trace 1</div> <div style="padding: 2px;">           Measurement: Impedance         </div> <div style="padding: 2px;">           Format: Magnitude (dB)         </div> <div style="padding: 2px;">           Y<sub>max</sub>: Magnitude         </div> <div style="padding: 2px;">           Y<sub>min</sub>: Magnitude (dB)         </div> </div>	<p><b>Magnitude:</b> Displays the magnitude of the measured impedance in Ohms.</p>
<div style="border: 1px solid black; padding: 5px;"> <div style="background-color: #c00000; color: white; padding: 2px;">Trace 2</div> <div style="padding: 2px;">           Measurement: Impedance         </div> <div style="padding: 2px;">           Format: Magnitude (dB)         </div> <div style="padding: 2px;">           Y<sub>max</sub>: Magnitude         </div> <div style="padding: 2px;">           Y<sub>min</sub>: Magnitude (dB)         </div> </div>	<p><b>Magnitude (dB):</b> Displays the magnitude of the measured impedance in dBΩ.</p>
<div style="border: 1px solid black; padding: 5px;"> <div style="background-color: #c00000; color: white; padding: 2px;">Trace 2</div> <div style="padding: 2px;">           Measurement: Impedance         </div> <div style="padding: 2px;">           Format: Magnitude (dB)         </div> <div style="padding: 2px;">           Y<sub>max</sub>: Magnitude         </div> <div style="padding: 2px;">           Y<sub>min</sub>: Magnitude (dB)         </div> </div>	<p><b>Phase (°):</b> Displays the phase of the measured impedance in degrees.</p>
<div style="border: 1px solid black; padding: 5px;"> <div style="background-color: #c00000; color: white; padding: 2px;">Trace 2</div> <div style="padding: 2px;">           Measurement: Impedance         </div> <div style="padding: 2px;">           Format: Magnitude (dB)         </div> <div style="padding: 2px;">           Y<sub>max</sub>: Magnitude         </div> <div style="padding: 2px;">           Y<sub>min</sub>: Magnitude (dB)         </div> </div>	<p><b>Phase (rad):</b> Displays the phase of the measured impedance in radians.</p>
<div style="border: 1px solid black; padding: 5px;"> <div style="background-color: #c00000; color: white; padding: 2px;">Trace 2</div> <div style="padding: 2px;">           Measurement: Impedance         </div> <div style="padding: 2px;">           Format: Magnitude (dB)         </div> <div style="padding: 2px;">           Y<sub>max</sub>: Magnitude         </div> <div style="padding: 2px;">           Y<sub>min</sub>: Magnitude (dB)         </div> </div>	<p><b>Tg:</b> Displays the group delay of the measured impedance in seconds (see <a href="#">Gain result equations</a> for details).</p>
<div style="border: 1px solid black; padding: 5px;"> <div style="background-color: #c00000; color: white; padding: 2px;">Trace 2</div> <div style="padding: 2px;">           Measurement: Impedance         </div> <div style="padding: 2px;">           Format: Magnitude (dB)         </div> <div style="padding: 2px;">           Y<sub>max</sub>: Magnitude         </div> <div style="padding: 2px;">           Y<sub>min</sub>: Magnitude (dB)         </div> </div>	<p><b>Polar:</b> Displays the measured impedance in a polar chart.</p>
<div style="border: 1px solid black; padding: 5px;"> <div style="background-color: #c00000; color: white; padding: 2px;">Trace 2</div> <div style="padding: 2px;">           Measurement: Impedance         </div> <div style="padding: 2px;">           Format: Magnitude (dB)         </div> <div style="padding: 2px;">           Y<sub>max</sub>: Magnitude         </div> <div style="padding: 2px;">           Y<sub>min</sub>: Magnitude (dB)         </div> </div>	<p><b>Real:</b> Displays the resistance of the measured impedance in Ohms.</p>
<div style="border: 1px solid black; padding: 5px;"> <div style="background-color: #c00000; color: white; padding: 2px;">Trace 2</div> <div style="padding: 2px;">           Measurement: Impedance         </div> <div style="padding: 2px;">           Format: Magnitude (dB)         </div> <div style="padding: 2px;">           Y<sub>max</sub>: Magnitude         </div> <div style="padding: 2px;">           Y<sub>min</sub>: Magnitude (dB)         </div> </div>	<p><b>Imaginary:</b> Displays the reactance of the measured impedance in Ohms.</p>
<div style="border: 1px solid black; padding: 5px;"> <div style="background-color: #c00000; color: white; padding: 2px;">Trace 2</div> <div style="padding: 2px;">           Measurement: Impedance         </div> <div style="padding: 2px;">           Format: Magnitude (dB)         </div> <div style="padding: 2px;">           Y<sub>max</sub>: Magnitude         </div> <div style="padding: 2px;">           Y<sub>min</sub>: Magnitude (dB)         </div> </div>	<p><b>Rs:</b> Displays the equivalent series resistance (ESR) of the measured impedance in Ω. This value equals the Real part of impedance.</p>
<div style="border: 1px solid black; padding: 5px;"> <div style="background-color: #c00000; color: white; padding: 2px;">Trace 2</div> <div style="padding: 2px;">           Measurement: Impedance         </div> <div style="padding: 2px;">           Format: Magnitude (dB)         </div> <div style="padding: 2px;">           Y<sub>max</sub>: Magnitude         </div> <div style="padding: 2px;">           Y<sub>min</sub>: Magnitude (dB)         </div> </div>	<p><b>Ls:</b> Displays the equivalent series inductance (ESL) of the measured impedance in Henry.</p>
<div style="border: 1px solid black; padding: 5px;"> <div style="background-color: #c00000; color: white; padding: 2px;">Trace 2</div> <div style="padding: 2px;">           Measurement: Impedance         </div> <div style="padding: 2px;">           Format: Magnitude (dB)         </div> <div style="padding: 2px;">           Y<sub>max</sub>: Magnitude         </div> <div style="padding: 2px;">           Y<sub>min</sub>: Magnitude (dB)         </div> </div>	<p><b>Cs:</b> Displays the equivalent series capacitance (ESC) of the measured impedance in Farad.</p>
<div style="border: 1px solid black; padding: 5px;"> <div style="background-color: #c00000; color: white; padding: 2px;">Trace 2</div> <div style="padding: 2px;">           Measurement: Impedance         </div> <div style="padding: 2px;">           Format: Magnitude (dB)         </div> <div style="padding: 2px;">           Y<sub>max</sub>: Magnitude         </div> <div style="padding: 2px;">           Y<sub>min</sub>: Magnitude (dB)         </div> </div>	<p><b>Q:</b> Displays the Q-factor of the measured impedance (see <a href="#">Impedance result equations</a> for details).</p>
<div style="border: 1px solid black; padding: 5px;"> <div style="background-color: #c00000; color: white; padding: 2px;">Trace 2</div> <div style="padding: 2px;">           Measurement: Impedance         </div> <div style="padding: 2px;">           Format: Magnitude (dB)         </div> <div style="padding: 2px;">           Y<sub>max</sub>: Magnitude         </div> <div style="padding: 2px;">           Y<sub>min</sub>: Magnitude (dB)         </div> </div>	<p><b>Nyquist:</b> Displays the measured impedance in a Nyquist chart</p>
<div style="border: 1px solid black; padding: 5px;"> <div style="background-color: #c00000; color: white; padding: 2px;">Trace 2</div> <div style="padding: 2px;">           Measurement: Impedance         </div> <div style="padding: 2px;">           Format: Magnitude (dB)         </div> <div style="padding: 2px;">           Y<sub>max</sub>: Magnitude         </div> <div style="padding: 2px;">           Y<sub>min</sub>: Magnitude (dB)         </div> </div>	<p><b>Q(Tg):</b> Displays the Q-factor derived from group delay. This value is used for NISM (see <a href="#">Cursor calculations</a> for details).</p>
<div style="border: 1px solid black; padding: 5px;"> <div style="background-color: #c00000; color: white; padding: 2px;">Trace 2</div> <div style="padding: 2px;">           Measurement: Impedance         </div> <div style="padding: 2px;">           Format: Magnitude (dB)         </div> <div style="padding: 2px;">           Y<sub>max</sub>: Magnitude         </div> <div style="padding: 2px;">           Y<sub>min</sub>: Magnitude (dB)         </div> </div>	<p><b>tan(δ):</b> Displays the tan(δ) of the measured admittance. (see <a href="#">Impedance result equations</a> for details).</p>

Admittance Result Formats

<p>Trace 1</p> <p>Measurement: Admittance</p> <p>Format: Magnitude (dB)</p> <p>Y<sub>max</sub>: Magnitude</p> <p>Y<sub>min</sub>: Magnitude (dB)</p>	<p><b>Magnitude:</b> Displays the magnitude of the measured admittance in Siemens.</p>
<p>Trace 2</p> <p>Measurement: Polar</p> <p>Format: Imaginary</p> <p>Y<sub>max</sub>: Rp</p> <p>Y<sub>min</sub>: Lp</p>	<p><b>Magnitude (dB):</b> Displays the magnitude of the measured admittance in dBS.</p>
	<p><b>Phase (°):</b> Displays the phase of the measured admittance in degrees</p>
	<p><b>Phase (rad):</b> Displays the phase of the measured admittance in radians</p>
	<p><b>Tg:</b> Displays the group delay of the measured admittance in seconds (see <a href="#">Gain result equations</a> for details).</p>
	<p><b>Polar:</b> Displays the measured admittance in a polar chart.</p>
	<p><b>Real:</b> Displays the conductance of the measured admittance in Siemens.</p>
	<p><b>Imaginary:</b> Displays the susceptance of the measured admittance in Siemens</p>
	<p><b>Rp:</b> Displays the equivalent parallel resistance of the measured admittance in Ohms.</p>
	<p><b>Lp:</b> Displays the equivalent parallel inductance of the measured admittance in Henry.</p>
	<p><b>Cs:</b> Displays the equivalent parallel capacitance of the measured admittance in Farad.</p>
	<p><b>Q:</b> Displays the Q-factor of the measured admittance (see <a href="#">Impedance result equations</a> for details).</p>
	<p><b>Nyquist:</b> Displays the measured admittance in a Nyquist chart.</p>
	<p><b>Q(Tg):</b> Displays the Q-factor derived from group delay (see <a href="#">Cursor calculations</a> for details).</p>
	<p><b>tan(δ):</b> Displays the tan(δ) of the measured admittance. (see <a href="#">Impedance result equations</a> for details)</p>

## Reflection Coefficient Result Formats

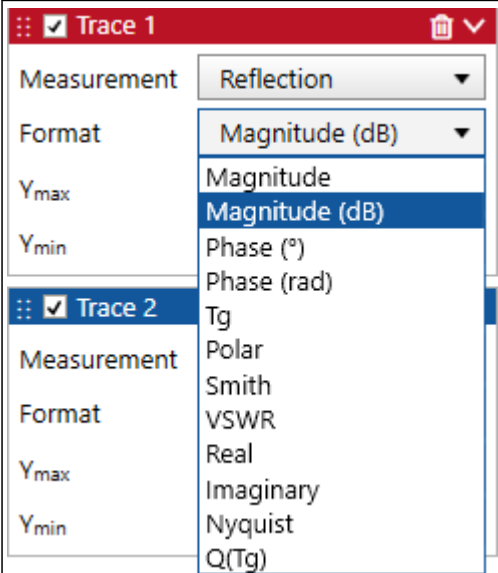
 <p>The screenshot shows a software interface with two traces. Trace 1 is selected and its format menu is open, listing various measurement options like Magnitude (dB), Phase (°), and Tg. Trace 2 is also visible with its own format menu.</p>	<p><b>Magnitude:</b> Displays the magnitude of the measured reflection coefficient.</p> <p><b>Magnitude (dB):</b> Displays the magnitude of the measured reflection coefficient in dB</p> <p><b>Phase (°):</b> Displays the phase of the measured reflection coefficient in degrees.</p> <p><b>Phase (rad):</b> Displays the phase of the measured reflection coefficient in radians.</p> <p><b>Tg:</b> Displays the group delay of the measured reflection coefficient in seconds (see <a href="#">Gain result equations</a> for details).</p> <p><b>Polar:</b> Displays the measured reflection coefficient in a polar chart.</p> <p><b>Smith:</b> Displays the measured reflection coefficient respectively impedance in a Smith chart.</p> <p><b>VSWR:</b> Displays the voltage standing wave ratio of the measured reflection coefficient.</p> <p><b>Real:</b> Displays the real part of the measured reflection coefficient.</p> <p><b>Imaginary:</b> Displays the imaginary part of the measured reflection coefficient.</p> <p><b>Nyquist:</b> Displays the reflection coefficient in a Nyquist chart.</p> <p><b>Q:</b> Displays the Q-factor of the measured reflection (see <a href="#">Impedance result equations</a> for details).</p> <p><b>Nyquist:</b> Displays the measured reflection in a Nyquist chart.</p> <p><b>Q(Tg):</b> Displays the Q-factor derived from the group delay (see <a href="#">Cursor calculations</a> for details).</p>
--	---

**Result format equations**

The Impedance / Admittance / Reflection results are calculated based on the following equations:

**Impedance Z:**

$Z = R + jX$  where  $R$  is the real part of the impedance (resistance) and  $X$  the imaginary part of the impedance (reactance).

$\omega$  is the angular frequency  $\omega = 2\pi f$  with the frequency  $f$ .

$R_s = R$  Series equivalent resistance  $R_s$  equals the real part of impedance

$C_s = -\frac{1}{\omega X}$  Series equivalent capacitance  $C_s$

$L_s = \frac{X}{\omega}$  Series equivalent inductance  $L_s$

$Q = \frac{|X|}{R}$  Series circuit quality factor  $Q$

$\tan(\delta) = \left| \frac{R}{X} \right|$   $\tan(d)$  of impedance

**Admittance Y:**

$Y = G + jB$  where  $G$  is the real part of the admittance (conductance) and  $B$  the imaginary part of the admittance (susceptance).

$\omega$  is the angular frequency  $\omega = 2\pi f$  with the frequency  $f$ .

$R_p = \frac{1}{G}$  Parallel equivalent resistance  $R_p$

$C_p = \frac{B}{\omega}$  Parallel equivalent capacitance  $C_p$

$L_p = -\frac{1}{\omega B}$  Parallel equivalent inductance  $L_p$

$Q = \frac{|B|}{G}$  Parallel circuit quality factor  $Q$

$\tan(\delta) = \left| \frac{G}{B} \right|$   $\tan(d)$  of admittance

**Reflection Coefficient  $\Gamma$ :**

$$VSWR = \frac{1 + |\Gamma|}{1 - |\Gamma|} \quad \text{Voltage Standing Wave Ratio VSWR}$$

Tg as well as Q(Tg) are calculated in the same way as for the gain measurement (see [8.1 Gain measurement introduction](#) on page 37).

## 8.3 Vector Network Analysis

### 8.3.1 Transmission / Reflection

The Transmission / Reflection measurement mode is designed to measure the S-parameters S21 and S11 in the 50  $\Omega$  domain.

Transmission / Reflection

Measure S-parameters (S21, S11) with 50  $\Omega$  termination.  
Measure Gain with internal or external reference.

 Do not exceed 3.3 V<sub>rms</sub> at the output (50  $\Omega$ ).  
Do not exceed 7 V<sub>rms</sub> at Channel 2 input (50  $\Omega$ ).

Select measurement

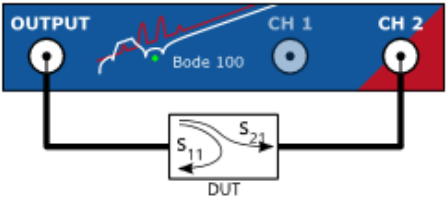

 The Transmission / Reflection measurement mode allows to measure both, Transmission (Gain) and Reflection (Impedance). It is possible to select e.g. a Gain measurement in Trace 1 and an Impedance measurement in Trace 2. *Bode 100* will then sequentially measure Gain and Impedance.

Therefore some hardware settings are available twice. Once for the Gain measurement and once for the Impedance measurement.

Also the hardware setup dialog is available twice. Once for the Gain measurement and once for the impedance measurement.

For details on how the Gain is calculated, please check [8.1 Gain measurement introduction](#) on page 37.

#### Calibration in the Transmission / Reflection measurement mode

The Transmission / Reflection measurement mode does not require calibration to perform a measurement. However, to remove the influence of your connection cables the measurement mode offers Gain (Thru) as well as Impedance (Open, Short, Load) calibration. Gain calibration applies to a Gain measurement and Impedance calibration applies to a Impedance/Reflection/Admittance measurement. When measuring at high frequency or with long cables it is strongly recommended to perform a calibration. For more details regarding the Gain calibration please refer to [10 Calibration / Correction](#) on page 85.



### Typical applications

Typical applications for the Transmission / Reflection measurement mode are:

- Measuring Transmission and Reflection of filters such as IF filters or EMI filters.
- Comparing results from measurements with internal and external reference connection (the Transmission / Reflection measurement mode is the only measurement mode that allows changing the Receiver 1 connection).
- Measuring Gain of RF amplifiers in the 50  $\Omega$  domain.

### Transmission / Reflection measurement example

Follow the steps described below to perform a Transmission / Reflection measurement:

Connect the test object "IF Filter" to *Bode 100* using two BNC cables as shown in the figure below.

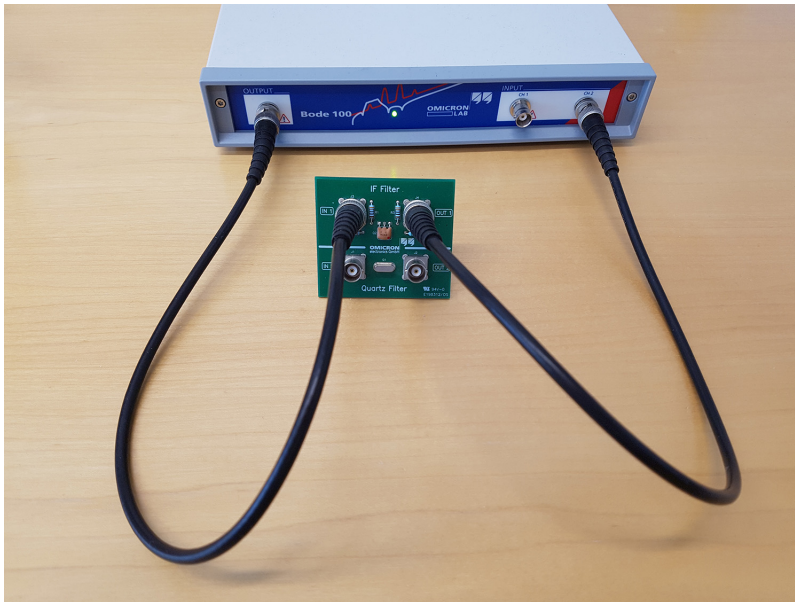

Figure 8-1: Connecting the test object IF Filter to *Bode 100*

Now start the *Bode Analyzer Suite* and enter the Transmission / Reflection measurement mode by clicking on .

▼ Transmission / Reflection

Measure S-parameters (S21, S11) with 50 Ω termination.  
Measure Gain with internal or external reference.

Do not exceed 3.3 V<sub>rms</sub> at the output (50 Ω).  
Do not exceed 7 V<sub>rms</sub> at Channel 2 input (50 Ω).

Select measurement

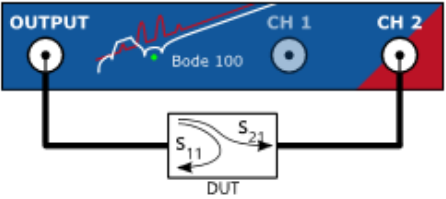

Before starting the measurement set the Start and Stop frequency to the values shown below:

Frequency	Sweep	Fixed
Start frequency	<input type="text" value="8,7 MHz"/>	
Stop frequency	<input type="text" value="12,7 MHz"/>	
Center	<input type="text" value="10,7 MHz"/>	
Span	<input type="text" value="4 MHz"/>	

After setting the Start and Stop frequency the Center frequency as well as the frequency Span are set automatically. Alternatively you can enter the Span and Center and the Start and Stop frequency are updated accordingly

Now you are ready to start your first measurement. Simply click  in the home ribbon. As a result you will see a first measurement comparable to the one shown in the figure below.

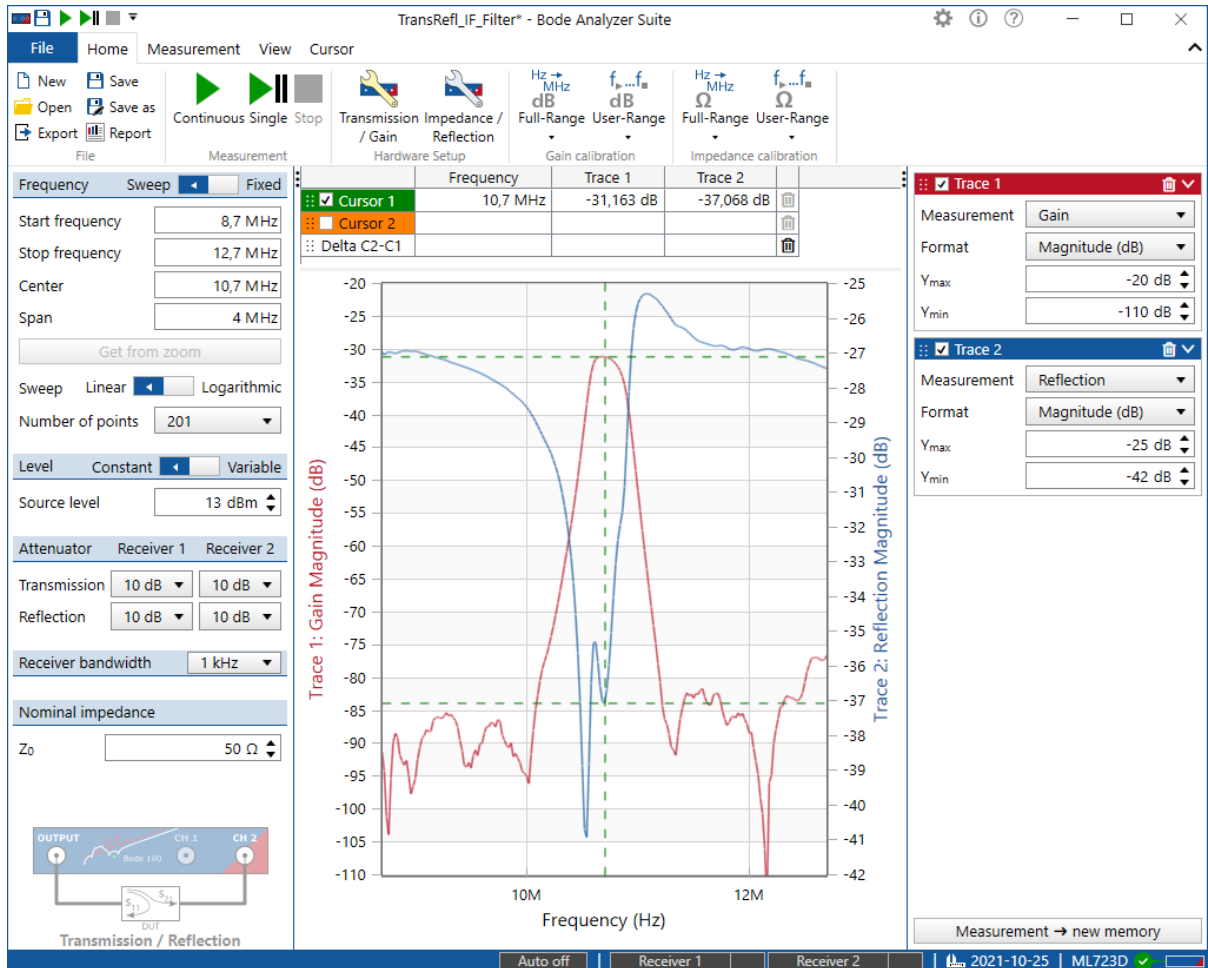

Figure 8-2: S-Parameter measurement of a 10.7 MHz IF filter

Trace 1 (red curve) shows the Magnitude of the Gain (= Magnitude of  $S_{21}$ ) while Trace 2 (blue curve) shows the Magnitude of Reflection (= Magnitude of  $S_{11}$ ). You can change Format for both traces to display other results such as Phase or Real and Imaginary components

To optimize the chart you can right click onto the chart and select **Optimize** as shown below. For more information on the chart's context menu check out [7.3 Chart context menu](#) on page 30.

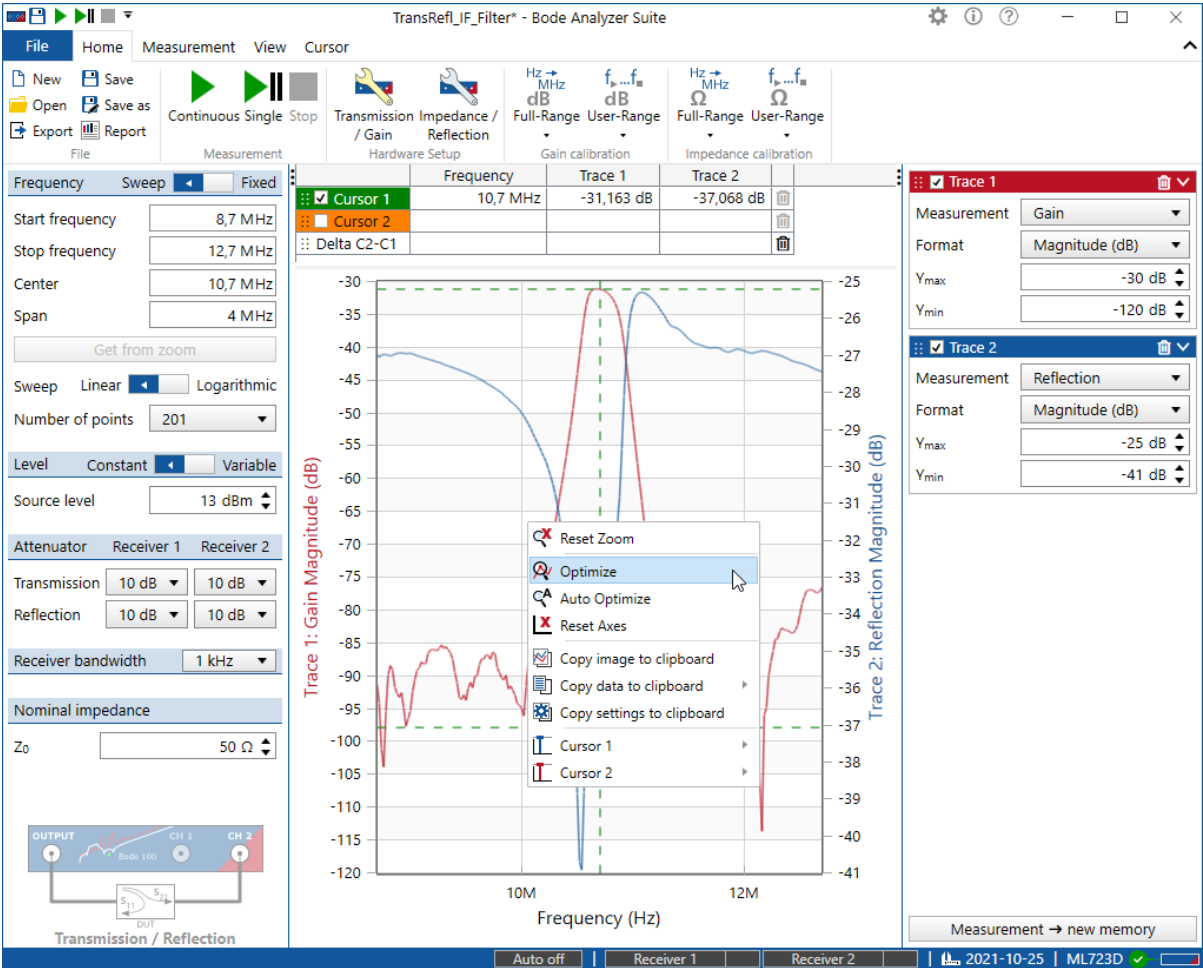

Figure 8-3: Context menu of chart

Further on you can use the cursors to perform measurements. To do so simply drag the cursors to the point you want to measure (1.) and check out the results in the cursor grid (2.) as shown in 8-4 on page 49. For more cursor functions visit [11.3 Working with cursors and the cursor table](#) on page 125.

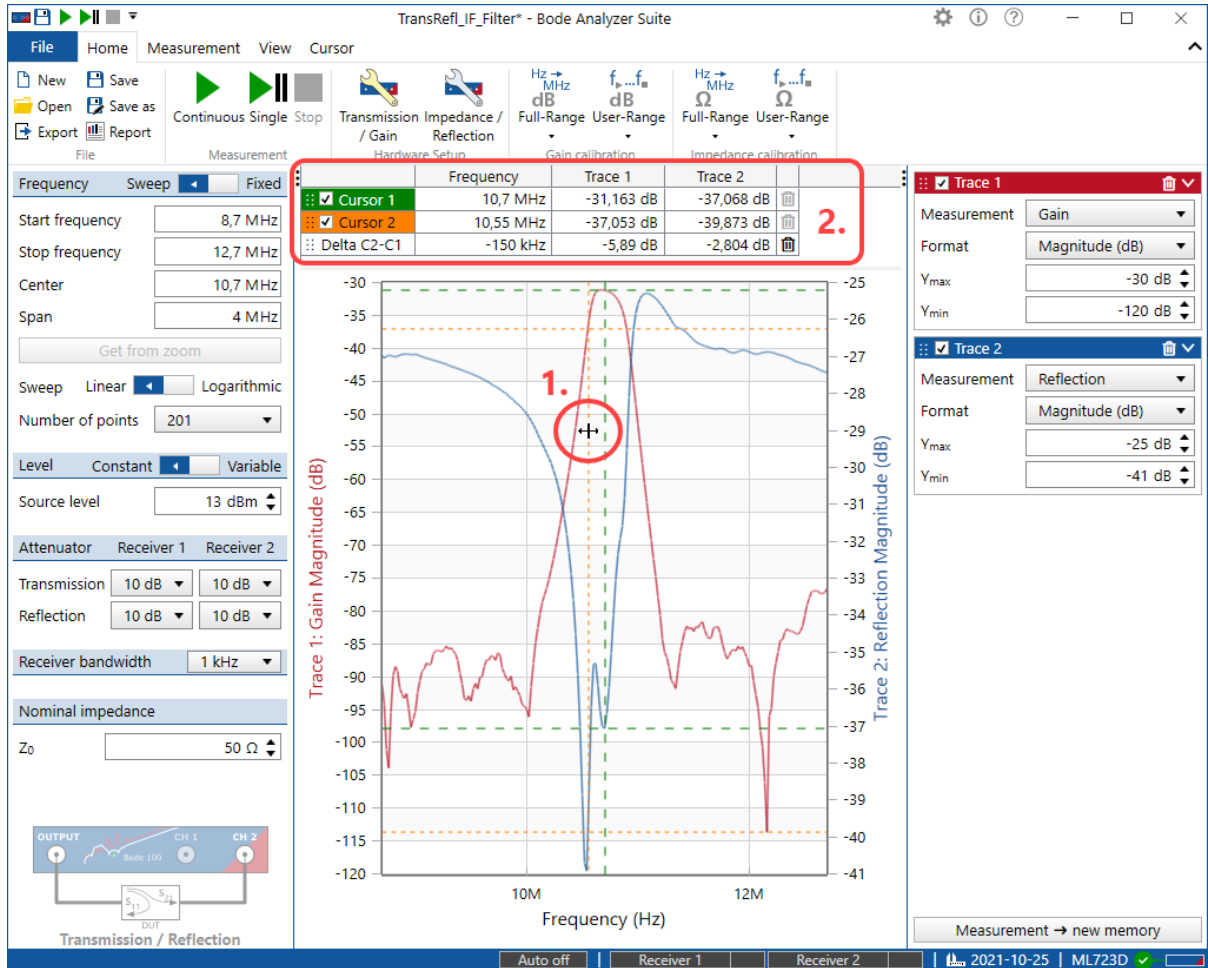

Figure 8-4: Use of cursors and cursor grid

**Congratulations** you have performed your first measurement with the *Bode 100*. You can load the settings for the measurement by clicking File → Open → and then navigating to: "%APPDATA%\OMICRON Lab\Bode Analyzer Suite\Demo Files\". The file you will need is: **TransRefI\_IF-Filter.bode3**



**Hint:** The Transmission / Reflection is the most flexible measurement setup for the *Bode 100*. By selecting this setup you can switch between internal and external reference. Further on, you can switch the input impedance of input CH1 and input CH2 between 50 Ω and high impedance.

## 8.3.2 Gain / Phase

The Gain / Phase measurement mode is designed to measure the transfer function of a DUT using the external reference connection. This means that both Channel 1 and Channel 2 are active.

▼ Gain / Phase

Measure transfer function (Gain/Phase) from CH1 to CH2.

 By default, the inputs are set to high impedance and are ac-coupled.  
Do not exceed 50 V<sub>DC</sub> at the inputs.  
Do not exceed 3.3 V<sub>RMS</sub> at the output (50 Ω).

Select measurement

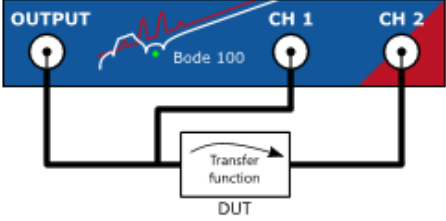

### The Gain Measurement

*Bode 100* measures

$$\text{Gain} = \frac{V_{CH2}}{V_{CH1}}$$

Gain therefore equals the transfer function of a 2-port DUT if Channel 1 is connected to the DUT input port and Channel 2 is connected to the DUT output port. The inputs Channel 1 and Channel 2 are set to 1 MΩ by default.

Details on the gain measurement can be found in [8.1 Gain measurement introduction](#) on page 37.

### Calibration

The Gain / Phase measurement mode does not require calibration to perform a measurement. However, to remove the influence of probes and cables Gain (Thru) calibration is recommended. For more details regarding the Gain calibration please refer to [10 Calibration / Correction](#) on page 85.

### Typical applications

Typical applications for the Gain / Phase measurement mode are:

- Measuring the transfer function of filters or other circuits.
- Measuring in-circuit transfer functions using high-impedance probes.
- Measuring the transfer function of amplifiers etc.
- Measuring loop stability of power supplies.

### Measurement example

For detailed measurement examples using the Gain / Phase measurement mode, please check out the application notes at [www.omicron-lab.com/BodeManualAppNotes](http://www.omicron-lab.com/BodeManualAppNotes). The following application notes use the Gain / Phase measurement mode:

- DC/DC Converter Stability Measurements
- Bipolar Transistor AC Current Gain Measurement
- Op-Amp measurements
- PSRR Measurement
- And many more...

### 8.3.3 Reflection with external coupler

The External coupler measurement mode is designed to measure reflection using an external coupler. This offers the possibility to use an external amplifier and protect the inputs of *Bode 100* by using an external directional coupler.

▼ Reflection with external coupler

Measure reflection using a directional coupler.

*Note: Calibration (open, short, load) is required.*

 Do not exceed 7 V<sub>rms</sub> at the inputs (50 Ω).

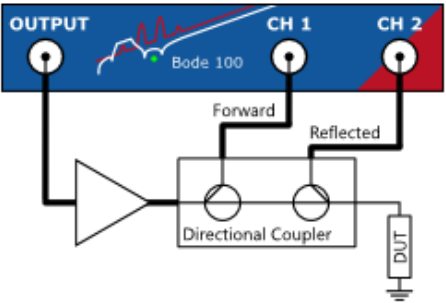

Select measurement

#### Calibration

Please note that the external coupler measurement mode requires an impedance calibration (Open, Short, Load). For more details on how to perform an impedance calibration see [10.3.2 Calibrating an External Coupler or External Bridge measurement](#) on page 96.

#### Typical applications

Typical applications for the external coupler measurement mode are:

- Measuring medium-wave antennas.
- Measuring impedance with high-power amplifiers.

#### Measurement example

For a detailed measurement example using the external coupler measurement mode, please check out the medium wave antenna measurement application note at [www.omicron-lab.com/BodeManualAppNotes](http://www.omicron-lab.com/BodeManualAppNotes).

# 8.4 Impedance analysis

## 8.4.1 One-Port

The One-Port measurement mode is designed to perform quick impedance, admittance and reflection measurements. One advantage of the One-Port impedance measurement mode is that no external calibration is required. *Bode 100* can measure impedance directly at the output port.

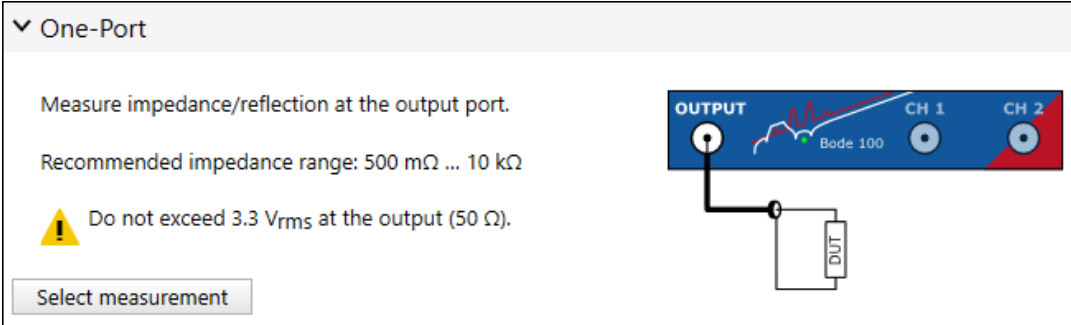

### Measurement information

*Bode 100* derives the impedance by evaluating the internal source voltage and the output voltage. Receiver 1 as well as Receiver 2 are internally connected. General details on impedance measurements with *Bode 100* can be found in [8.2 Impedance measurement introduction](#) on page 39.

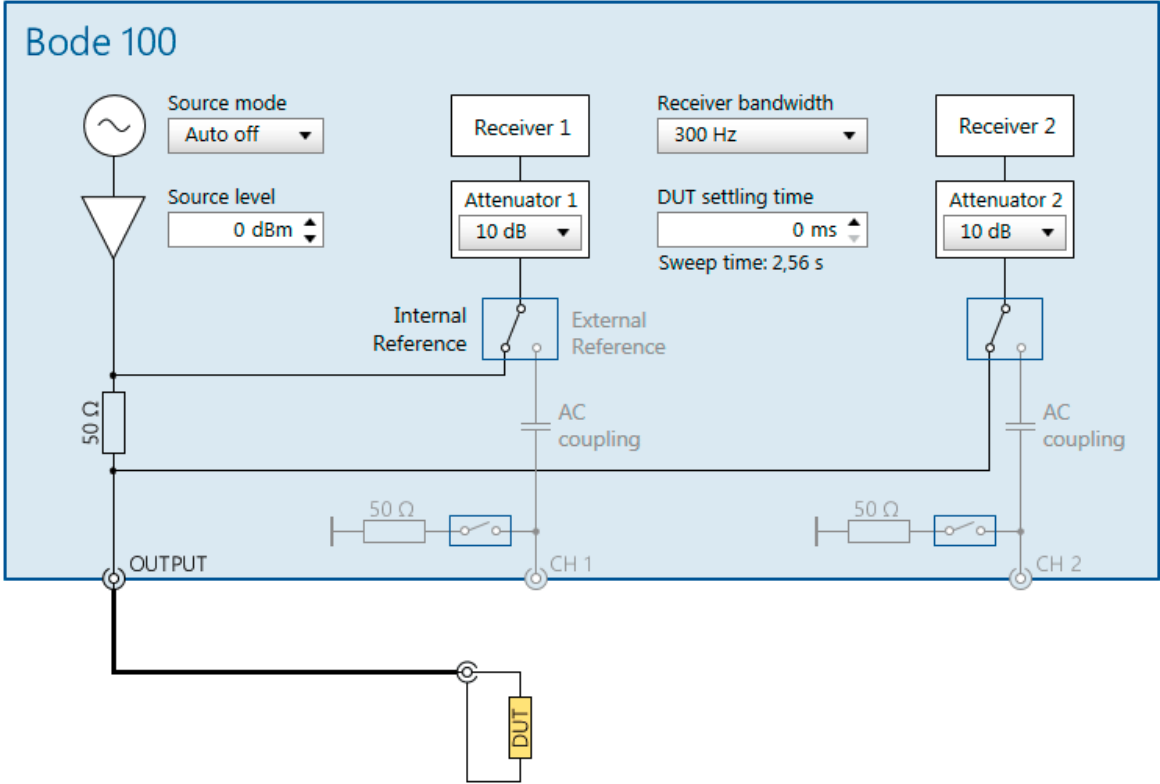

Figure 8-5: Hardware setup of the One-Port measurement mode.



Since the output impedance of *Bode 100* is  $50\ \Omega$ , the one-port measurement provides highest sensitivity for a DUT having an impedance close to  $50\ \Omega$ . The method is generally suitable to measure impedance values between roughly  $500\ \text{m}\Omega$  and  $10\ \text{k}\Omega$ .

For measurements close to the limits of this method it is highly recommended to perform a careful User-Range calibration to achieve best results.

### Calibration

The One-Port impedance measurement mode does not require calibration to perform a measurement. However, to achieve highest accuracy a calibration is recommended. Furthermore a calibration allows to move the reference plane from the output port of *Bode 100* to the end of a connection cable. This compensates the effect of the connection cable.

For more details on how to perform an Impedance calibration please refer to [10.3.1 Calibrating a Reflection or One-Port Impedance measurement](#) on page 94.

### Typical applications

Typical applications for the One-Port impedance measurement mode are:

- Measuring impedance of passive components.
- Measuring impedance of cables, piezo-elements or any one-port DUT.

### One-Port measurement example

In this measurement example we will determine the series and parallel resonance frequency of a 12 MHz quartz filter. Further on, we will display the quartz filter's reflection curve in a Smith chart. Connect the input **IN 2** of the test object "Quartz Filter" to the OUTPUT of *Bode 100* using a BNC cable. Further on, connect the BNC short delivered with *Bode 100* to the corresponding output **OUT 2**. The complete setup is shown in the figure below.

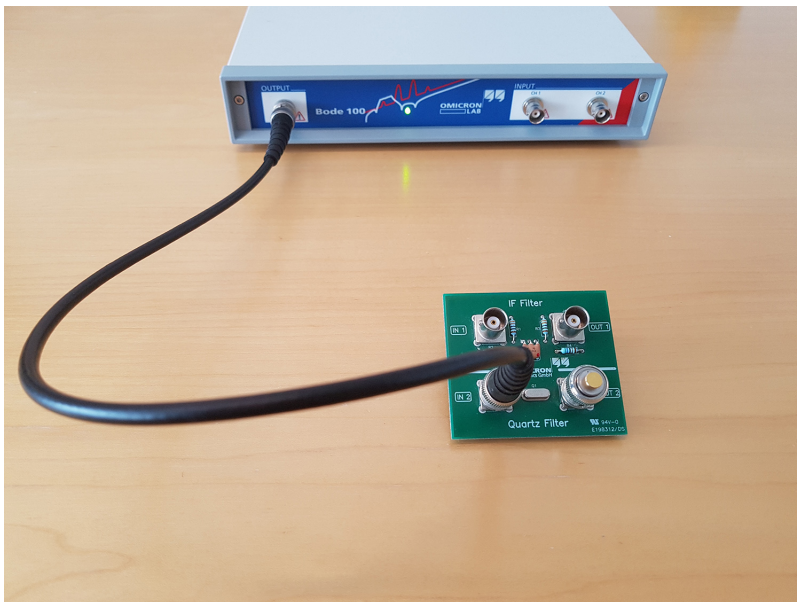
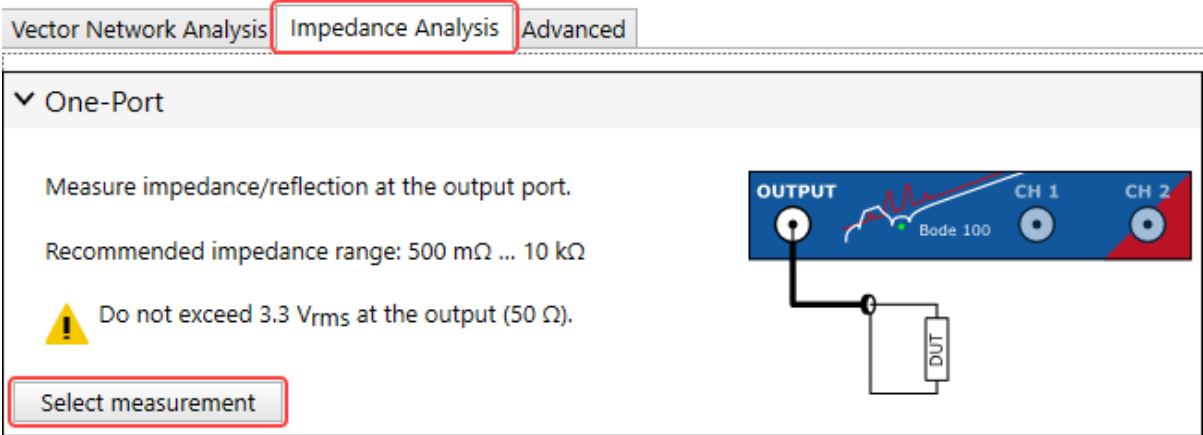

Figure 8-6: Connecting the test object Quartz Filter to *Bode 100*

Now start the *Bode Analyzer Suite* and enter the One-Port measurement mode by clicking Impedance Analysis and then .



Before starting the measurement set the **Center frequency**, **frequency Span** and the **Number of points** to the values shown below.

Further on, select **sweep linear**:

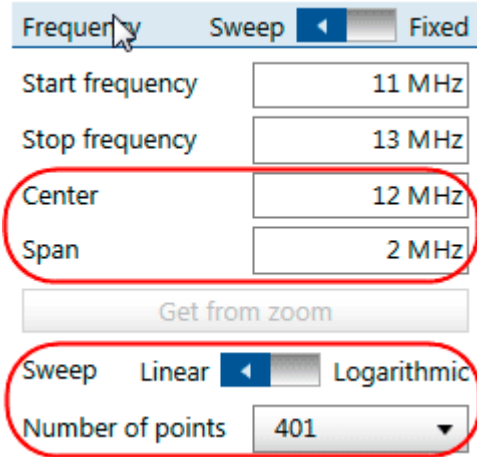

Now click  in the home ribbon. As a result you will see a first measurement comparable to the one shown in the figure below.

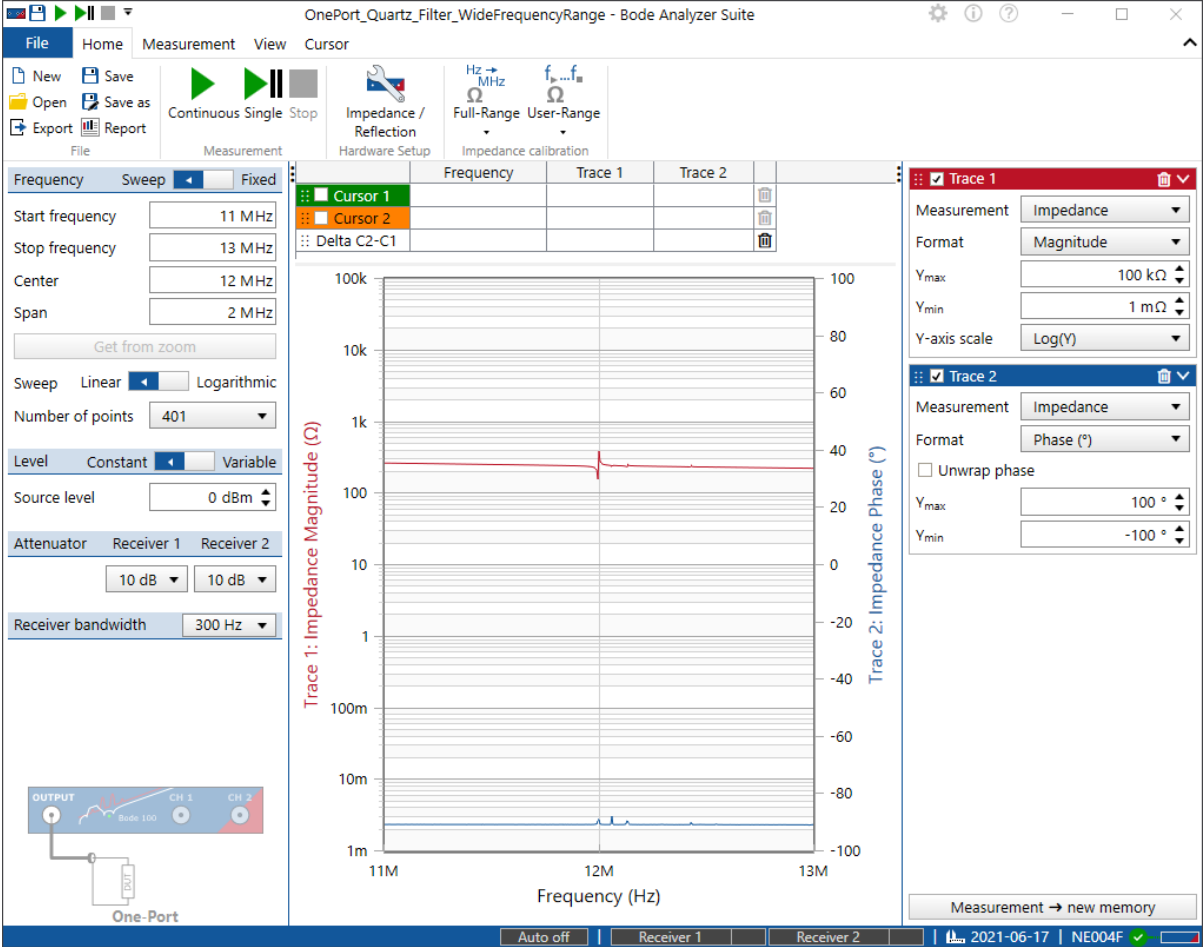
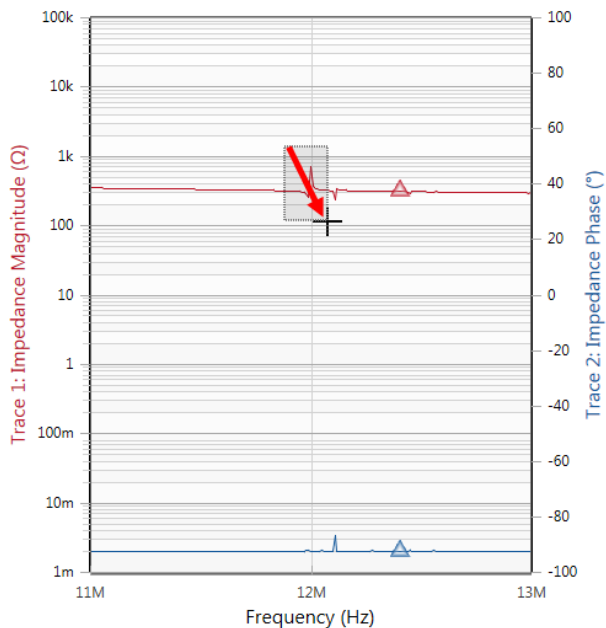

Figure 8-7: Impedance measurement of the test object Quartz Filter

Trace 1 (red curve) shows the Magnitude of the Quartz Filter's impedance while Trace 2 (blue curve) shows the Phase of the Quartz Filter's impedance.

Before continuing the measurement please switch of Trace 2 by unchecking the corresponding check box  Trace 2.

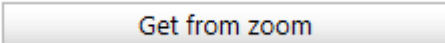

To determine the parallel and series resonance of the Quartz filter we need to zoom in. You can do this by clicking into the chart on the top left corner of the intended zoom area, keep the mouse button pressed and pull it to the lower right corner of the intended zoom area as shown.

In the zoomed window you will see that you are not having enough frequency points. By pressing  you can set the start and stop frequency of the measurement to match the zoomed window. Right Click into the chart and select **Optimize**. Repeat these steps until you achieve a chart as shown in 8-8 on page 56

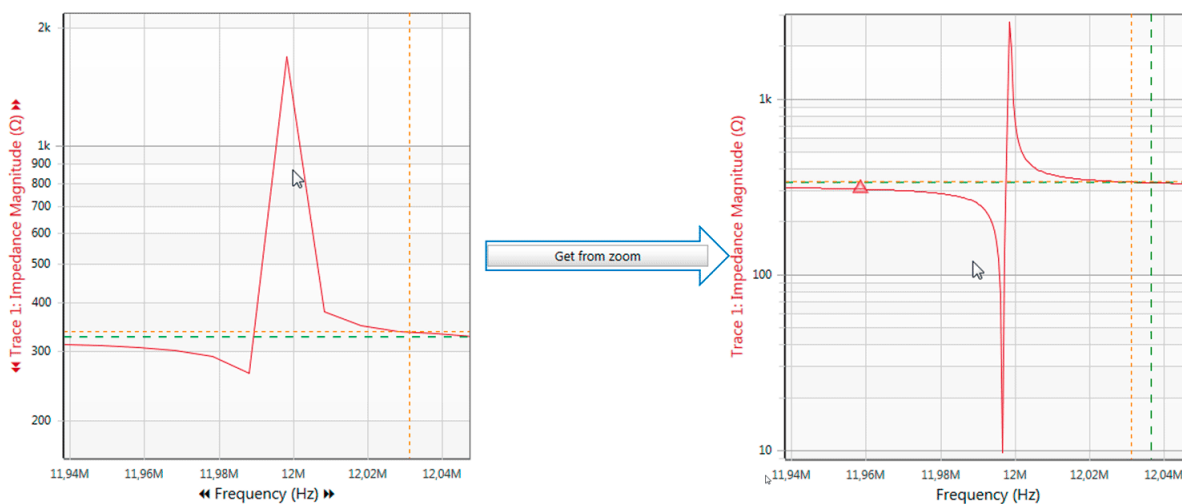

Figure 8-8: Optimizing the frequency resolution with Get from zoom

For more information on the zoom functions and optimizing check out [11.2.2 Zooming the measurement curve](#) on page 119 and [7.3 Chart context menu](#) on page 30.

After you have optimized the chart you can measure the series resonance and parallel resonance using the cursors. To do so right-click into the chart area close to the red curve and choose **Cursor 1** and then **Jump to Min (Trace 1)**. Then right-click into the chart area once more and choose **Cursor 2** and then **Jump to Max (Trace 1)**

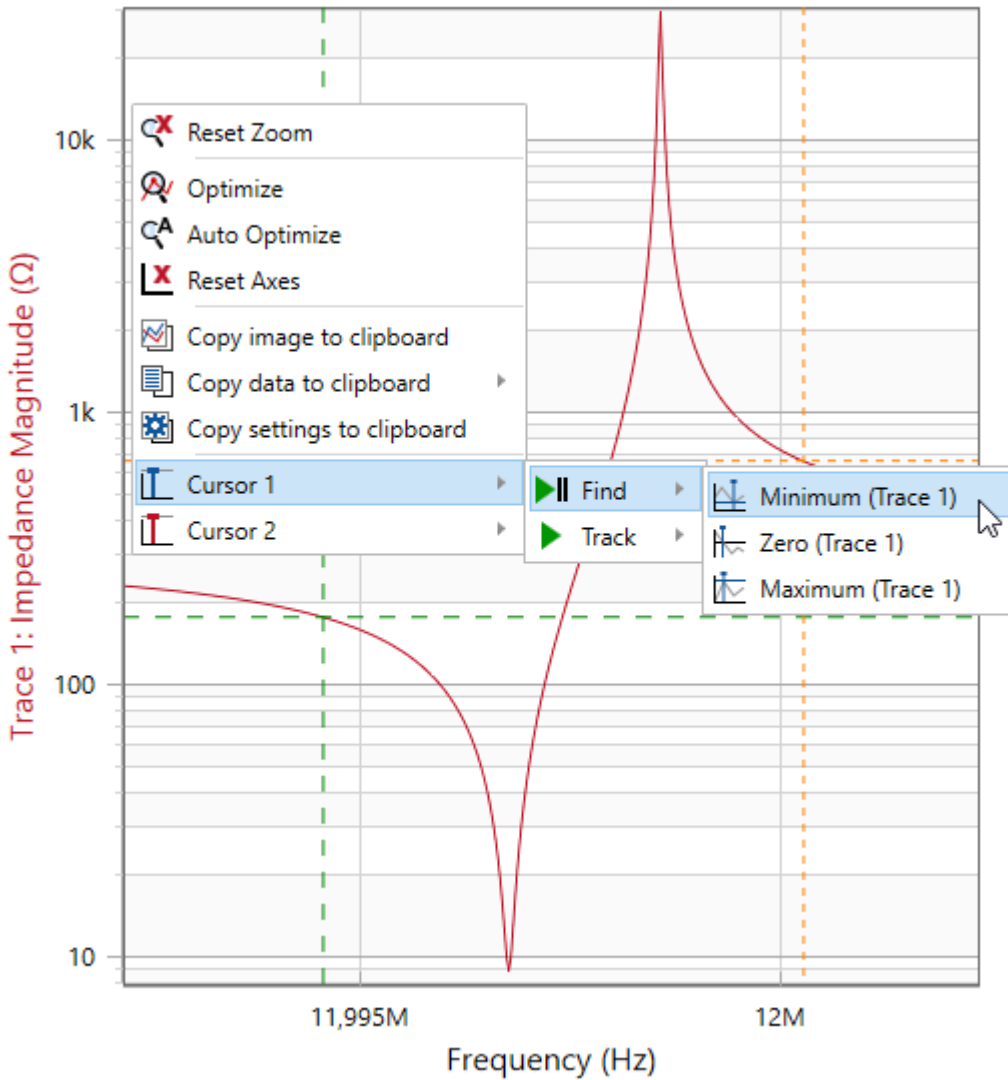

Figure 8-9: Using the cursor jump functions

For more information on cursor functions visit [11.3 Working with cursors and the cursor table](#) on page 125.

Now let's have a look at the measurement result:

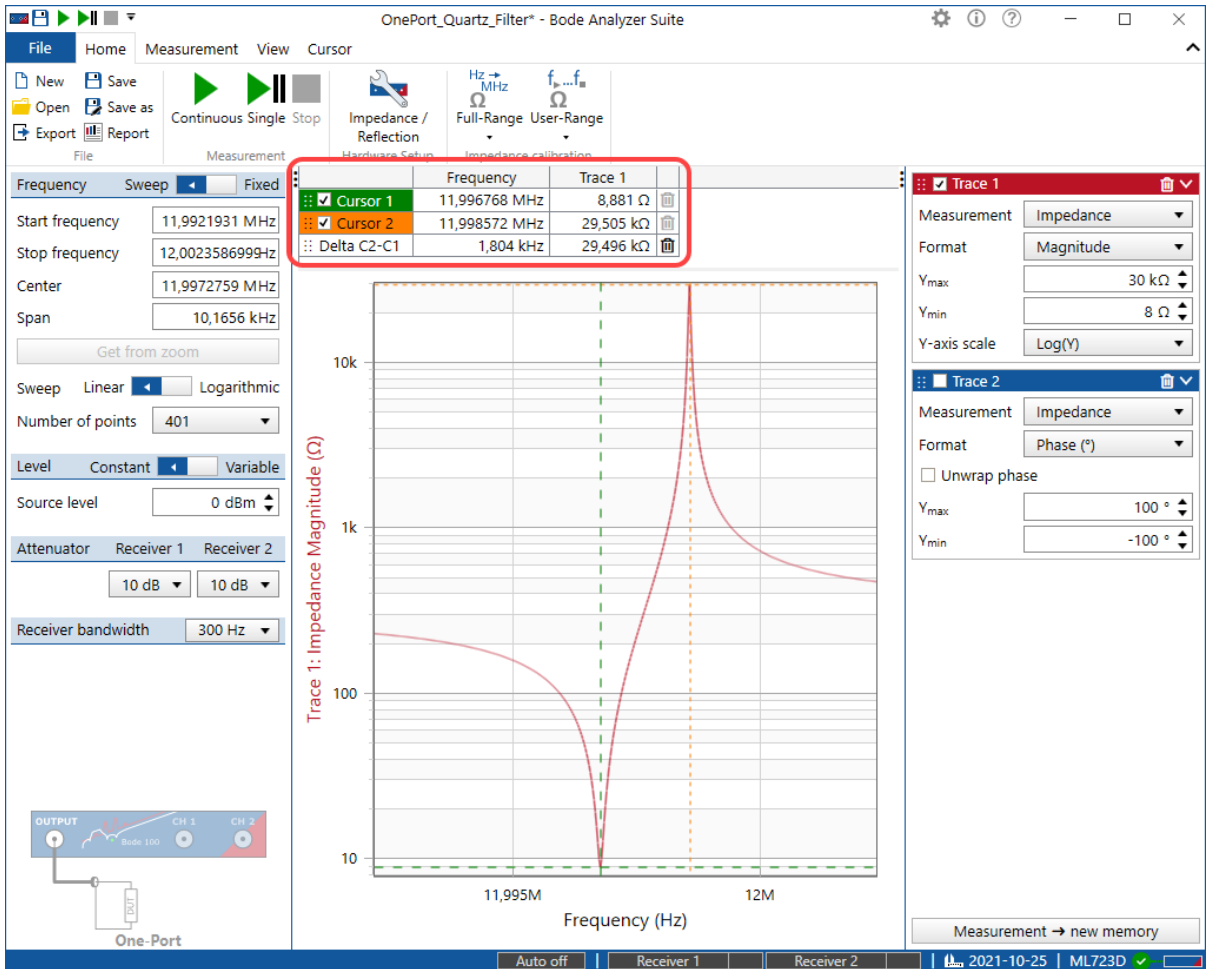

Figure 8-10: Series and parallel resonance frequency of the quartz filter

To determine the series and parallel resonance frequencies check out the cursor grid as shown in 8-8 on page 56:

- Series resonance frequency (Cursor 1 - green): 11.996768 MHz
- Parallel resonance frequency (Cursor 2 - orange): 11.998572 MHz
- Offset between the series and parallel resonance frequency (Delta C2-C1): 1.8 kHz

**i** Your measurement results can be slightly different since each quartz filter behaves a little bit different.

One characteristic of resonance frequencies is that the inductances and capacitances compensate each other. This means that at the series and parallel resonance the impedance of our quartz filter should be purely resistive. An elegant way to check this is to display the quartz filters reflection curve as a Smith chart.

Smith charts were developed at a time when it was still difficult to directly measure the frequency swept impedance of measurement objects. The Smith chart is used to determine the impedance at a certain point of the reflection curve. To display the Smith chart of our quartz filter's impedance apply the settings shown below to Trace 1:

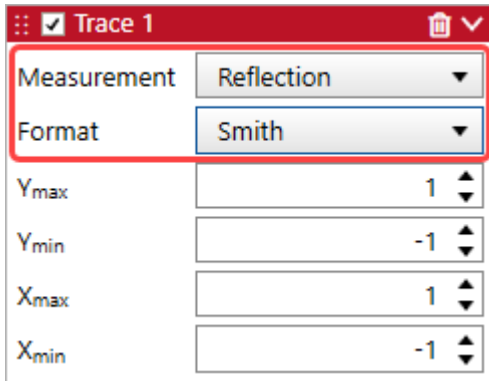

After applying the settings a smith chart like the one shown below will be displayed:

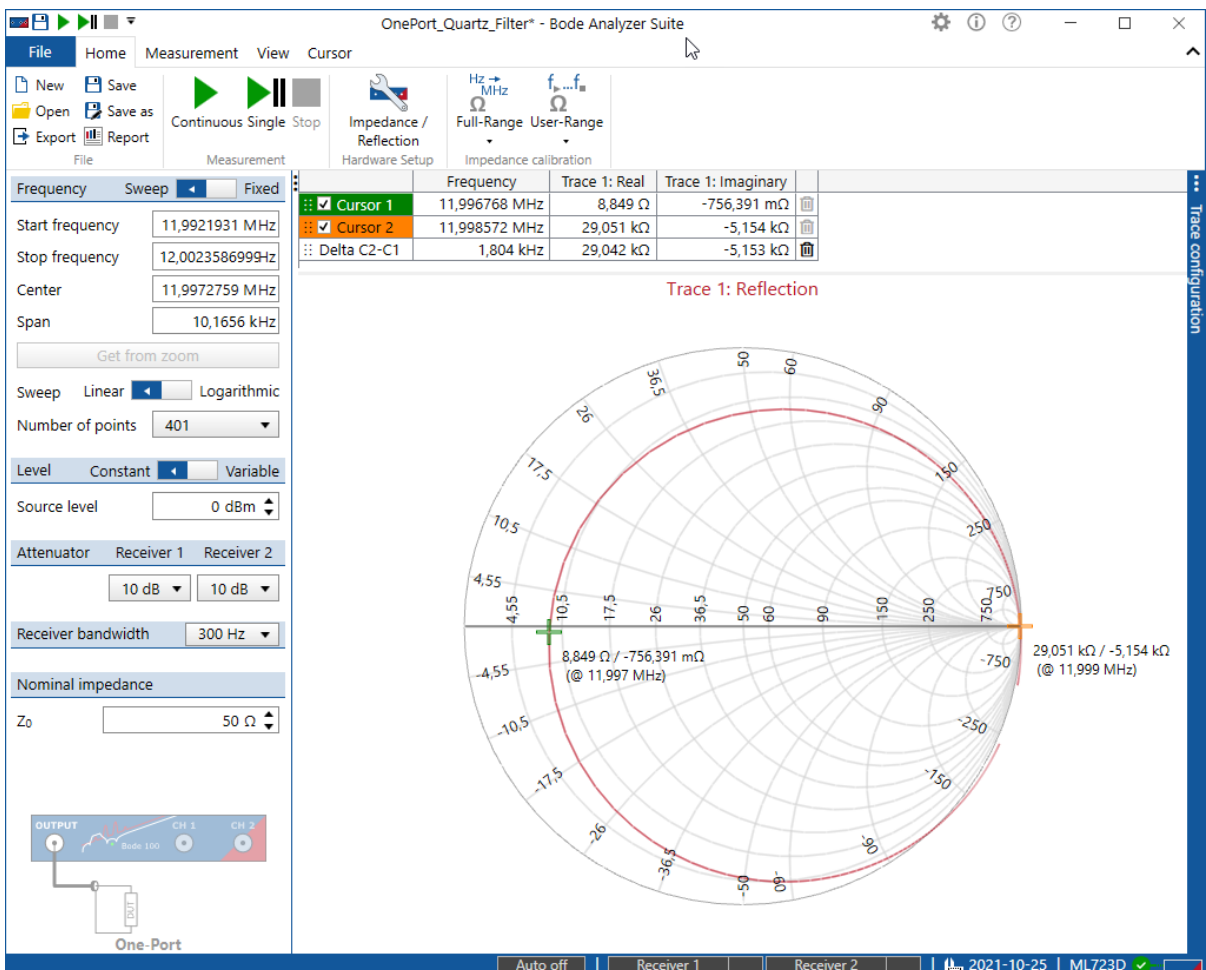

Figure 8-11: Smith chart of the 12 MHz Quartz Filter

As you can see both cursors are very close to the horizontal (=resistive) axis of the Smith chart. However, you can also see that the imaginary part for both measurements is not exactly 0  $\Omega$ . The reason for this is the chosen number of frequency points and the frequency resolution resulting from it. Fell free to use more points and zooming to determine the exact frequencies at which the imaginary part of the impedance becomes 0  $\Omega$

**Congratulations** you have performed your impedance measurement with the *Bode 100*. You can load the settings for the measurement by clicking File → Open → and then navigating to: "*%APPDATA%\OMICRON Lab\Bode Analyzer Suite\Demo Files\*". The file you will need is: **OnePort\_Quartz-Filter.bode3**.



## 8.4.2 Impedance Adapter

The impedance adapter measurement mode is especially designed for measurements with the OMICRON Lab impedance test fixtures *B-WIC* and *B-SMC*. The impedance adapter measurement mode ensures that *Bode 100* is configured correctly to achieve best results when measuring with both *B-WIC* and *B-SMC*.

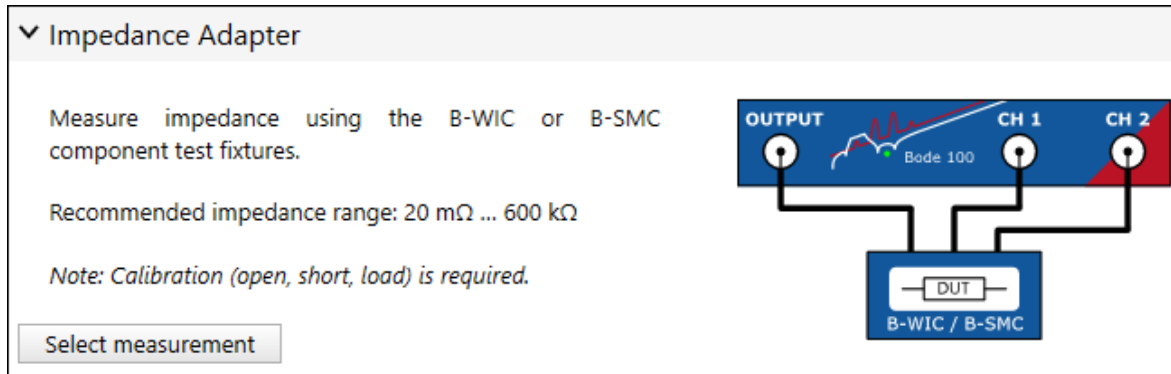

### Calibration

The impedance adapter measurement mode requires impedance (open, short, load) calibration. For more details on how to calibrate the *B-WIC* or *B-SMC* impedance adapter, please refer to [10.3.3 Calibrating an Impedance Adapter measurement](#) on page 98.

### Measurement information

With *B-WIC* and *B-SMC*, the dynamic range of both input channels is used. This widens the usable impedance measurement range to 20 mΩ to 600 kΩ.

It is recommended to use the 0.5 m BNC cables delivered with *Bode 100* to connect *B-WIC* or *B-SMC* to the *Bode 100*.

*B-WIC* and *B-SMC* are designed to measure physically small DUTs. Stray-fields between the DUT and the grounded housing of the impedance adapters might introduce a systematic measurement error. The error is negligible when measuring physically small objects. To measure physically big DUTs it is recommended to use a grounded measurement configuration such as shown in [8.2.1 One-Port](#) on page 52.

### Typical applications

Typical applications for the impedance adapter measurement mode are:

- Measuring impedance of capacitors, inductors and other passives (THT and SMC).
- Measuring impedance piezo-elements or quartz elements.

**Impedance Adapter measurement example**

In this measurement example we will determine the inductance ( $L_s$ ) and the equivalent series resistance ( $R_s$ ) of an inductance with the *B-WIC* impedance measurement adapter for through-hole-type components. Connect the *B-WIC* to *Bode 100* using three BNC cables as shown below.

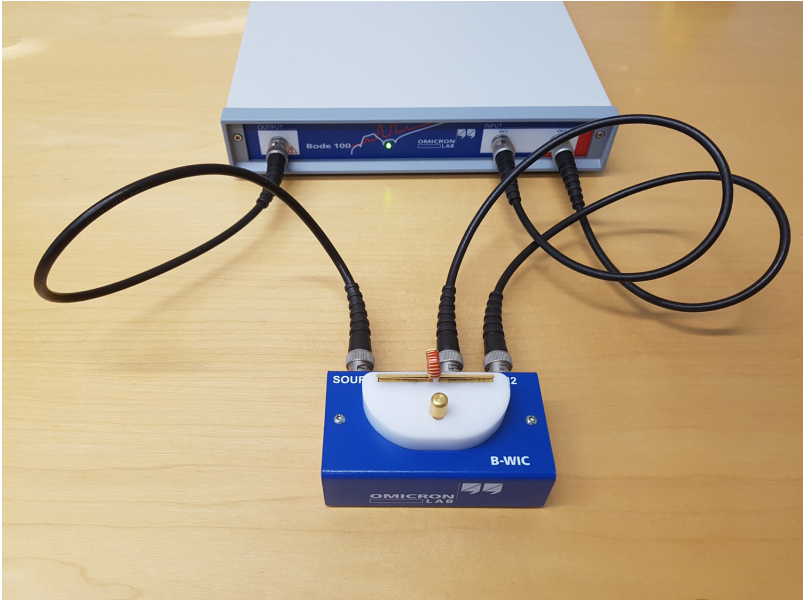

Figure 8-12: Connecting the *B-WIC* to *Bode 100*

Now start the Bode Analyzer Suite and enter the Impedance Adapter measurement mode by clicking Impedance Analysis and then  .

▼ Impedance Adapter

Measure impedance using the B-WIC or B-SMC component test fixtures.

Recommended impedance range: 20 mΩ ... 600 kΩ

*Note: Calibration (open, short, load) is required.*

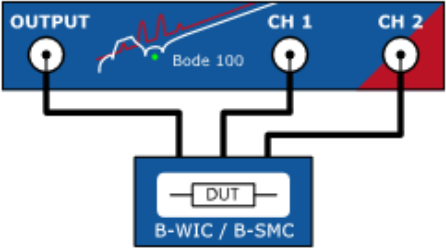

Before you can start a measurement you have to perform a **Full range calibration**. To do so please follow the steps described in [Impedance Adapter Calibration](#) on page 98.

After having performed the calibration please put the inductor you want to measure into the impedance measurement adapter as shown in 8-12 on page 62.

Since it is not known in what frequency range the examined inductor is working please change the stop frequency to 50 MHz.

Frequency	Sweep	Fixed
Start frequency	100 Hz	
Stop frequency	50 MHz	
Center	25,00005 MHz	
Span	49,9999 MHz	

Now click  in the home ribbon. As a result you will see a first measurement comparable to the one shown in the figure below. For sure your result will look different since you are using a different inductor.

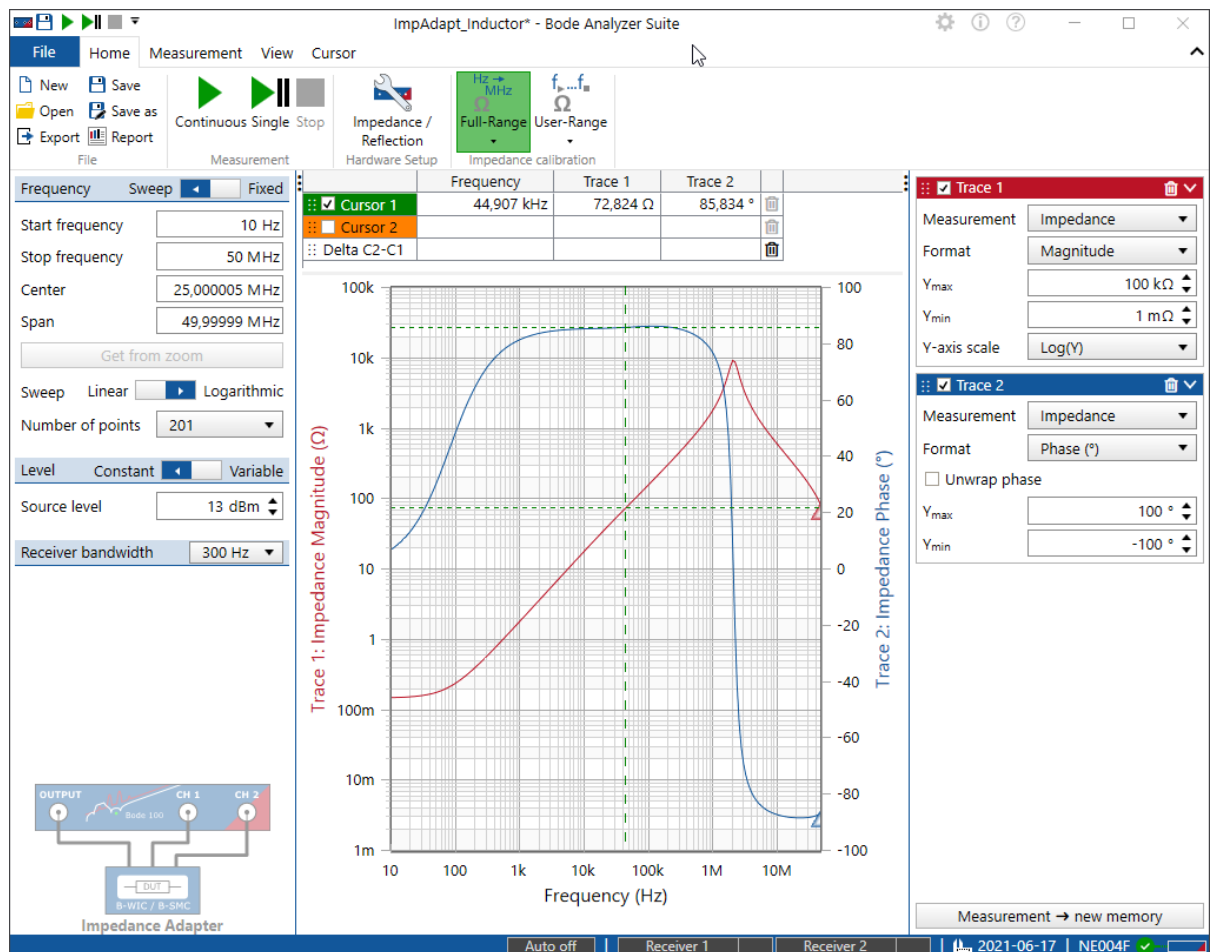
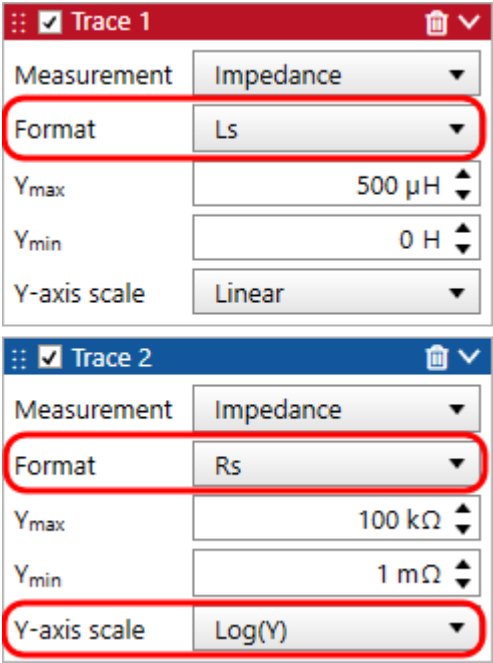

Figure 8-13: Impedance measurement of an Inductor

Trace 1 (red curve) shows the Magnitude of the inductor's impedance while Trace 2 (blue curve) shows the phase of the inductor's impedance. The magnitude curve is rising with 20 dB per decade, this indicates that we are really measuring an inductor. To measure the resistance  $R_s$  and inductance  $L_s$  of the inductor simply change the format for Trace 1 and Trace 2 as shown.



To get a better view on the  $L_s$  and  $R_s$  it is recommended to **switch to two diagrams**. To do so follow the instructions described in [11.2.1 Configure the diagrams](#) on page 117.

Well, and now we have our result:

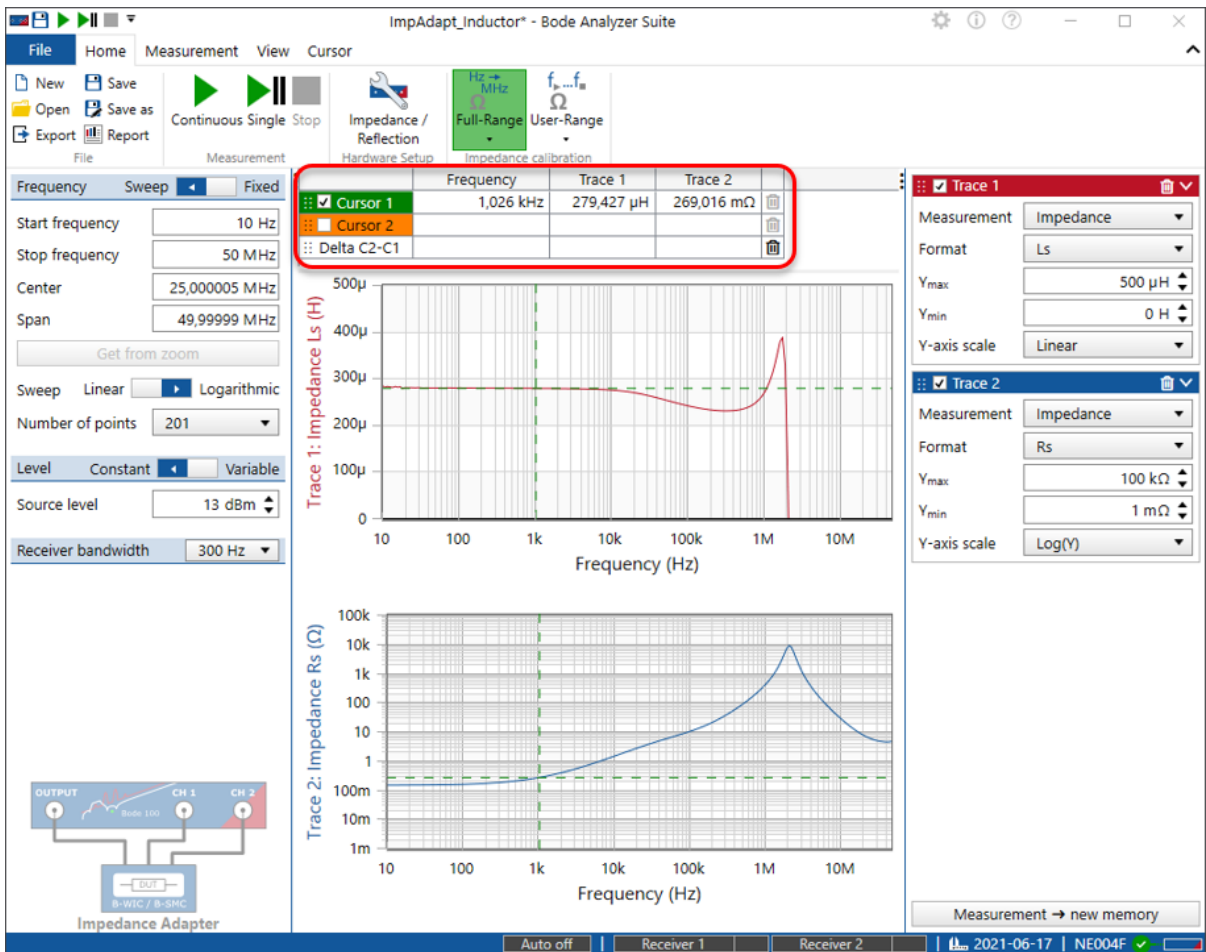



Figure 8-14: Measurement of a 280 µH inductor with the B-WIC impedance adapter

By using the cursors we can gather the following information on the measured inductor:

- The inductor has an inductance of **280 µH** up to roughly **10 kHz**
- The resistance of the inductor starts around **147 mΩ** and rises up to **10 Ω** at **100 kHz**.
- Above 10 kHz the inductance starts to drop and at roughly 2 MHz the inductor has its self-resonance frequency. Above the self-resonance frequency, the capacitive behavior dominates.

**Congratulations** you have successfully used the *B-WIC* impedance measurement adapter with the *Bode 100*. You can load the settings for the measurement by clicking File → Open → and then navigating to: "%APPDATA%\OMICRON Lab\Bode Analyzer Suite\Demo Files\". The file you will need is: **ImpAdapt\_Inductor.bode3**.

**Attention:** Since your setup will be different the file should only be used to explore the different measurement formats offered by *Bode 100*. Before you execute an own measurement you will have to **perform a new calibration**.

 For a detailed measurement example using the impedance adapter measurement mode to measure capacitors, please check out the ESR measurement application note at [www.omicron-lab.com/BodeManualAppNotes](http://www.omicron-lab.com/BodeManualAppNotes)

### 8.4.3 Shunt-Thru

The Shunt-Thru measurement mode is especially suitable to measure very small impedance values. It is basically an  $S_{21}$  transmission measurement in a special configuration. The impedance is calculated from the measured  $S_{21}$  parameter.

▼ Shunt-Thru

Measure impedance with the Shunt-Thru method.

Recommended impedance range: 1 mΩ ... 100 Ω

 Do not exceed 3.3 V<sub>rms</sub> at the output (50 Ω).  
Do not exceed 7 V<sub>rms</sub> at Channel 2 input (50 Ω).

Select measurement

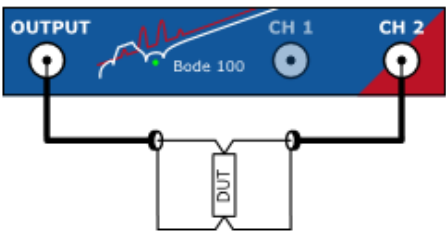

#### Measurement information

*Bode 100* measures  $S_{21}$  gain and calculates impedance  $Z$  using the equation:

$$Z = 25\Omega \frac{S_{21}}{1 - S_{21}}$$

The Shunt-Thru measurement configuration emulates a 4-wire kelvin connection. The output drives a current thru the device under test that is shunted between the output signal and GND. Channel 2 measures the voltage drop that occurs at the DUT. This measurement mode offers highest sensitivity for low-impedance value DUT. The recommended impedance measurement range starts at roughly 1 mΩ. With amplifiers or pre-amplifiers also μΩ measurements can be performed.

Shunt-Thru measurement configuration offers low sensitivity for high impedance DUTs. It is not recommended to measure impedance values much higher than 100 Ω.

- The Shunt-Thru configuration inherently suffers a ground-loop error at low frequencies. The current flowing thru the cable shield of the connection to Channel 2 ground introduces a measurement error that can become significant at frequencies below 10 kHz to 100 kHz when measuring very low impedance values. To suppress respectively reduce the ground-loop error at low frequencies, use a common-mode choke or common-mode transformer or an active isolation device. Note that the Shunt-Thru transformation from S21 to impedance assumes 50  $\Omega$  as source impedance and input impedance.

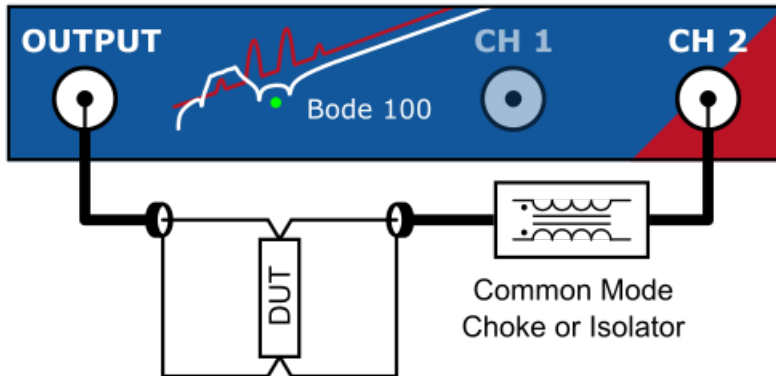

- To improve signal to noise ratio for very low impedance measurements, you can use a 50  $\Omega$  amplifier at the Output of *Bode 100* as shown in the image below. Use calibration to remove the amplifier gain and phase shift.

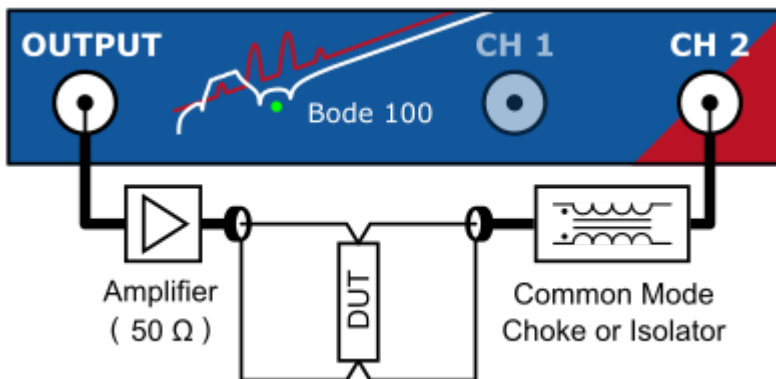

### Calibration

The Shunt-Thru measurement is basically a Gain measurement that is transformed to an impedance. Therefore **two** calibrations are possible. Either a Thru-calibration or an Open, Short, Load calibration. Thru calibration calibrates the underlying S21 measurement and removes the gain/phase shift of the cable connection, common mode choke or amplifier.

Open, Short, Load calibration shifts the reference plane directly to the calibration plane.

For more details on calibrating a Shunt-Thru measurement, please refer to [10.3.4 Calibrating a Shunt-Thru or Series-Thru measurement](#) on page 100.

## Typical applications

A typical application for the Shunt-Thru measurement mode is the ESR measurement of ultra-low ESR decoupling caps.

### 8.4.4 Shunt-Thru with series resistance

Shunt-Thru with series resistance is very similar to the normal Shunt-Thru measurement mode. For more details regarding the normal Shunt-Thru measurement mode, please see [8.2.3 Shunt-Thru](#) on page 66.

▼ Shunt-Thru with series resistance

Measure impedance with an extended version of the Shunt-Thru method. The additional series resistance shifts the recommended measurement range to higher impedance values.

Recommended impedance range:  
Rs=200 Ω: 5 mΩ ... 1125 Ω Rs=499 Ω: 11 mΩ ... 2480 Ω.

*Note: A calibration is required!*

⚠ Do not exceed 3.3 V<sub>rms</sub> at the output (50 Ω).  
Do not exceed 7 V<sub>rms</sub> at Channel 2 input (50 Ω).

Select measurement

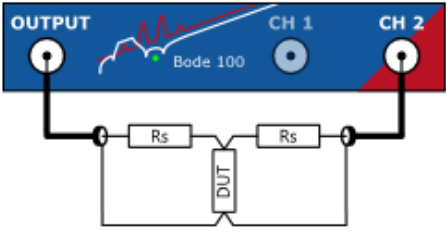

#### Measurement information

Bode 100 measures  $S_{21}$  gain and calculates impedance  $Z$  using the equation:

$$Z = \frac{50\Omega + R_s}{2} \frac{S_{21}}{1 - S_{21}}$$

Compared to the normal Shunt-Thru measurement mode, the series resistors increase the maximum measurable impedance. This is of advantage when one needs to measure from roughly 10 mΩ to some kΩs.

The higher the series Resistors  $R_s$  are chosen, the higher the maximum recommended impedance is. However, at the same time the lower impedance limit rises.



The following table shows some  $R_s$  values and their influence on the impedance measurement range:

Series Resistor $R_s$	Lower Z Limit	Upper Z Limit
200 $\Omega$	5 m $\Omega$	1125 $\Omega$
450 $\Omega$	10 m $\Omega$	2250 $\Omega$
499 $\Omega$	11 m $\Omega$	2480 $\Omega$
950 $\Omega$	20 m $\Omega$	4500 $\Omega$

 The Shunt-Thru with series resistor configuration suffers from the same systematic error as the normal Shunt-Thru configuration. Please refer to [8.2.3 Shunt-Thru](#) on page 66 for more details about the cable-braid-error.

### Calibration

The Shunt-Thru with series resistor measurement requires at least one Thru calibration. Thru calibration must be performed with the series resistors included. For more details on calibrating a Shunt-Thru measurement, please refer to [10.3.4 Calibrating a Shunt-Thru or Series-Thru measurement](#) on page 100.

## 8.4.5 Series-Thru

The Series-Thru measurement configuration is especially suitable to measure very high impedance values. It is basically an  $S_{21}$  transmission measurement in a special configuration. The impedance is calculated from the measured  $S_{21}$  parameter.

**Series-Thru**

Measure impedance with the Series-Thru method.

Recommended impedance range: 1 k $\Omega$  ... 1 M $\Omega$

 Do not exceed 3.3 V<sub>RMS</sub> at the output (50  $\Omega$ ).  
Do not exceed 7 V<sub>RMS</sub> at Channel 2 input (50  $\Omega$ ).

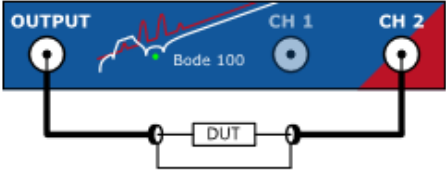

### Measurement information

Bode 100 measures  $S_{21}$  gain and calculates impedance  $Z$  using the equation:

$$Z = 100\Omega \frac{1 - S_{21}}{S_{21}}$$

The Series-Thru configuration offers high sensitivity for high-impedance DUTs. Impedance values in the M $\Omega$  region can be measured. Using an output amplifier further increases the upper impedance measurement limit.

Shunt-Thru measurement configuration is not suitable for low-impedance DUTs. It is not recommended to measure impedance values below roughly 1 k $\Omega$ .

One advantage of the series-thru connection is that a shielded test-setup can easily be constructed.

## Calibration

The Series-Thru measurement is basically a Gain measurement that is transformed to an impedance. Therefore **two** calibrations are possible. Either a Thru-calibration or an Open, Short, Load calibration. Thru calibration calibrates the underlying S21 measurement and removes the effect of the cable connection to the DUT.

Open, Short, Load calibration shifts the reference plane directly to the calibration plane.

For more details on calibrating a Series-Thru measurement, please refer to [10.3.4 Calibrating a Shunt-Thru or Series-Thru measurement](#) on page 100.

## Typical applications

A typical application for the Series-Thru measurement is the measurement of DUTs with low conductivity (high impedance).

### 8.4.6 Voltage/Current

The Voltage/Current measurement mode is basically a Gain measurement with external reference similar to the Gain/Phase measurement mode. However, the fact that the Gain is treated as an impedance result offers all impedance result formats such as L, C and Q calculations.

▼ Voltage / Current

Measure impedance by connecting a voltage probe to CH2 and a current probe to CH1.

Impedance range depends on sensitivity of the used probes.

 By default, the inputs are set to high impedance and are ac-coupled.  
Do not exceed 50 Vdc at the inputs.  
Do not exceed 3.3 Vrms at the output (50 Ω).

Select measurement

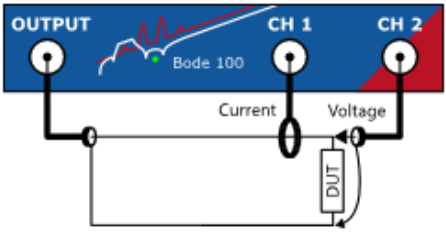

## Measurement information

*Bode 100* measures Gain and transforms it directly to impedance  $Z$  using:

$$Z = \frac{V}{I} = \frac{V_{CH2}}{V_{CH1}} = \text{Gain}$$

The voltage/current measurement is very flexible. The usable impedance measurement range cannot be generalized since it strongly depends on the used probes and connections. Using highly sensitive current sensing, very high impedance values can be measured. Using very sensitive voltage measurements, very low impedance values can be measured.

## Calibration

The Voltage/Current measurement is basically a Gain measurement that is transformed to an impedance. Therefore **two** calibrations are possible. Either a Thru-calibration or an Open, Short, Load calibration.

Thru calibration calibrates the underlying gain measurement and removes gain and phase shifts of the probes. A 1 Ω resistor is needed to perform a Thru calibration in the Voltage/Current measurement mode.

Open, Short, Load calibration shifts the reference plane directly to the calibration plane.

For more details on calibrating a Voltage/Current measurement, please refer to [10.3.5 Calibrating a Voltage/Current measurement](#) on page 102.

### Typical applications

The Voltage/Current measurement is suitable for a high variety of measurement applications. It is the mode of choice for every impedance measurement that measures voltage and current separately.

Typical measurements are:

- Input impedance measurement of active circuits such as power supplies.
- Output impedance measurement of active circuits such as power supplies.

### Measurement example

For detailed measurement examples using the voltage/current measurement mode, please check out the Non-Invasive stability application note at [www.omicron-lab.com/BodeManualAppNotes](http://www.omicron-lab.com/BodeManualAppNotes).

## 8.4.7 External Bridge

The external bridge measurement mode offers you the possibility to use an arbitrarily designed impedance measurement bridge specifically designed for your special purpose.

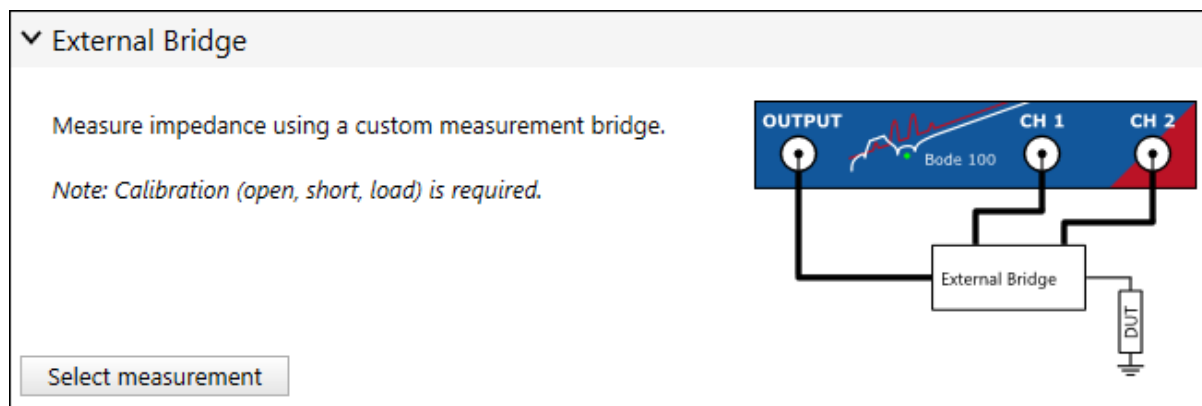

### Calibration

The external bridge measurement mode requires impedance (open, short, load) calibration. For more details on how to calibrate the an external bridge, please refer to [10.3.2 Calibrating an External Coupler or External Bridge measurement](#) on page 96.

### Measurement information

The external bridge measurement mode is similar to the Impedance Adapter measurement mode but allows you to change the channel termination and input attenuators to adjust them according to your needs.

### Measurement example

For a detailed measurement example using the external bridge measurement mode, please check out the High-impedance measurement application note at [www.omicron-lab.com/BodeManualAppNotes](http://www.omicron-lab.com/BodeManualAppNotes).

## 8.5 Advanced

### 8.5.1 SCPI server

The SCPI Server mode allows you to start a localhost SCPI server that offers you an SCPI interface to control the *Bode 100*.

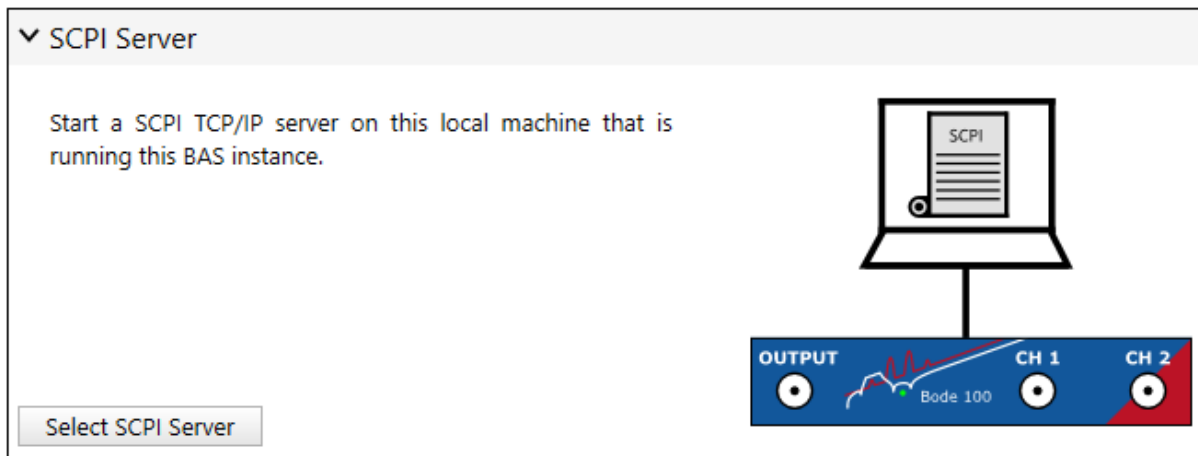

The SCPI localhost server allows you to control the *Bode 100* via SCPI commands. Please note that BAS 3.25 is a first experimental version that does not offer any GUI related features. You can only access functions that are also available via the Bode Automation Interface. This means that you can configure measurements, execute them and receive single-trace, single-channel data that you can then further process in your software application. For more information on the SCPI interface and the Bode Automation Interface, please refer to [12 Automating measurements](#) on page 154.

Server configuration

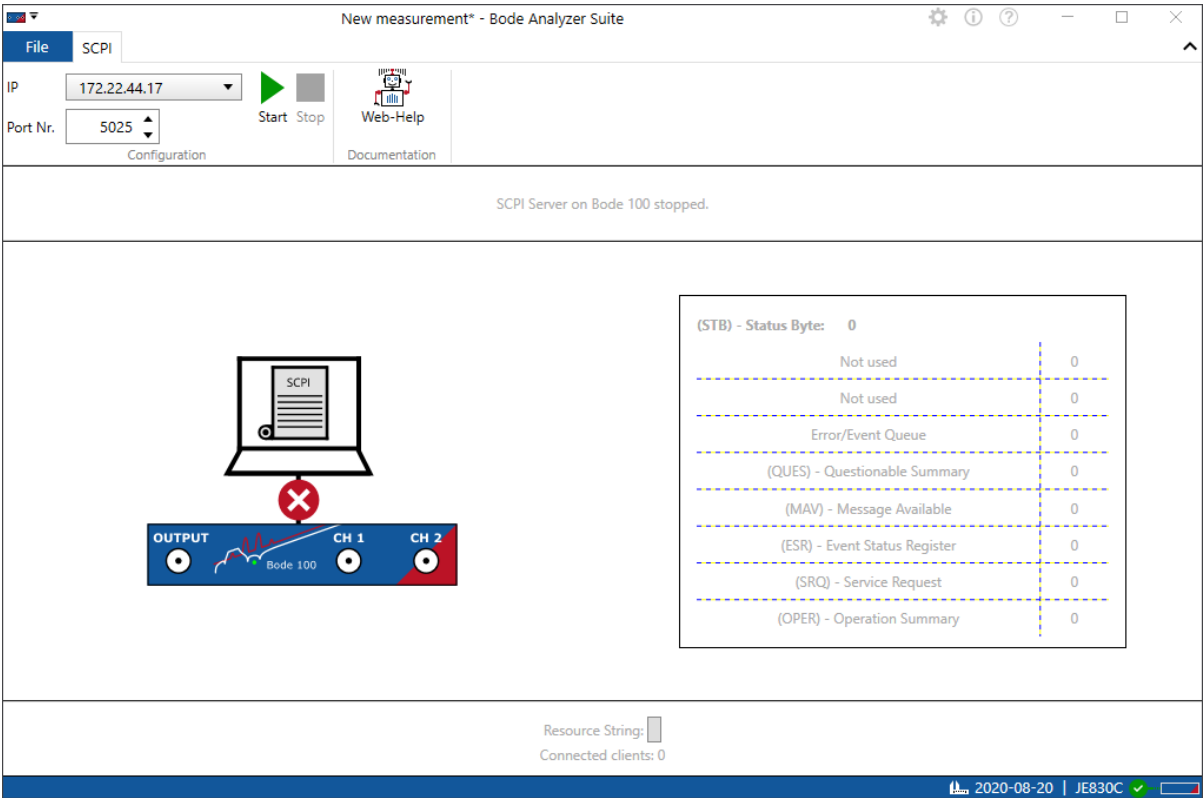

In the SPCI Server control window, you can start the server, see if it is running and configure the port-number used. Furthermore, SCPI status-byte information from the device is shown.

**i** The BAS 3.25 SCPI interface is not a remote control of the Bode Analyzer Suite. If an SCPI server is running, you cannot control the *Bode 100* via *Bode Analyzer Suite* at the same time.

# 9 Measurement and Device settings

This chapter focuses on settings and options that are required to perform good measurements. Details such as configuring the right attenuator or the correct signal source level are discussed in the following.

## 9.1 Hardware setup



By clicking on the Hardware setup icon, the hardware setup dialog is opened. The hardware setup dialog shows the internal connections of *Bode 100* as well as the external connection to the DUT. Depending on the selected measurement mode, hardware settings such as Channel termination, Receiver connection or an external Probe factor can be changed.

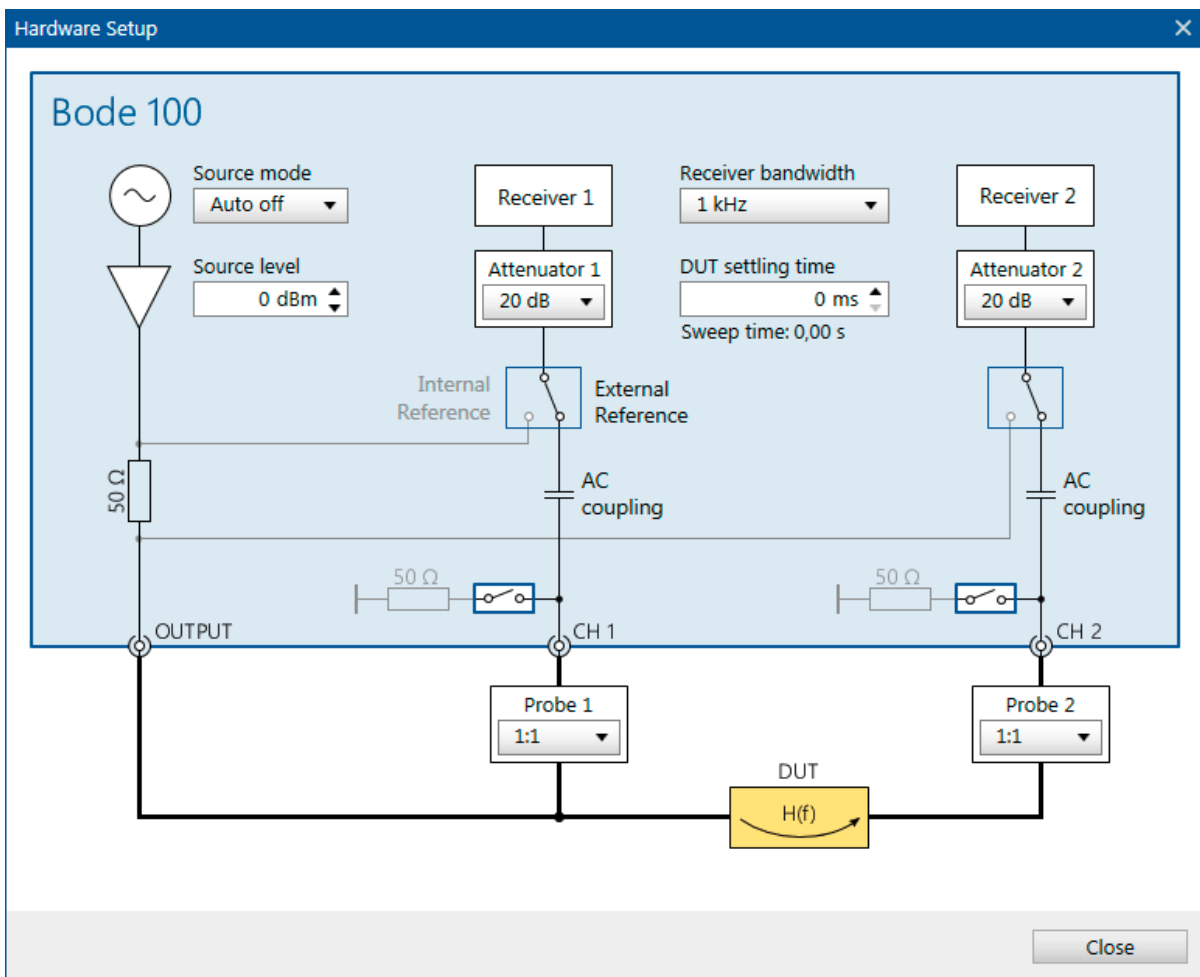

Figure 9-1: Hardware setup dialog in Gain/Phase measurement mode.

Depending on the measurement mode, some of the following settings can be changed by the user:

- **Source mode:** Choose between *Auto off* or *Always on*. More details on the source behavior of *Bode 100* can be found in [9.4 Signal source settings](#) on page 80.
- **Source level:** Set the constant source level or the reference level when the shaped level function is used.
- **Receiver bandwidth:** Select the receiver bandwidth used for the measurement.
- **DUT settling time:** Time between applying the measurement signal and starting to measure at the receiver. A DUT settling time is needed if the DUT introduces a significant time delay before the output reaches its final reaction to the input stimulus.
- **Attenuator 1 and Attenuator 2:** Select the receiver input attenuation.
- **Reference switch:** Receiver 1 and Receiver 2 can be connected either internally or externally, depending on the measurement mode.
- **Termination switch:** When switched on, the Channel 1 and Channel 2 inputs are terminated with 50  $\Omega$ . If the switch is open, the input impedance is 1 M $\Omega$ .
- **Probe 1 and Probe 2:** Some measurement modes allow you to manually enter a probe factor. For more details on using probes see [9.5 Using external probes](#) on page 83.

# 9.2 Receiver Bandwidth

A vector network analyzer (VNA) measurement is a narrow-band or frequency-selective measurement. Only one frequency of interest is analyzed at a time. To do so, the receiver is configured to be sensitive to exactly the same frequency that is currently generated by the signal generator. All other frequencies or side-bands are neglected. In reality, there is always some finite side-band content that will be included in the measurement result. The RBW setting (Receiver Bandwidth or Resolution Bandwidth) defines the width of the narrow-band filter used to generate the result. A high RBW value, will result in a fast measurement but more noise. The wider bandwidth results in more noise-energy included in the measurement and therefore in a higher noise-floor level. A low RBW value offers more noise-rejection but it will increase the measurement time.

The following picture shows the shape of the frequency-selective receiver filter for different RBW values:

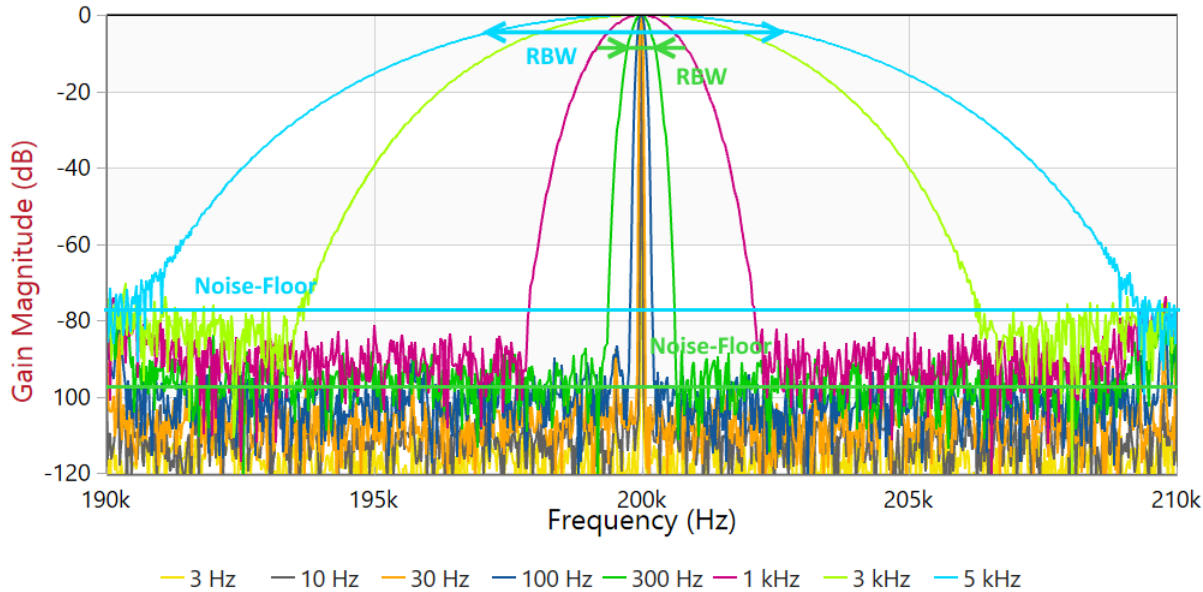

Figure 9-2: Graphical representation of the different RBW values.

**i** The Receiver Bandwidth setting in the *Bode Analyzer Suite* is actually a **maximum RBW** setting. The system will automatically reduce the RBW value when it measures at a frequency below the max. RBW value. It is impossible to measure e.g. at 10 Hz using a receiver bandwidth setting greater than 10 Hz.

Use the   setting to adjust the maximum RBW used during the measurement.



## Measurement and Device settings

Typical measurement times for a single point depending on the RBW setting are shown below:

Receiver bandwidth	Typical single-point measurement time
1 Hz	2.8 s
3 Hz	940 ms
10 Hz	280 ms
30 Hz	95 ms
100 Hz	30 ms
300 Hz	10 ms
1 kHz	3.8 ms
3 kHz	2.1 ms
5 kHz	1.7 ms

Besides the RBW setting, the receiver attenuator plays an important role to improve the signal to noise ratio (SNR).

### 9.3 Choosing the receiver attenuator

The *Bode Analyzer Suite* allows to configure the receiver attenuator of the device by selecting it in the measurement configuration on the left hand side of the main window or in the hardware setup screen.

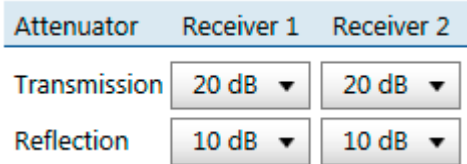

Figure 9-3: Choose the attenuator setting for Receiver 1 or Receiver 2 in the configuration area.

The receiver attenuator reduces the signal level that arrives at the receiver. This leads to a higher full-scale measurement range when using higher attenuator values. The following table shows the relation between attenuator value and full-scale input range:

Attenuator setting	<i>Bode 100</i> full-scale input measurement range
0 dB	100 mVrms
10 dB	316 mVrms
20 dB	1 Vrms
30 dB	3.16 Vrms
40 dB	10 Vrms

Depending on the signal size/level that needs to be measured, the input attenuator must be chosen.

- Try to use the lowest possible input attenuator that does not result in an **overload** warning. This will give you the best possible signal to noise ratio.

#### Receiver level indicator

The receiver level indicators in the status bar show how much signal level arrives at the receiver. Best is a level close to the full-scale but no Overload.

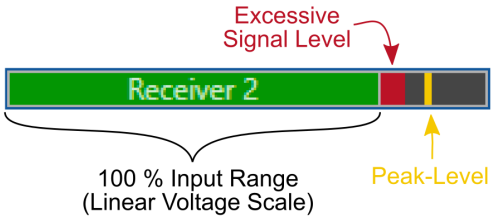

Figure 9-4: Receiver level indicator showing excessive signal causing an overload.

If an overload occurs, the measurement result will be wrong due to clipping in the receiver and the *Bode Analyzer Suite* will show a text warning in the chart as well as shaded areas where the overload did occur as shown in the image below:

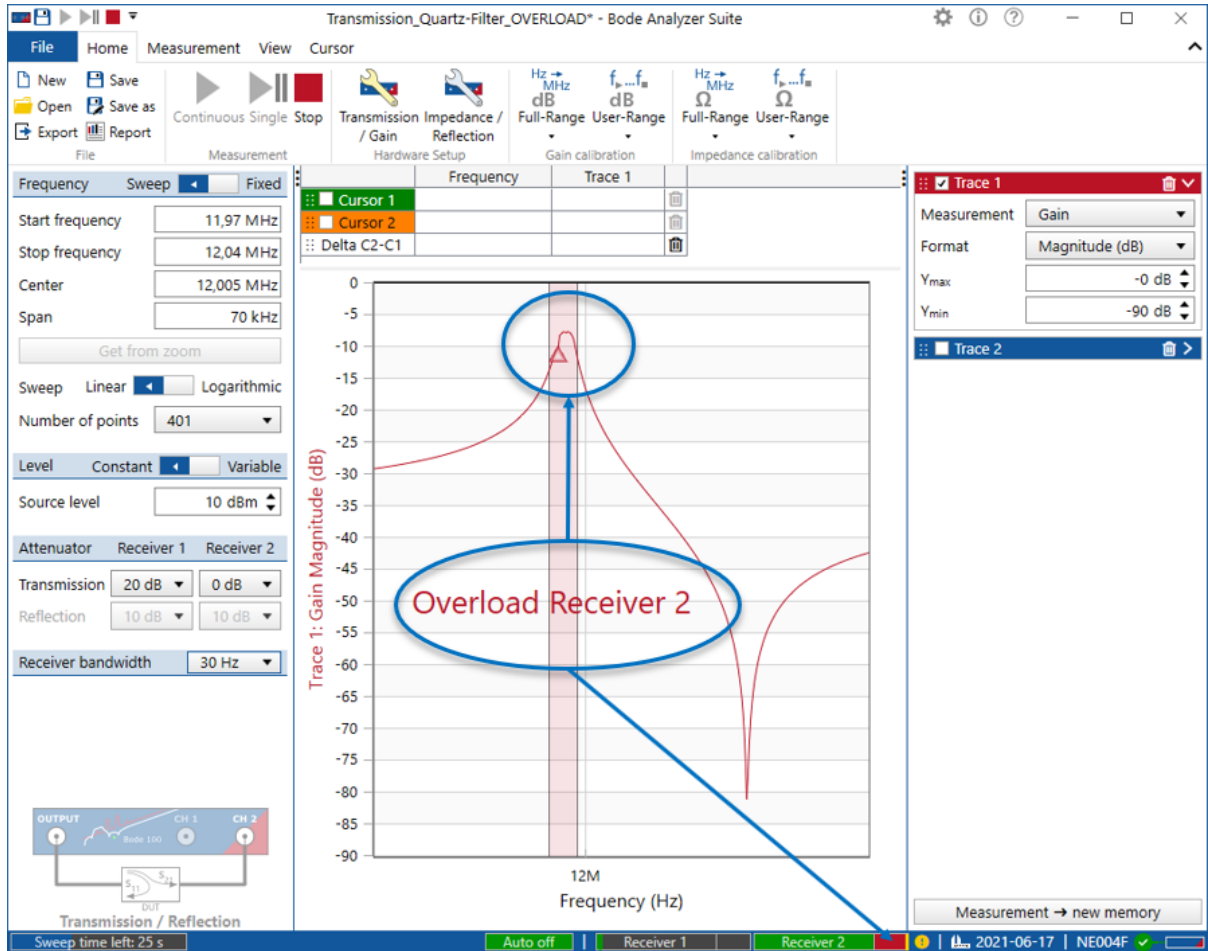

Figure 9-5: The overload at resonance is shown in the level bar in the status bar and as a text warning in the chart. The curve contains a shaded area that shows exactly at which frequencies the overload did occur.

## 9.4 Signal source settings

### Signal source mode

The signal source of *Bode 100* can be set two to different operation modes:

1. Auto off (default)
2. Always on

In **Auto off** mode, the source will be automatically turned off whenever it is not used, respectively when a measurement is stopped.

In **Always on** mode the signal source stays on after a measurement has finished. This means that e.g. the last frequency point in a sweep measurement defines the signal source frequency and level.

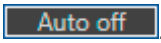
You can change the source mode either in the hardware setup  or by moving the mouse over the source indicator in the status bar .

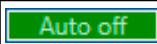
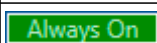
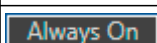

The source indicator shows both, the current setting and if the source is on or off. A gray background indicates that the source is switched off. A green background color indicates that the signal source is running. The following states are possible:

	Source mode is Auto off and source is currently off
	Source mode is Auto off and source is currently on
	Source mode is Always on and source is on
	Source mode is Always on but source is still in off-state. Source will be switched on as soon as the next measurement has been executed.

### Output level unit

*Bode 100* by default uses dBm as the output level unit. 1 dBm equals 1 mW at 50  $\Omega$  load.

-  You can also choose Vrms or Vpp as output unit however, please don't forget that the real output voltage of *Bode 100* depends on the impedance connected to the output. The inner 50  $\Omega$  source impedance of *Bode 100* introduces a voltage drop that depends on the impedance connected at the output port.

The output level unit can be changed in the options. Click on  and select the default level unit of your choice: **Default level unit:**  .

You can choose Vrms which is the root mean square of the output voltage at 50  $\Omega$  load. Again the real output voltage depends on the load you connect to the output. The internal source voltage is 2 times higher than the displayed value. Choose Vpp to display the output voltage in peak-to-peak voltage. Again, the value is valid when a 50  $\Omega$  load connected to the output.

-  Changing the level unit only affects new files / measurements that are created after changing the unit. The level unit is part of the settings stored in the .bode3 file.

## Shaped level

The shaped level feature of *Bode 100* allows changing the output level over frequency.

To use the shaped level feature, click on the slider selector to switch between constant and variable

level  Level  Constant  Variable

After switching to variable, the Output level text field changes its name to Reference level and the Shape level button appears:

Click on the Shape level button to enter the shaped level dialog shown in the figure below:

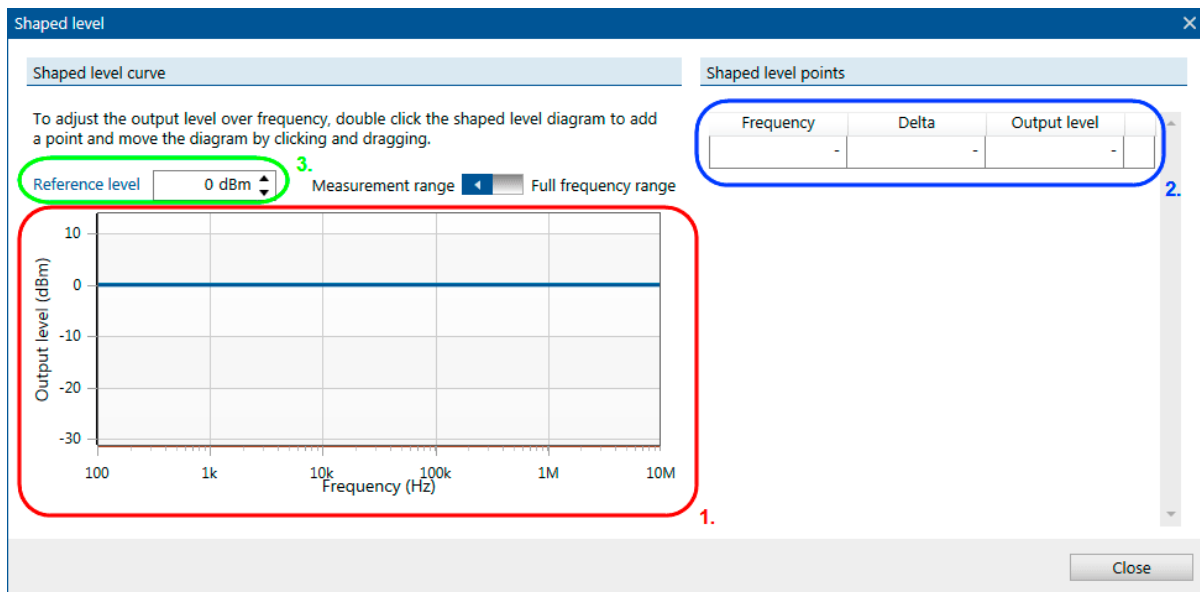

Figure 9-6: Shaped level dialog

In the shaped level dialog you can perform the following actions:

1. **Interactive shaped level diagram**  
Shows the shaped level curve. Use your mouse to enter new shaped level points by double-clicking or right-clicking into the diagram. Shaped level points can be moved by drag-and-drop in the diagram. The blue line in the diagram shows the reference level line which allows you to shift the entire shaped level curve up and down.
2. **Shaped level points table**  
The table contains all shaped level points. Points added via mouse click into the diagram will show up in the table. You can also use the table to enter new points manually.
3. **Reference level**  
The reference level allows you to shift the entire shaped level curve up and down by either entering a different reference level value or by moving the blue reference level line in the diagram.

The output level is calculated by the equation:

$$\text{Output level} = \text{Reference level} + \text{Delta}$$

When changing the reference level it might happen that the calculated Output level is higher than the maximum output level of *Bode 100* or lower than the minimum output level of *Bode 100*. In such a case the level is automatically limited to the device limits.

This is indicated by an orange limit line and an orange cell color in the shaped level dialog as shown in the following figure:

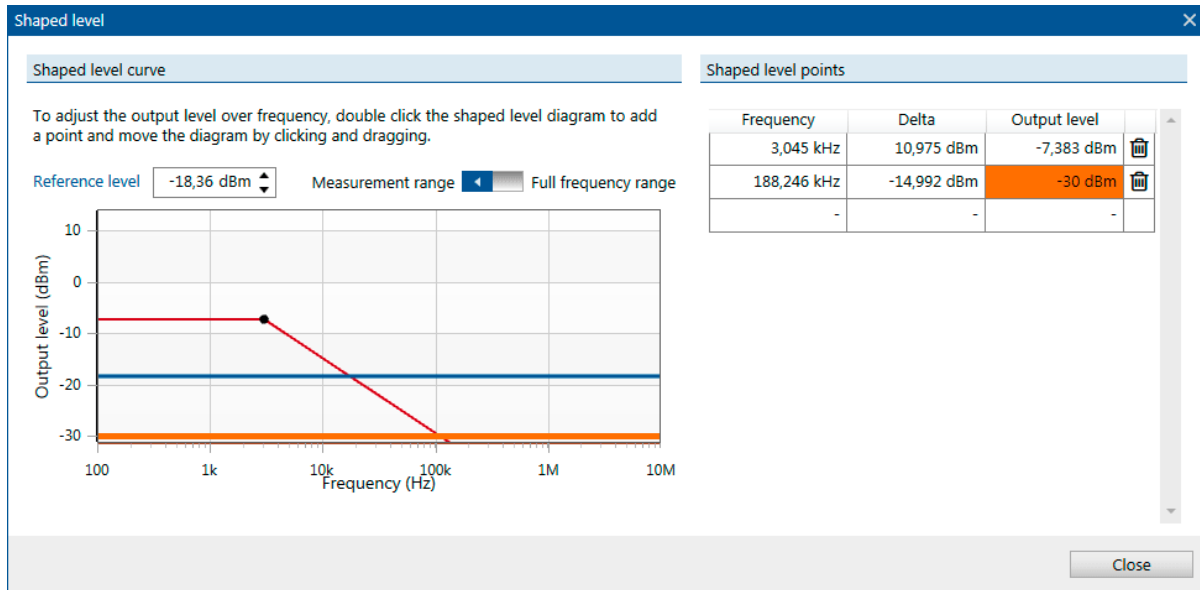

Figure 9-7: Output level limited to the minimum output level of the device

## 9.5 Using external probes

You can use any probe with *Bode 100* that offers a standard BNC connector. The use of probes can have the following advantages:

- Reduction of the capacitive loading added by connecting *Bode 100* to your circuit.
- Easier probing possibilities when no BNC connectors are available on the DUT.
- Protection of *Bode 100* from hazardous voltages if **isolating probes** are used.

### WARNING



#### Death or severe injury due to hazardous voltage levels possible.

*Bode 100* is a SELV device and the housing is not connected to safety ground via the power supply.

- ▶ Ensure that voltage and current probes used with *Bode 100* are properly grounded in accordance with their manufacturer's guidelines.
- ▶ When working with voltage or current probes, always connect the *Bode 100*'s ground terminal (available for HW Rev. 2 or higher) with a solid connection of at least 3.6 mm<sup>2</sup> cross-section and not longer than 10 m to the ground terminal in the laboratory.

### NOTICE

#### Risk of permanent damage of the device.

The inputs of *Bode 100* inputs are AC coupled with a maximum allowed DC voltage of 50 VDC. A standard, passive, 10:1 probe with 9 M $\Omega$  tip-resistor will not divide the DC voltage.

- ▶ Use suitable probes when measuring on DC levels above 50 V
- ▶ Do not use standard 10:1 oscilloscope probes with the *Bode 100*



1 M $\Omega$  10:1 probes are recommended. 1 M $\Omega$  probes feature a divider in the probe that lowers DC voltage as well. Furthermore 1 M $\Omega$  probes provide a lower impedance path that reduces channel-channel crosstalk and noise. OMICRON Lab recommends using the PML-1110 probe from PMK for the use with *Bode 100*.

#### Probe factor

If a probe has a different probe factor than 1:1, you can configure the probe factor in the hardware setup dialog for each channel separately. To do so, enter the hardware setup dialog by clicking on the

hardware setup icon in the home ribbon



The following figure shows the hardware setup dialog for a Gain / Phase measurement where two external probes (Probe 1 and Probe 2) can be configured.

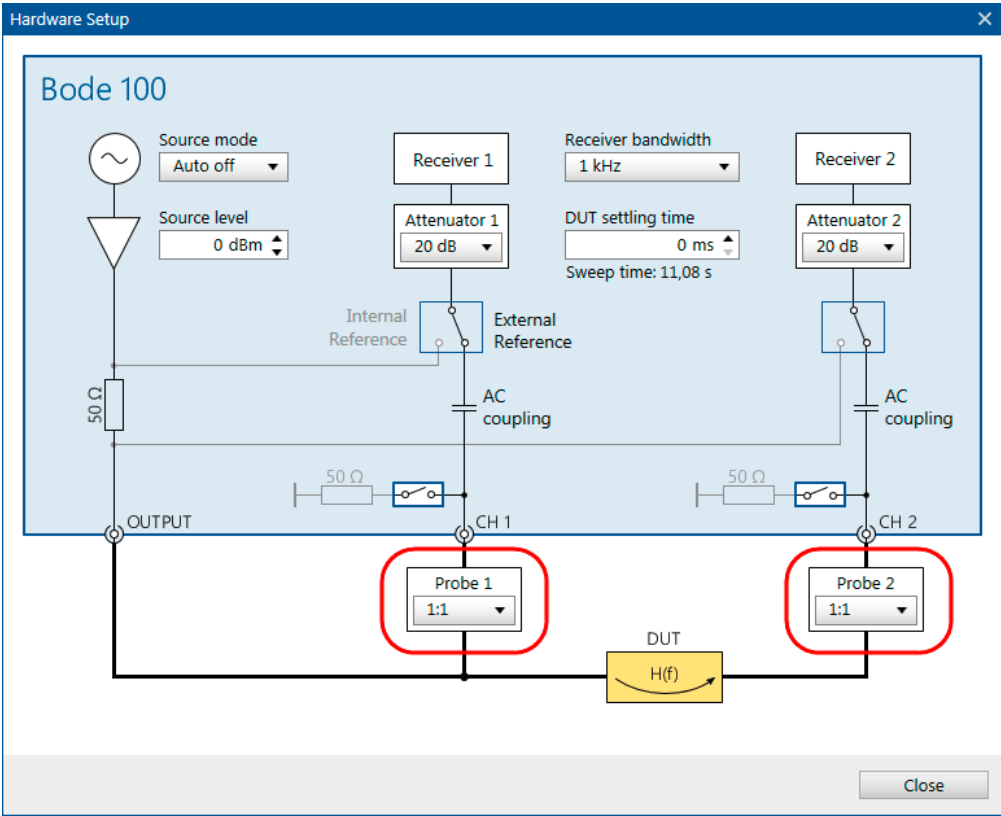
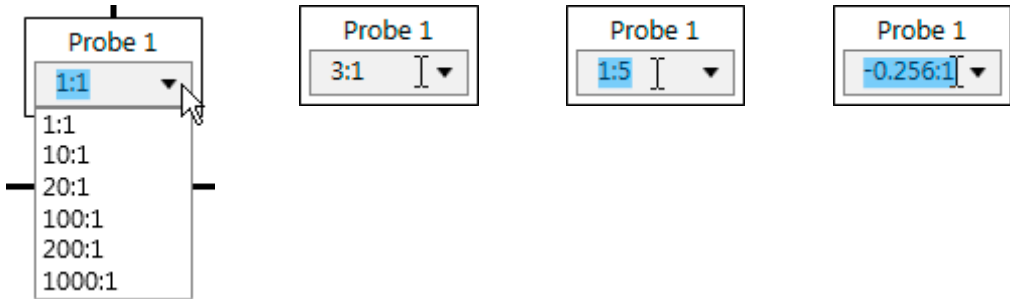

Figure 9-8: Probe configuration in the hardware setup dialog

To configure the probe factor, you can use the combo-box. Click on the arrow and select one of the pre-defined probe factors. Alternatively you can enter an **arbitrary** probe factor by marking the text and entering your probe ratio as shown in the examples below:



**i** The probe factor is directly influencing the measurement result. However, as soon as you perform a User-Range calibration or a Full-Range calibration, the probe factor has no direct effect on the measurement result anymore. An external calibration compensates the gain and phase response of the probes and therefore overrides the probe factor setting.



## 10 Calibration / Correction

This section explains how to compensate unwanted effects of the measurement setup and how to improve the accuracy of your measurement results. *Bode 100* offers the following possibilities to calibrate a test setup or the device itself:

### Factory calibration / adjustment

*Bode 100* can be adjusted / re-calibrated at OMICRON. For details regarding this factory calibration, please contact the OMICRON Lab [support](#) or your local OMICRON Lab contact.

### Internal device calibration

In addition to the external software calibration *Bode 100* features an internal device calibration that compensates the device-internal signal path drift by performing internal measurements.

### External calibration / correction

External calibration can be used to compensate e.g. the frequency response of probes, cables or the test setup. Depending on the used measurement mode *Bode 100* offers [Gain calibration](#) as well as [Impedance calibration](#).



**Hint:** To achieve maximum accuracy, **do not change** the attenuators **after** having performed an external calibration.

## 10.1 Internal device calibration

Internal device calibration is required by the system and is automatically performed at the first use of a *Bode 100* on a computer. *Bode 100* performs an internal path compensation based on stable reference elements in the device. The correction data is evaluated and stored on the PC for future measurements. In the *Bode Analyzer Suite* the date of the last internal device calibration is shown in the status bar  2017-02-20.



It is recommended to re-perform the internal device calibration on a regular basis to improve measurement accuracy especially when no external calibration is performed. Furthermore it is necessary to start a new internal device calibration whenever the environmental conditions, such as temperature, change.

### Manually starting a new internal device calibration

To perform a new internal device calibration, move the mouse over the calibration indicator in the status bar  2017-02-20. A pop-up with a button appears:

Date of the last internal device calibration: 2016-11-28 09:24

[Click here to perform a new internal device calibration](#)

Press the button **Click here to perform a new internal device calibration** and the device will start a new internal calibration. The calibration takes roughly 1 min. During the calibration you cannot perform any measurements with *Bode 100*.

## 10.2 Performing a Gain Calibration

Gain calibration (also called Thru calibration) is used to remove the gain and phase error introduced by the connections between the measurement instrument and the DUT in a gain or transmission measurement.

 To achieve maximum accuracy, **do not change** the attenuators **after** having performed an external calibration.

 Thru calibration can also be used in impedance measurements that are based on a gain measurement. These measurement modes are e.g. Shunt-Thru, Series-Thru or Voltage/Current. When performing a Thru calibration in such a mode, the underlying gain measurement is calibrated and afterwards the calibrated gain result is transformed to impedance.

### Performing the calibration

In order to calibrate a gain measurement, please proceed as follows:

1. Build up the calibration setup. For details on the calibration setup, please see [10.2.1 Calibrating a Transmission \(S21\) measurement](#) on page 88 or [10.2.2 Calibrating a Gain/Phase measurement](#) on page 89.
2. In the *Bode Analyzer Suite*, click on the Gain calibration icon (either User-Range or Full-Range). To learn more about the difference between User-Range and Full-Range calibration please check [10.3.1 Difference between Full-Range and User-Range calibration](#) on page 103.

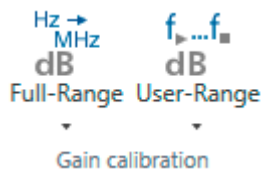

3. The calibration dialog opens and the calibration state shows **Not Performed**.



4. Ensure that the calibration setup is connected properly and press **Start**.



5. Wait until the calibration has completed and the calibration state shows **Performed**.



6. Close the calibration dialog.

7. The calibration icon now shows a green background fill.



This means calibration is activated.

8. You can now connect your DUT and perform a calibrated measurement.

## 10.2.1 Calibrating a Transmission (S21) measurement

This section shows how to calibrate a Gain, Transmission or S21 measurement performed in the **Transmission / Reflection measurement mode**.

-  The Transmission / Reflection mode offers the possibility to measure Transmission and Reflection sequentially.  
**Note:** The gain or Thru calibration is only applied to the gain measurement. If you want to calibrate the Impedance, Reflection or Admittance measurement, refer to [10.3.1 Calibrating a Reflection or One-Port measurement](#) (see page 94).

In the Transmission / Reflection measurement mode Channel 1 is not in use by default. Receiver 1 is connected internally to the signal source through the internal reference. The Channel 2 termination is set to 50  $\Omega$ , therefore by default the Gain result equals the transmission S-parameter S21 from the OUTPUT port to the CH2 port. If you choose to measure with the External reference connection, please refer to [10.2.2 Calibrating a Gain/Phase measurement](#) on page 89.

The following picture shows a typical transmission calibration setup. The DUT is replaced by a Thru-connector.

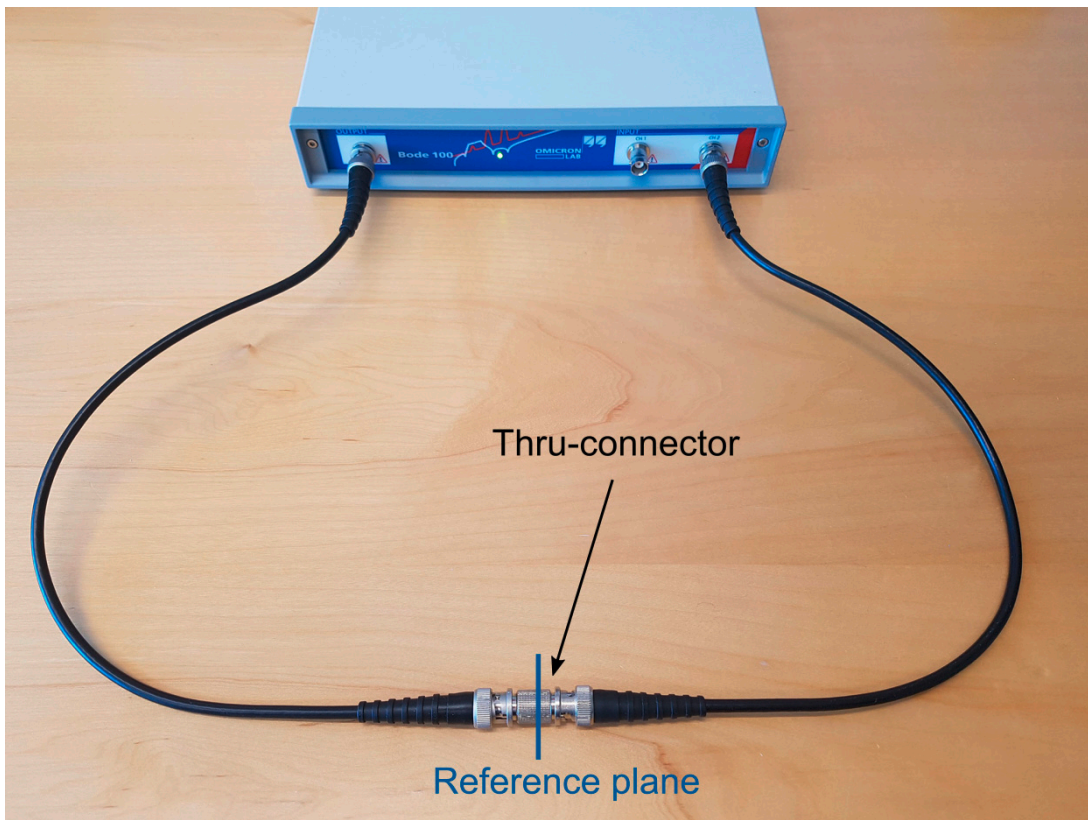



Figure 10-1: Gain, respectively Thru calibration setup in a transmission measurement.

-  The factory calibration of *Bode 100* moves the reference plane exactly between two cables of 0.5 m length. So you can measure S21 using the delivered cables having a well calibrated test-setup.

## 10.2.2 Calibrating a Gain/Phase measurement

In this section you learn how to calibrate a gain measurement in the **Gain/Phase measurement mode**.

The Gain/Phase measurement mode uses Channel 1 and Channel 2 of *Bode 100* to measure the transfer function of a DUT. Channel 1 must be connected to the input of the DUT and Channel 2 to the output of the DUT. The transfer function of the DUT (complex gain) is then measured by dividing the voltage at Channel 2 by the voltage at Channel 1.

The cables or probes that connect Channel 1 and Channel 2 to the DUT introduce a gain and phase shift to the measurement signal.

The connection introduces a measurement error if the gain and phase shift of the two probes or cables is not identical.

A gain respectively Thru calibration removes the gain and phase error that is caused by non-similar probes or connections.

The following pictures show a typical gain calibration setup with BNC cables. Both channels are connected to the same signal.

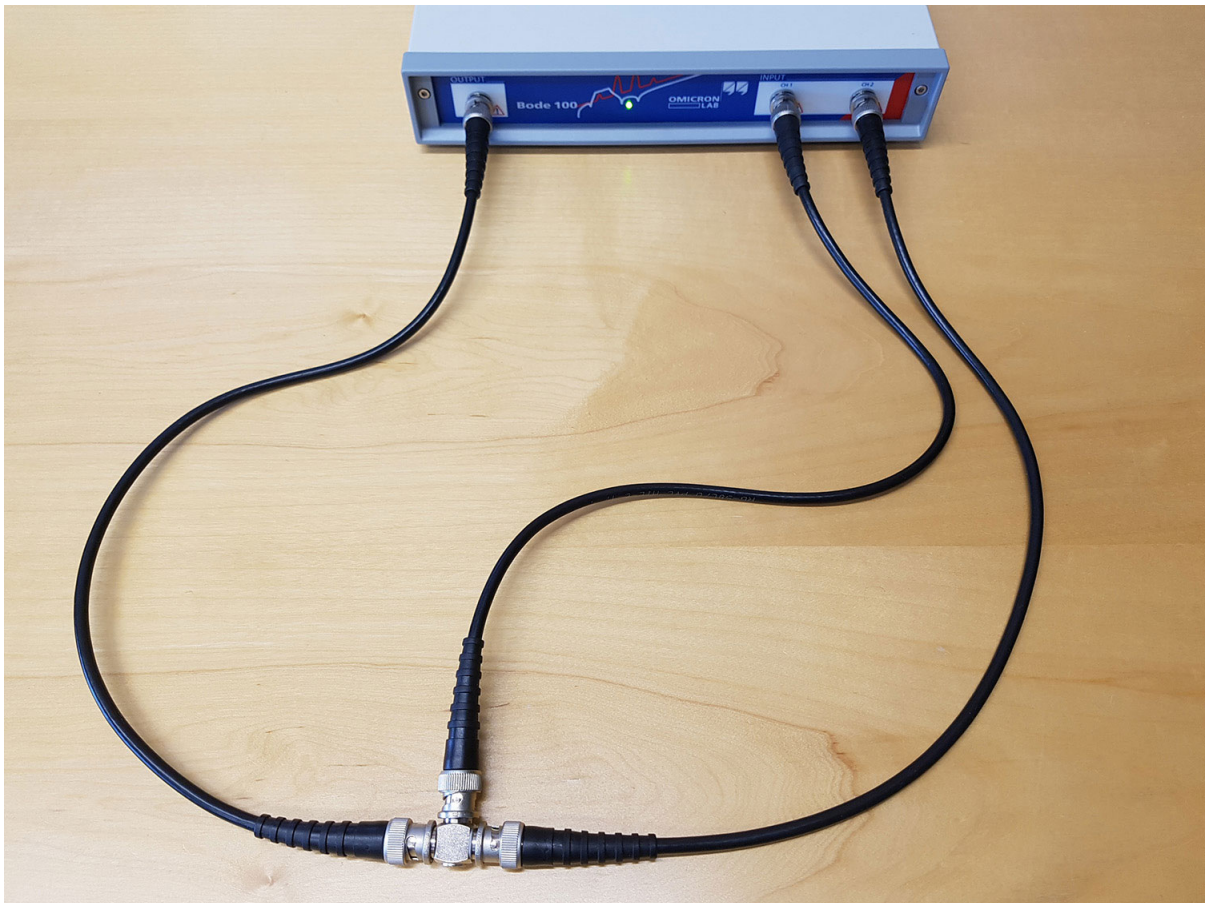

Figure 10-2: Thru calibration setup for gain/phase measurement with BNC cables.



The following picture shows a typical gain calibration setup using external voltage probes. Both probes must be connected to the same signal during Thru calibration.

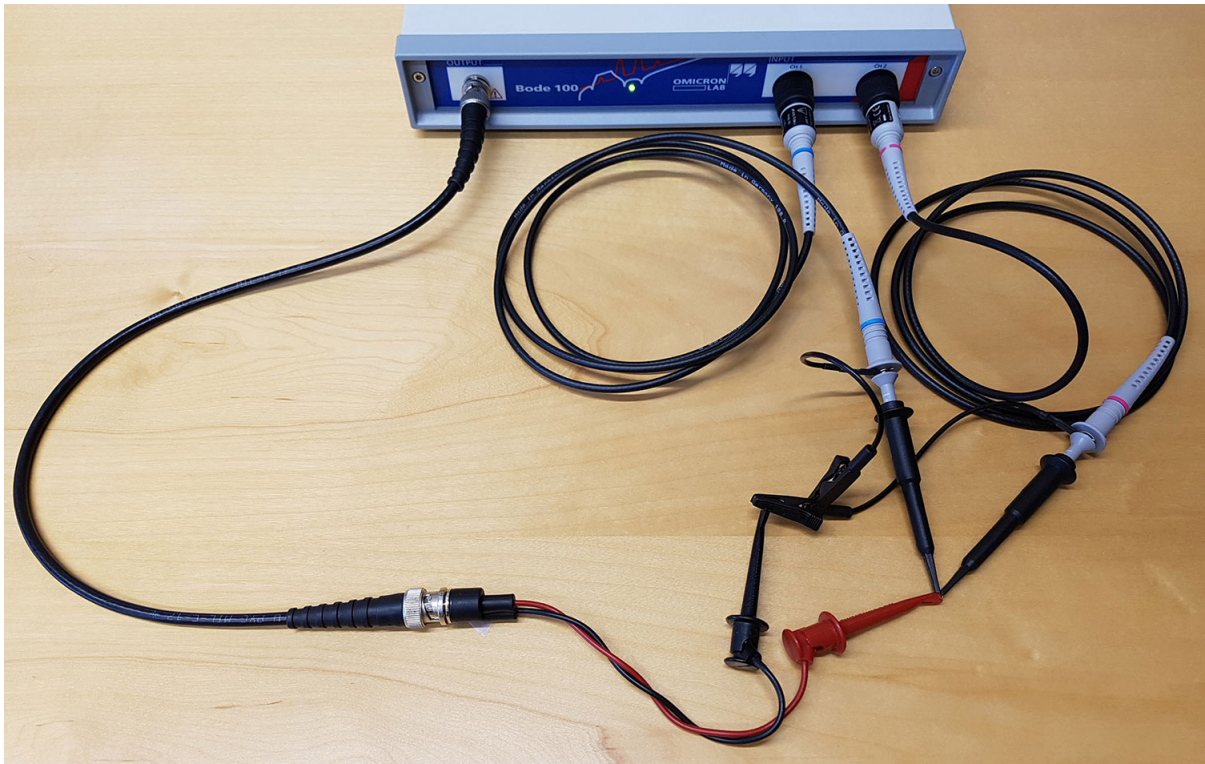



Figure 10-3: Thru calibration setup for gain/phase measurement using scope probes.

- i** **Hint:** If you use external scope probes, you can also adjust the probes manually using the compensation screw at the probe tip. To do so, perform a continuous gain/phase sweep over the frequency range of interest and adjust the probe compensation until you receive a flat 0 dB and 0 ° line. Mark the probes with Channel 1 and Channel 2 such that you can re-use the similarly adjusted probes.
- i** **Hint:** When measuring a transfer function directly in a circuit you can always check your calibration by connecting both probes to the same point in the circuit. The result must show 0 dB and 0 °. Please note that this measurement might be influenced by additional noise from the circuit.

## 10.3 Performing an Impedance Calibration

Impedance calibration (also called Open/Short/Load calibration or OSL calibration) can be used to compensate the parasitics of a measurement setup such as an external directional coupler or a measurement bridge. Furthermore it can be used to shift the reference plane of a one-port reflection measurement from the *Bode 100* output port to the end of a cable of arbitrary length. This is achieved by measuring known Open, Short and Load elements.

 To achieve maximum accuracy, **do not change** the attenuators **after** having performed an external calibration.

### Performing a Open/Short/Load calibration

In order to perform an Open/Short/Load calibration please proceed as follows:

1. Build up the calibration setup. For details on the correct calibration setup, please check the following chapters.
2. In the *Bode Analyzer Suite*, click on an Impedance calibration icon (either User-Range or Full-Range). To learn more about the difference between Full-Range and User-Range calibration please see [10.3.1 Difference between Full-Range and User-Range calibration](#) on page 103.



3. In the calibration dialog, the calibration state shows **Not Performed** for all three calibration points.

Open	Start	Not Performed
Short	Start	Not Performed
Load	Start	Not Performed

Connect the Open calibrator and press **Start**.

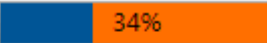
Open	Cancel	 34%
Short	Start	Not Performed
Load	Start	Not Performed

Wait until the Open calibration has completed and the calibration state shows **Performed**.

Open	Start	Performed
Short	Start	Not Performed
Load	Start	Not Performed

4. Connect the Short calibrator and press Start.
5. Connect the Load calibrator and press Start.

6. Close the calibration dialog after Open, Short and Load have been performed.

Open	<input type="button" value="Start"/>	<input type="button" value="Performed"/>
Short	<input type="button" value="Start"/>	<input type="button" value="Performed"/>
Load	<input type="button" value="Start"/>	<input type="button" value="Performed"/>

7. The calibration icon now shows a green background fill.



This means that the calibration is active now. You can connect your DUT and perform a calibrated measurement.

### Advanced Settings in Open/Short/Load calibration

The calibration dialog offers an Advanced Settings region that can be unfolded by clicking on the arrow .

**Full Range Calibration** [X]

**Impedance calibration:**

Connect the corresponding calibration object to the measurement port. Then press Start to perform the calibration. Note: All three calibrations (Open, Short, Load) must be performed.

Open	<input type="button" value="Start"/>	<input type="button" value="Not Performed"/>
Short	<input type="button" value="Start"/>	<input type="button" value="Not Performed"/>
Load	<input type="button" value="Start"/>	<input type="button" value="Not Performed"/>

▼ Advanced Settings

Load Resistor  Ω

Short Delay Time  ps



In the Advanced Settings region you can change the following values:

1. The Load Resistor value represents the value of the resistor used for Load calibration.
2. Short Delay Time is the time delay of the Short element used for Short calibration.

- The default settings for Load Resistor and Short Delay Time depend on the measurement mode.
- If you change a value from its default a warning sign will be shown  
> Advanced Settings 
- Changing Load Resistor or Short Delay Time will delete the corresponding calibration!

### Short Delay Time

The shorting cap used for Short calibration is not an ideal short but adds an additional time-delay to the signal. This time-delay adds an additional phase shift to the measured reflection coefficient at short

$$\Gamma_S = -e^{-j\omega T_s}$$

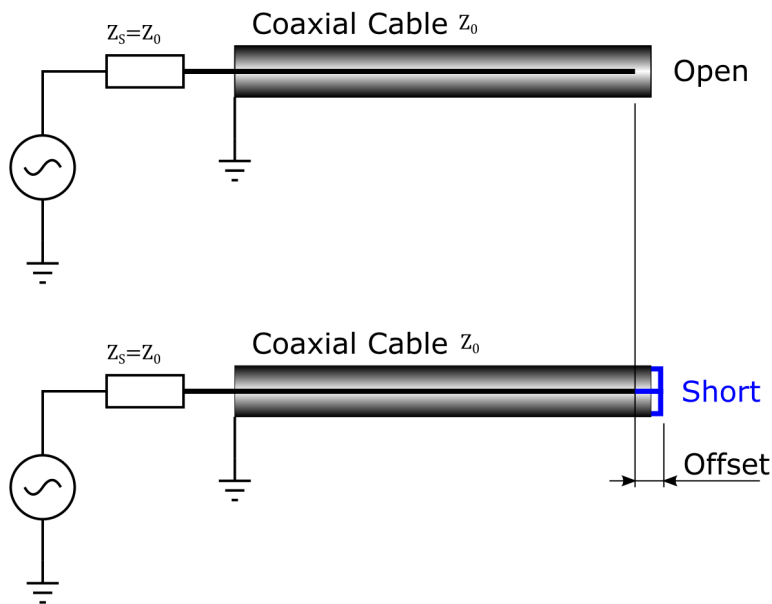

For small values of  $T_s$ , the short delay time can be translated into an equivalent inductance of

$$L \approx 25 \cdot T_s$$

Take care when measuring small inductance values in the nH range. The short-delay time or parasitic inductance of the short will have a strong impact on a low-inductance respectively a low impedance measurement.

### 10.3.1 Calibrating a Reflection or One-Port Impedance measurement

In this section you learn how to calibrate an Impedance, Reflection or Admittance measurement in the **Transmission / Reflection measurement mode** or in the **One-Port impedance measurement mode**.

The Transmission / Reflection mode offers the possibility to measure Transmission and Reflection sequentially. Please note that the Impedance (Open/Short/Load) calibration is only applied to a Impedance, Reflection or Admittance measurement. If you want to calibrate a Gain measurement please refer to [10.2.1 Calibrating a Transmission \(S21\) measurement](#) (see page 88).

In the **Transmission / Reflection measurement mode** or in the **One-Port impedance measurement mode** both receivers are internally connected to the 50  $\Omega$  source resistance. *Bode 100* is internally calibrated such that it measures the Impedance/Reflection directly at the OUTPUT port of the device. The reference plane is directly at the OUTPUT port (BNC connector).

When connecting a DUT with a coaxial cable, the cable introduces additional impedance and time-delay. To compensate these effects, the reference plane can be moved to the end of the cable by performing an Open/Short/Load calibration at the end of the cable.

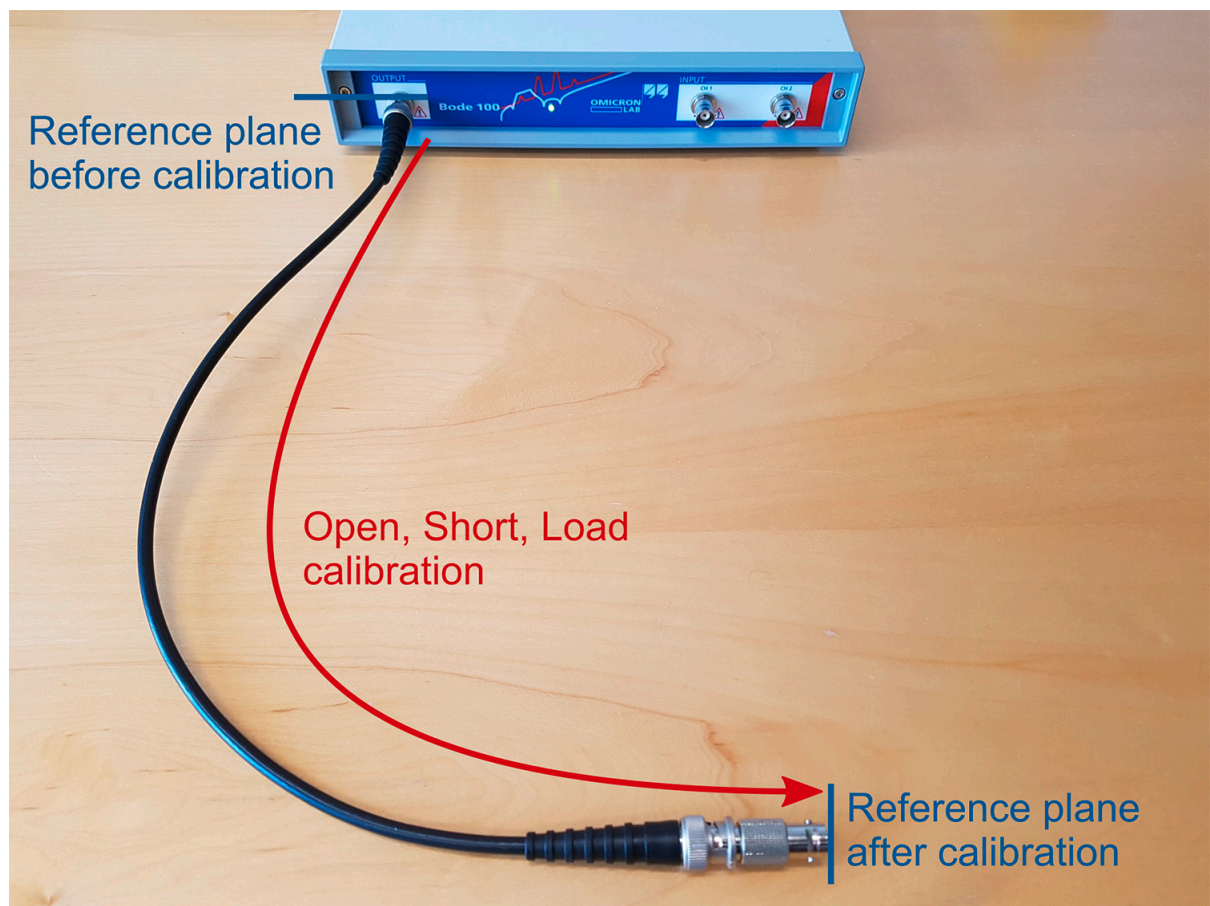

Figure 10-4: Shifting the reference plane by performing Open, Short and Load Calibration

To do so, perform Open, Short and Load calibration as shown in the pictures below:



Connect Open and press **Start**.

Wait until the Open calibration has performed.



Check if your Short element fits to the Short Delay Time Setting (50 ps default).

Connect Short and press **Start**.

Wait until the Short calibration has performed.



Check if your Load element fits the Load Resistance Setting (50  $\Omega$  default).

Connect Load and press **Start**.

Wait until the Load calibration has performed.



**Hint:** The load delivered with the Bode 100 is marked with its exact impedance. You can improve the calibration accuracy by entering this value in the Advanced Settings area. The Short Delay Time in the Advanced Settings area has been chosen to match the Short elements delivered with *Bode 100*. If your short is marked with *Rosenberger* you can set the Short Delay Time to 40 ps, if it is marked with *Radiall* to 60 ps.

### 10.3.2 Calibrating an External Coupler or External Bridge measurement

In this section you learn how to calibrate an Impedance, Reflection or Admittance measurement in the **External Coupler measurement mode** or in the **External Bridge impedance measurement mode**.

In the **External Coupler measurement mode** and the **External Bridge impedance measurement mode** both receivers are connected to the input Channel 1 and Channel 2. Therefore all three ports of *Bode 100* must be used in these measurement modes.

A directional coupler or a resistive measurement bridge is never ideal and therefore introduces errors caused by e.g. the frequency response of the coupler or bridge. By using Open, Short and Load calibration, a Reference plane at the output of the coupler or bridge can be established such that all frequency dependencies of the coupler or bridge are compensated. In the following example we show how to remove an external measurement bridge by performing Open, Short and Load calibration at the measurement port of the bridge. The same method can be applied to a directional coupler having forward and reflected ports.

-  The External Coupler measurement mode as well as the External Bridge measurement mode require an impedance calibration. You cannot start a measurement without having performed Open, Short and Load calibration.

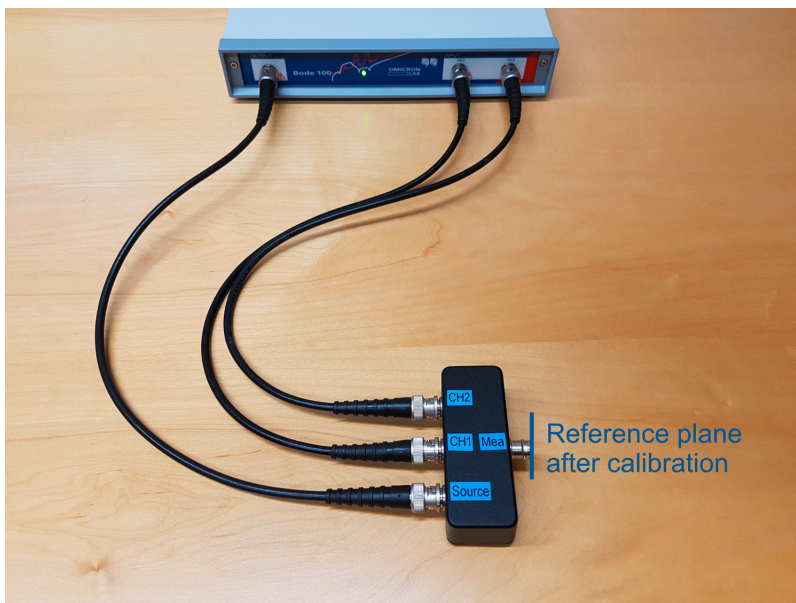

Figure 10-5: Removing a coupler / bridge by performing Open, Short and Load Calibration



## Calibration / Correction



Connect Open and press **Start** .

Wait until the Open calibration has performed.

Open



Check if your Short element fits to the Short Delay Time Setting (50 ps default).

Connect Short and press **Start**.

Wait until the Short calibration has performed.

Short



Check if your Load element fits the Load Resistance Setting (50  $\Omega$  default).

Connect Load and press **Start**.

Wait until the Load calibration has performed.

Load

### 10.3.3 Calibrating an Impedance Adapter measurement

In this section you learn how to calibrate an Impedance, Reflection or Admittance measurement in the **Impedance Adapter measurement mode**.

In the **External Coupler measurement mode** and the **External Bridge impedance measurement mode** both receivers are connected to the input Channel 1 and Channel 2 at the front panel of *Bode 100*.

The Impedance Adapter measurement mode is designed for component impedance measurements performed with the *B-WIC* and *B-SMC* impedance test-fixtures from OMICRON Lab. *B-WIC* and *B-SMC* contain a resistive measurement bridge, which is specifically optimized for *Bode 100*.

-  The Impedance Adapter measurement mode requires impedance calibration. You cannot start a measurement without having Open, Short and Load calibration performed.



Figure 10-6: Calibrating the B-WIC impedance test fixture by performing Open, Short and Load Calibration



The following pictures show how to perform Open, Short and Load calibration steps for the *B-WIC* and *B-SMC* impedance test fixtures. Note that in the Impedance Adapter measurement mode the default value for Load Resistor is 100  $\Omega$  and the default value for Short Delay Time is 0 ps.

Open (B-WIC)



Open (B-SMC)

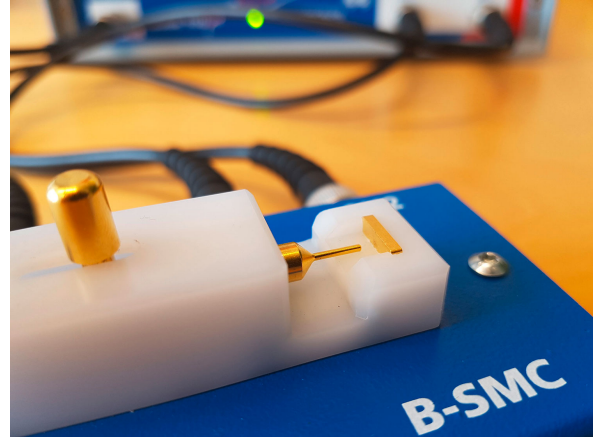

Short (B-WIC)



Short (B-SMC)

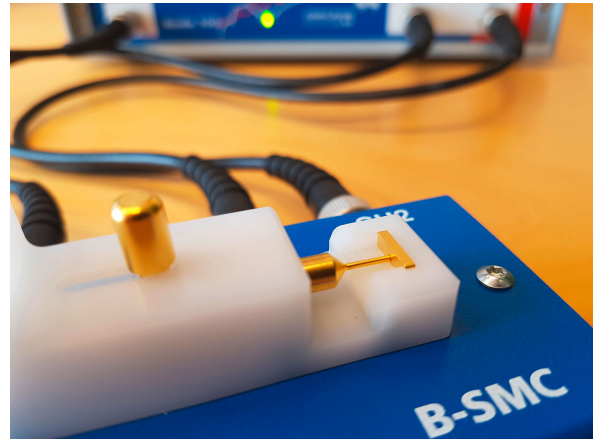

Load (B-WIC)



Load (B-SMC)

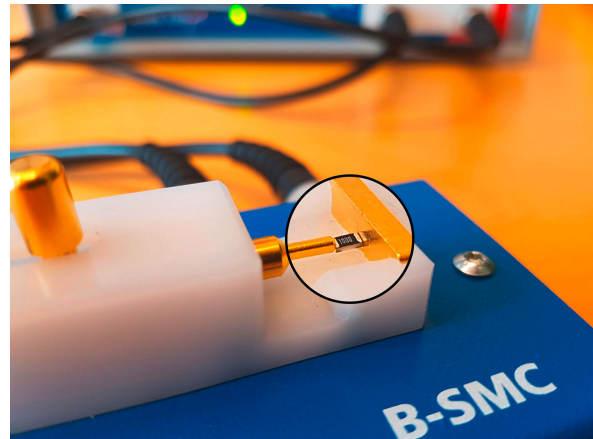



### 10.3.4 Calibrating a Shunt-Thru or Series-Thru measurement

In this section you learn how to calibrate an Impedance, Reflection or Admittance measurement in the **Shunt-Thru** or **Series-Thru measurement mode**.

Shunt-Thru and Series-Thru are based on a S21 Transmission measurement. *Bode 100* measures S21 and the *Bode Analyzer Suite* calculates impedance from the S21 measurement. Details on the calculation can be found in [8.2.3 Shunt-Thru](#) on page 66 and [8.2.5 Series-Thru](#) on page 69.

You can either calibrate the underlying S21 measurement using Thru calibration **or** you can use Open/Short/Load calibration to move the reference plane directly to the DUT.

 Shunt-Thru and Series-Thru allow **both**, Thru **or** Open/Short/Load calibration. **However, only one calibration can be active at a time!** Even if both calibrations have been performed only one calibration is applied. You must select the calibration you want to apply using the slider in the calibration dialog. If the arrow points to the left, Thru calibration is applied. If the arrow points to the right, Open/Short/Load calibration is applied (see example below).

Thru calibration  Open/Short/Load calibration

#### Shunt-Thru calibration connections

Calibrating Thru:

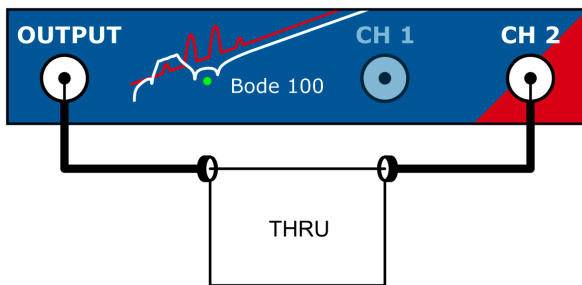

Thru calibration can e.g. remove the gain and phase error introduced by the connection cables including a coaxial common mode transformer that is generally used in this measurement to suppress the cable-braid error.

Calibrating Open/Short/Load:

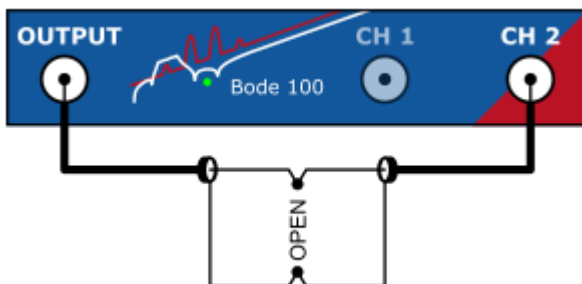

Open calibration.



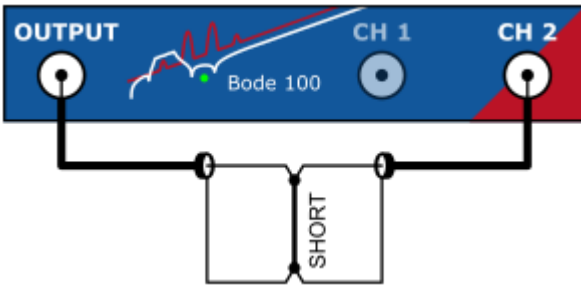

Short calibration.  
 Note that the inductance of the short connection is assumed to be zero. Short Delay Time is 0 s by default. This means that inductance of the short connection will be subtracted from the measurement result. This might be important to consider when you try measuring several nH of parasitic inductance.

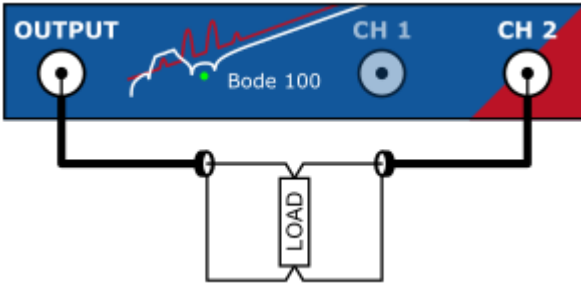

Load calibration.  
 Default Load Resistor value is 50 Ω.

**Series-Thru calibration connections**

Calibrating Thru:

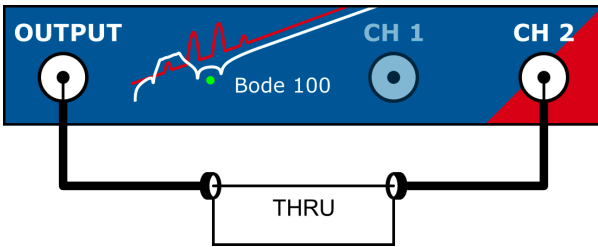

Thru calibration can e.g. remove the gain and phase error introduced by the connection cables.

Calibrating Open/Short/Load:

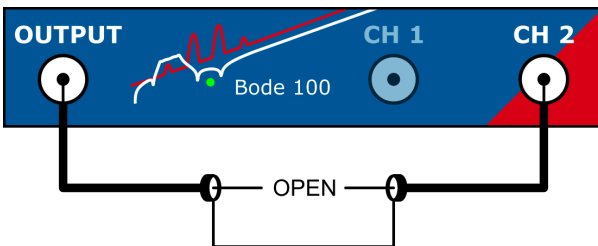

Open calibration.  
 Note that the capacitance of the Open is assumed to be zero. If you try to measure very low capacitance, the parasitic capacitance of the Open can introduce an error. Try keeping it as small as possible.

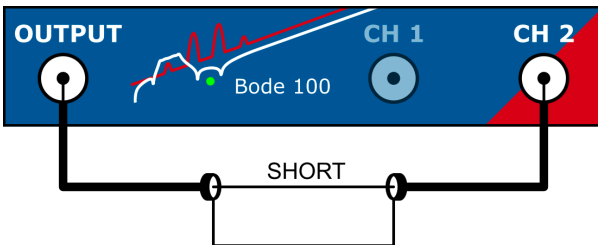

Short calibration.  
 Note that the inductance of the short connection is assumed to be zero. Short Delay Time is 0 s by default.

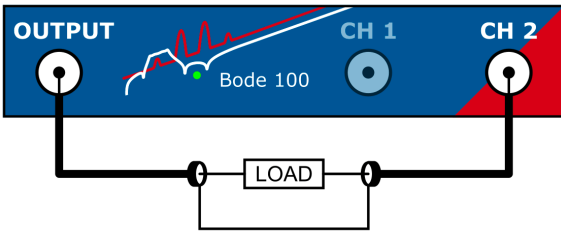

Load calibration.  
Default Load Resistor value is 50  $\Omega$ .

For more details and practical examples on how to perform calibration in the Shunt-Thru or Series-Thru measurement mode, please refer to the corresponding application notes on [www.omicron-lab.com](http://www.omicron-lab.com).

### 10.3.5 Calibrating a Voltage/Current measurement

In this section you learn how to calibrate an Impedance, Reflection or Admittance measurement in the **Voltage/Current measurement mode**.

The Voltage/Current measurement mode is based on an Gain measurement. *Bode 100* measures Gain from Channel 1 to Channel 2. Impedance equals Gain if Channel 1 receives a current signal and Channel 2 receives a voltage signal. The *Bode Analyzer Suite* allows to either calibrate the underlying Gain measurement using Thru calibration or to use Open/Short/Load compensation to move the reference plane directly to the DUT.

- i The Voltage/Current measurement allows **both**, Thru **or** Open/Short/Load calibration. **However, only one calibration can be active at a time!** Even if both calibrations have been performed only one calibration is applied. You must select the calibration you want to apply using the slider in the calibration dialog. If the arrow points to the left, Thru calibration is applied. If the arrow points to the right, Open/Short/Load calibration is applied (see example below).

Thru calibration   Open/Short/Load calibration

#### Voltage/Current calibration connections

Calibrating Thru:

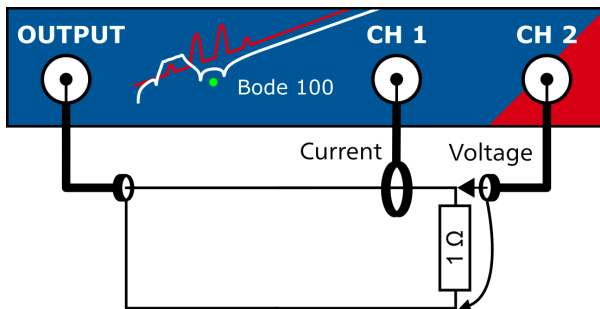

Use a 1  $\Omega$  resistor for Thru calibration. 1  $\Omega$  results in 1 V/A. Thru calibration can e.g. remove the gain and phase error introduced by the probes. However, it does not correct for systematic measurement errors in the measurement setup such as a voltage drop on the current probe or the current flowing through the voltage probe. These errors cannot be removed by one calibration measurement. In such a case you can use Open/Short/Load calibration to reduce these errors.

Calibrating Open/Short/Load:

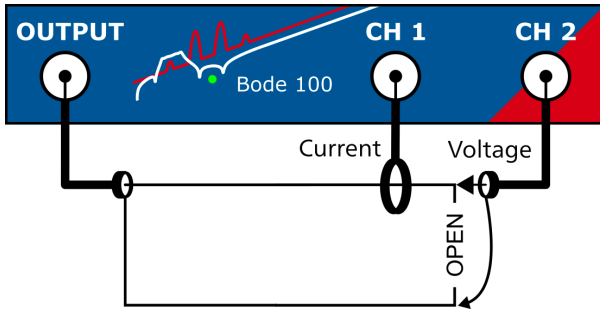

Open calibration.

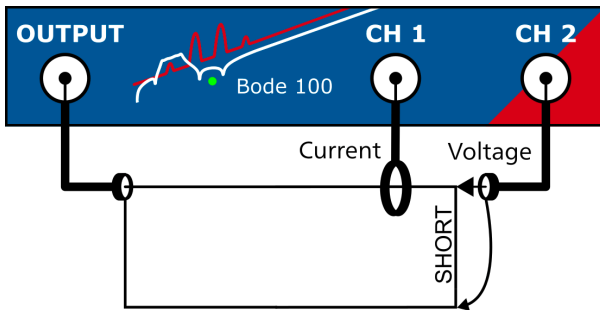

Short calibration.  
Note that the inductance of the short connection is assumed to be zero. Short Delay Time is 0 s by default.

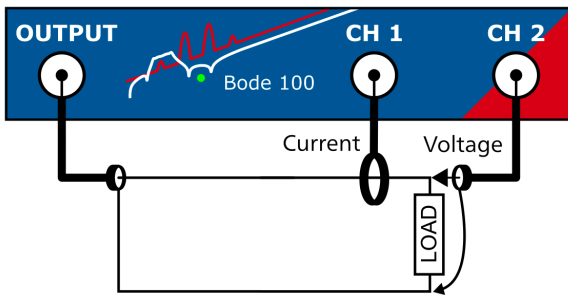

Load calibration.  
Default Load Resistor value setting is 50  $\Omega$ .

For more details and practical examples on how to perform calibration in the Voltage/Current measurement mode, please refer to the corresponding application notes on [www.omicron-lab.com](http://www.omicron-lab.com).

## 10.4 Further calibration information

### 10.4.1 Difference between Full-Range and User-Range calibration

**Full-Range** calibration and **User-Range** calibration differ only in the **frequencies** that are used to measure the correction factors.

**Full-Range** calibration measures the correction factors over the "**full**" **frequency range** of the instrument at factory-predefined frequencies.

**User-Range** calibration measures the correction factors at **exactly** the same **frequency range** and frequency points that are used in the **measurement** currently configured by the user.

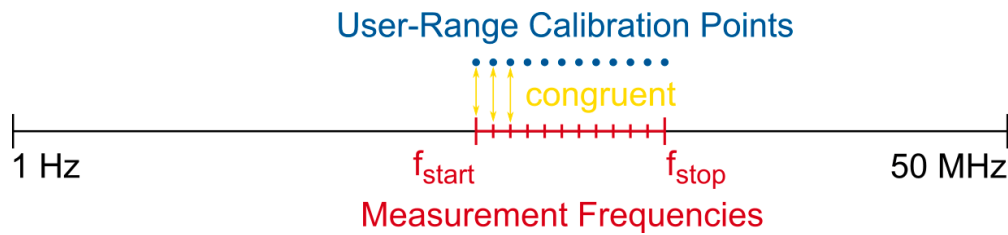

Figure 10-7: User-Range calibration; measurement frequencies and calibration frequencies are congruent.

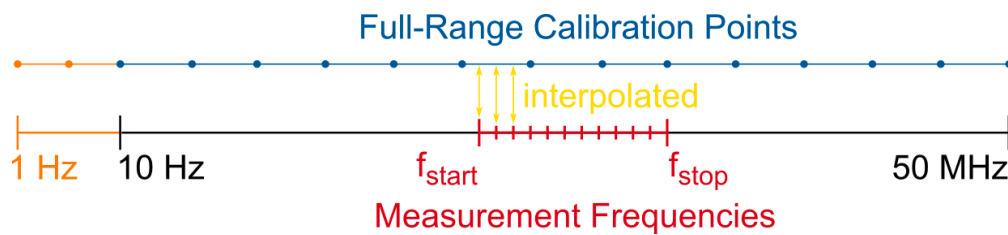

Figure 10-8: Full-Range calibration; correction factors are interpolated at measurement frequencies.

If Full-Range calibration is applied, the correction factors are available at the pre-defined frequencies only. Correction factors for the measurement frequencies are calculated by interpolating between the measured points.

- i Full-Range calibration is by default performed from 10 Hz to 50 MHz. If you need to calibrate below 10 Hz, check out [10.3.4 Full-Range calibration below 10 Hz](#) on page 106  
 In a single-frequency measurement the User-Range calibration will contain only one frequency.  
 In a frequency sweep measurement the User-Range calibration contains exactly the same amount of points as the sweep measurement.

### Advantage of the Full-Range calibration

Full-Range calibration allows you to change the measurement frequencies without losing the calibration. Since the correction values are interpolated, they can be interpolated for all frequencies chosen in the measurement.





### Advantage of the User-Range calibration

User-Range calibration does not use interpolation. The correction values are measured at exactly the same frequencies as used in the measurement. This results in highest accuracy especially when using long cables or narrow-band probes that show significant gain/phase shift in the measurement range.

- i User-Range calibration is deleted immediately when the measurement frequencies are changed!

### 10.4.2 Enabling and disabling a calibration

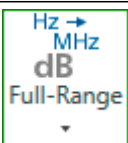
After a calibration has been performed, the calibration is automatically activated by the *Bode Analyzer Suite*. Since a calibration can be manually enabled or disabled, the calibration icons indicate the current state of a calibration. In the following table the calibration states are explained based on the Gain calibration. The same rules apply to impedance calibration:

	<p>Full-Range Gain calibration is <b>not performed</b> (not available) and <b>not active</b>. The icon has no background fill and no border.</p>
	<p>Full-Range Gain calibration has been performed and <b>is active</b>. The green border indicates that the calibration is available (has been performed). The green background fill indicates that the calibration is activated.</p>
	<p>Full-Range Gain calibration is <b>enabled</b> but <b>not active</b>. The green border indicates that the calibration is available (has been performed) and was enabled by the user. Since there is no background fill, the calibration is not active. This can happen if a User-Calibration overrules the Full-Range calibration. Both calibrations have been enabled but the software decides to use the User-Range calibration (see information below).</p>
	<p>Full-Range Gain calibration is <b>available</b> but <b>not enabled</b> and <b>not active</b>. The gray border indicates that the calibration is available (has been performed) but it is currently not enabled and therefore also not activated.</p>

 User-Range calibration and Full-Range calibration can be performed and activated at the same time. However, if a valid User-Range calibration has been performed, the *Bode Analyzer Suite* will automatically choose the User-Range calibration to be active.

**Example:**

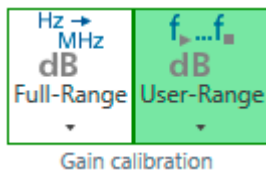



Both, Full-Range and User-Range Gain calibration have been performed.  
Therefore both calibration icons have a green border.  
The software however chooses User-Range calibration to be active.  
This is indicated by the green fill of the User-Range icon. By clicking on the Full-Range calibration icon, the user could force the Full-Range calibration to be active.

### 10.4.3 Re-performing a calibration

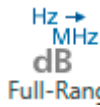
A calibration can be performed by clicking on the corresponding calibration icon in the Home ribbon.



- Clicking on a calibration icon (e.g. Full-Range Gain calibration ) opens the calibration dialog

- The calibration measurement can be started by clicking the start button 

- After the calibration is  the calibration dialog can be closed

- The calibration icon turns green indicating that the calibration is now active 

From now on, this calibration is used for the measurement.

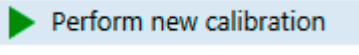
-  A calibration can be disabled and enabled by clicking on its calibration icon.
-  To re-performed a calibration, open the calibration dialog by clicking on the arrow on the bottom of the calibration icon . Then select . Calibration can then be re-performed by pressing the *Start* button.

### 10.4.4 Full-Range calibration below 10 Hz

Full-Range calibration measures between 10 Hz and 50 MHz at factory pre-defined frequencies. Full-Range calibration normally starts at 10 Hz to reduce calibration time.

-  If you decide that frequencies between 1 Hz and 10 Hz must be included in the Full-Range calibration, you must set the *Start Frequency* to a value <10 Hz before executing the Full-Range calibration.

Alternatively User-Range calibration might be more applicable in that case.

#### Full-Range calibration frequency range:

- If Start Frequency is set  $\geq 10$  Hz, then Full-Range calibration will run from 10 Hz to 50 MHz
- If Start Frequency is set <10 Hz, then Full-Range calibration will run from 1 Hz to 50 MHz



If a Full-Range calibration has been performed at a *Start Frequency* >10 Hz and *Start Frequency* is changed to a value <10 Hz after calibration, the correction value at 10 Hz will be extrapolated to 1 Hz. This is indicated by an **orange** Full-Range calibration icon. Re-performing calibration will run the calibration from 1 Hz and the icon will turn green again.

Note that the calibration takes significantly longer when it starts at 1 Hz.

### 10.4.5 Automatic deletion of calibration

In order to avoid false measurements or an invalid calibration, the *Bode Analyzer Suite* automatically deletes calibration as soon as a setting makes the calibration invalid. The following lists show which settings will delete a calibration when they are changed.

#### Deleting User-Range calibration

User-Range calibration is automatically deleted when one of the following settings is changed:

- Measurement frequencies (Start Frequency, Stop Frequency, Center Frequency, Span)
- Sweep Mode (Linear or Logarithmic)
- Number of Points (in the frequency sweep)
- Channel termination (1 M $\Omega$  or 50  $\Omega$ )
- Reference / receiver connection (Internal or External)
- External probe factor

#### Deleting Full-Range calibration

Full-Range calibration is automatically deleted when one of the following settings is changed:

- Channel termination (1 M $\Omega$  or 50  $\Omega$ )
- Reference / receiver connection (Internal or External)
- External probe factor

### 10.4.6 Saving calibration data

User-Range and Full-Range calibration data is saved to the .bode3 file.

The calibration data (correction values) as well as the calibration states (activated or not) are stored to the file. When opening a bode-file the *Bode Analyzer Suite* attempts to load the external calibration data and calibration states from the file.



The *Bode Analyzer Suite* attempts to load the calibration from the bode-file even when the calibration has been performed with a different *Bode 100* device.

#### Hardware incompatibilities between *Bode 100 R1* and *Bode 100 R2*

- Full-Range calibration from *Bode 100 R1* is not compatible to Full-Range calibration of *Bode 100 R2*. Full-Range calibration will be deleted automatically when opening a bode-file created with a different hardware revision.
- User-Range calibration is not compatible in the frequency range from 3 kHz to 30 kHz. A User-Range calibration that contains frequencies in that range will be deleted automatically when opening a bode-file created with a different hardware revision.

## 10.4.7 Exporting calibration data

User-Range and Full-Range calibration data can be exported to a .mcalx file for the use in the Automation Interface.

To do so, click on the export icon  **Export** in the **File** ribbon . This will open the export pane where you can select the calibration export  **Calibration Export**. The following picture shows the export settings:

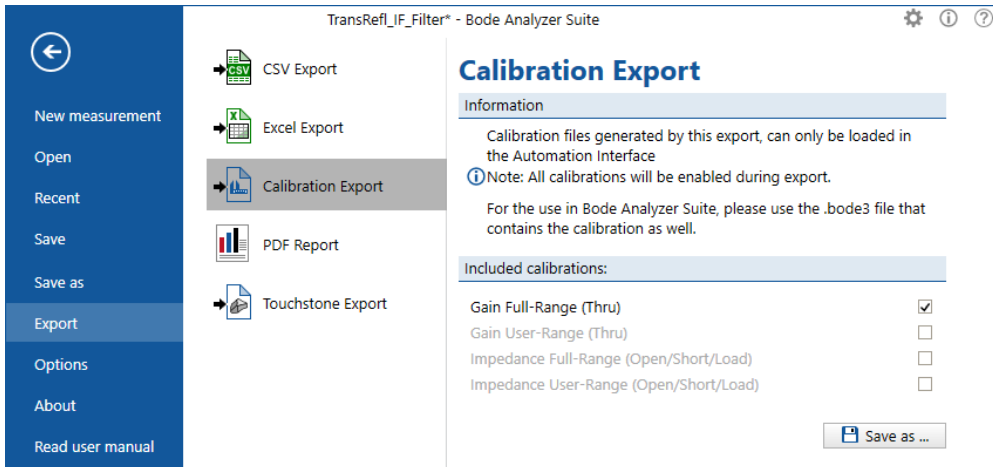

In the calibration export pane, you can select any available calibration to be exported. A .mcalx file can contain more than one calibration. When loading in the Automation Interface, any usable calibration will be loaded and activated if possible. Please make sure that the device settings in the *Automation Interface* match the settings in the *Bode Analyzer Suite*.



The .mcalx file can be loaded **only** in the Automation Interface (see: [12 Automating measurements](#) on page 154 !

To save a calibration for use in the *Bode Analyzer Suite*, please simply save the measurement file (.bode3) that contains the calibration as well.



# 11 Bode Analyzer Suite software features

The following chapters contain information about important features of the *Bode Analyzer Suite*. Read through these chapters to learn how to use *Bode 100* efficiently.

## 11.1 Exporting and saving measurement data or settings

The *Bode Analyzer Suite* supports a variety of possibilities to save measurement configurations and measurement data. In the following these are explained in detail.

### 11.1.1 Loading and saving the equipment configuration

You can store all settings of *Bode 100* including the device configuration, measurement settings, calibration and measurement data and the graphical display settings by clicking the Save toolbar button.



This functionality allows you to store multiple equipment configurations for repetitive measurement tasks. With the equipment configurations stored, you can load the respective files for each measurement instead of setting the *Bode 100* manually.

A file saved by the *Bode Analyzer Suite 3* has the file extension **.bode3**. The *Bode Analyzer Suite 3* supports loading files with the following file extensions:

- **.bode3** files created with *Bode Analyzer Suite 3*
- **.bodex** files created with *Bode Analyzer Suite 2.42* or *2.43*
- **.bodz** files created with *Bode Analyzer Suite 2.41*
- **.bode** files created with *Bode Analyzer Suite 2.41* or older



You can save and load **.bode3** files on different *Bode 100* devices. Note, however, that calibration data might be deleted when opening the **.bode3** file with a different hardware revision. More details can be found in [Hardware incompatibilities between Bode 100 R1 and Bode 100 R2](#) on page 107.

### 11.1.2 Use the clipboard functions to export data

The *Bode Analyzer Suite* offers several possibilities to quickly export data via the clipboard. The following information can be copied to the clipboard to ease your documentation work:

- An image file of the result diagram
- The measured trace data
- The equipment settings in form of text

#### Copy a chart image to the clipboard

Right-click the chart or diagram you want to copy and select  **Copy image to clipboard**.

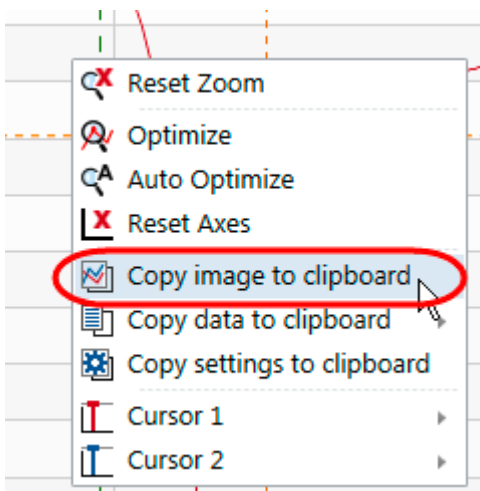

This will place an image file of the clicked diagram to the Microsoft Windows clipboard that can be pasted to e.g. Microsoft Word. All frequency sweep charts, fixed frequency charts and the shaped level chart can be copied as an image to the clipboard.



You can configure how the chart image looks like by using the  Options → Clipboard.

**Chart**

Font scaling factor:

Trace thickness factor:

Image format:

Include legend:

Include cursor table:

Position:

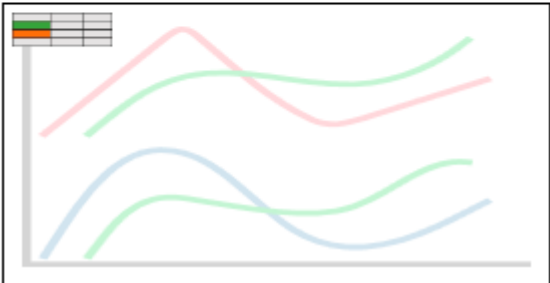

**Font scaling factor:** Use this number to increase the font size of axis labels in the copied diagram.

**Trace thickness factor:** Use this number to increase the weight of the trace line in the copied diagram.

**Image format:** *Bode Analyzer Suite* will use the vector graphics format EMF for the diagram image if possible. In case you experience issues with the EMF files, you can also change the image format to PNG.



**Include legend:** Activate the checkbox to include a legend. This is of advantage when multiple traces are present in the diagram.



**Include cursor table:** Activate the checkbox to include the cursor table in the copied image. In addition you can specify the position of the cursor table in the interactive picture below the checkbox.

### Copy trace data to the clipboard

Right-click either in the chart or directly on the trace name to copy the measured data to the clipboard.

 **Copy data to clipboard** Copied data can directly be pasted in a spreadsheet program for further data processing or can be pasted as a memory trace into another instance / measurement of *Bode Analyzer Suite*.

 To move data from one measurement file to another, you can also use drag & drop by grabbing a memory or measurement trace at the dotted area  in the trace header.

 You can configure the decimal separator and the field separator under  Options → Clipboard.

### Copy settings to the clipboard

Right-click in the chart and select  **Copy settings to clipboard**. This will copy a text block to the clipboard that contains the current equipment settings. The text block is similar to the settings header included in the CSV or Excel file export.

## 11.1.3 Use the clipboard to import data

You can use the clipboard to import data into a measurement file. There are two possible sources for the data:

1. A measurement trace or memory trace from another .bode3 file / Bode Analyzer Suite.
2. User-specific data from a spreadsheet program.

In any case, the data will be imported as a memory trace inside the *Bode Analyzer Suite*.

### Paste trace data from another .bode3 file / Bode Analyzer Suite

Before you can paste data from another .bode3 file, you must copy the data into the clipboard. Right-click the trace you want to copy, use  **Copy data to clipboard** and select the corresponding trace.

 You can only paste single traces. If you use "Copy all traces" you cannot paste the data into another file.

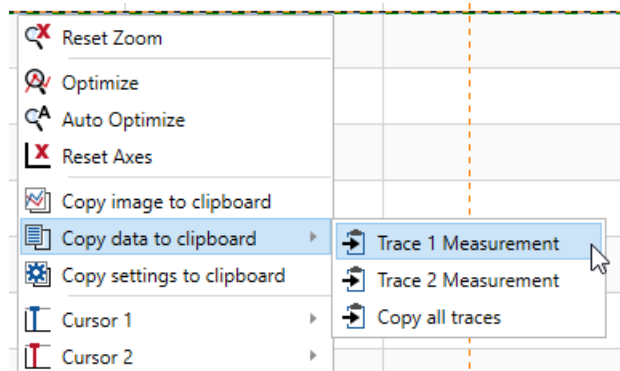

After you have copied the trace data to the clipboard, the *Bode Analyzer Suite* will show a "Clipboard → new memory" button on the right-hand lower corner:

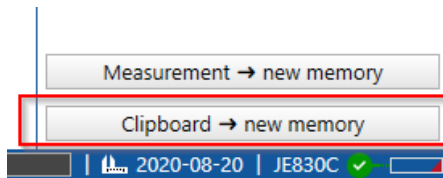

Click the button to paste the trace data into any .bode3 file.

**i** *Bode Analyzer Suite* does not check for data validity. You can mix Gain and Impedance data. Please make sure to copy and paste the right data. If your measurement has Gain and Impedance data, *Bode Analyzer Suite* will show a selection possibility which data to paste.

### Paste / import data from a spreadsheet program

You can also import data from i.e. a spreadsheet program as a memory trace into the *Bode Analyzer Suite*. To do so, you must copy data into the clipboard that can be interpreted as trace data. Please consider the following rules:

- The first column is always interpreted as the frequency in Hz.
- The first line (header) will be skipped if it does not contain numerical data.
- The second column is interpreted as the real part of the complex number.
- The third column is interpreted as the imaginary part of the complex number.
- The complex number is always interpreted as either a Gain value or as an Impedance value.
- Use the same field separator and decimal separator as configured in the options! You can find them under Options → Clipboard.

The following table shows an example of data that can be imported if the decimal separator is chosen to be the dot and the field separator the tab.

Frequency	Real	Imaginary
1001.56	50.6	1e-6
10005.98	60.9999	100.89E-8
100700	0.777E02	0.00000125

You can also use five columns, then the interpretation follows the order Frequency, Gain, Impedance:

Frequency	Gain		Impedance	
	Real	Imaginary	Real	Imaginary
data	data	data	data	data

**i** There might be a situation where the amount of data in the clipboard does not fit the amount of available measurements in a .bode3 file. In such a case, *Bode Analyzer Suite* will show a selection possibility where you can choose to select Gain or Impedance data or choose to paste data as Gain or Impedance.



### 11.1.4 Exporting measurement data to CSV or Excel files

If you need to further process the measurement data the *Bode Analyzer Suite* offers to save the measurement data either as a CSV file or in form of a Microsoft Excel compatible spreadsheet file. To save your measurement data as a .csv or .xlsx file, click on the Export Icon in the Home ribbon



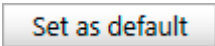

#### Exporting a CSV file

In the CSV export pane you can choose the following options:

Include settings header	Include a header in the csv file that contains device settings. <b>Note:</b> The height of the header is not constant. Please take care when parsing the csv file automatically.
Include active memory traces	All memories that are currently visible in the <i>Bode Analyzer Suite</i> will be exported to the csv file.
Include output level	Includes the output level as the second column (after frequency) of the csv file. Might be important for shaped level measurements.
Include real & imaginary values	Real and Imaginary are included independently of the currently chosen display format in the GUI.
Decimal separator	Choose your decimal separator of choice.
Field separator	Configure the separator between two values / fields.
Open file after saving	Activate this function to open the exported file with an external program. When activated a text box appears that allows you to choose your program file. Leave the text box empty to use the default Windows program.
	Press this button to store your settings for future exports. You can find the default settings also in the options dialog accessible in the main window via  .
	Press the <b>Save as</b> button to specify a file name and save your export file.

## Exporting an Excel file

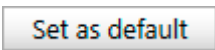
In the Excel export pane you can choose the following options:

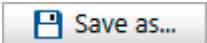

Include settings header	Include a header in the csv file that contains device settings. <b>Note:</b> The height of the header is not constant. Please take care when parsing the csv file automatically.
Include active memory traces	All memories that are currently visible in the <i>Bode Analyzer Suite</i> will be exported to the csv file.
Include output level	Includes the output level as the first column of the csv file. Might be important for shaped level measurements.
Include real & imaginary values	Real and Imaginary are included independently of the currently chosen display format in the GUI.
Open file after saving	Activate this function to open the exported file with an external program. When activated a text box appears that allows you to choose your program file. Leave the text box empty to use the default windows program.
	Press this button to store your settings for future exports. You can find the default settings also in the options dialog accessible in the main window via  .
	Press the <b>Save as</b> button to specify a file name and save your export file.

### 11.1.5 Generating a Touchstone file

*Bode Analyzer Suite* 3.0 offers the possibility to create Touchstone files from the measured data. This offers you the possibility to use measured data directly in simulators that provide Touchstone import.

You can find the Touchstone export using the  **Export** icon in the Home ribbon.

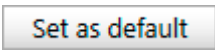

The Touchstone export pane offers the following options:

Network parameter	Choose between S, Y and Z parameters.
Number of ports	Either 1-Port or 2-Port touchstone file can be created.
Network data	Select the measurement trace or memory trace data that corresponds to the network parameter.   <i>Bode Analyzer Suite</i> does not check if the data is valid. Please take care that you choose the correct measurement for your network parameters. If the frequencies of the traces or memories are not equally spaced, they cannot be selected since Touchstone only allows one frequency column for all network parameters.
Network data format	MA...Magnitude and Angle (Default) DB...Magnitude in dB and Angle RI...Real and imaginary
Frequency unit	Select Hz, kHz, MHz or GHz. Hz is default.
Touchstone version	Default is Touchstone V2. A Touchstone V2 file can be saved under the extension .ts, .s1p or .s2p depending on the number of ports. The file extension .ts is default. A Touchstone V1 file has either the .s1p or .s2 extension.
Number format	Choose SixDigitsFixed or SixDigitsScientific
Open file after saving	Activate this function to open the exported file with an external program. When activated a text box appears that allows you to choose your program file. Leave the text box empty to use the default Windows program.
	Press this button to store your settings for future exports. You can find the default settings also in the options dialog accessible in the main window via  .
	Press the <b>Save as</b> button to specify a file name and save your export file.

## 11.1.6 Generate a PDF report

If you need to print a measurement report or save it as a PDF document, you can use the PDF export. To do so, click the  **Report** icon in the Home ribbon.

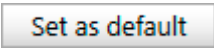
The PDF report pane offers the following options:

Include legend	Activates a chart legend in the diagrams. This is of advantage if you have many curves in the diagrams. However it can reduce the diagram size slightly.
Include cursor table	Includes the cursor table in the report.
Include shaped level	Include information about the output level in the report.
Include comments	Includes the text notes from the main window in the report. Note: Only plain text is included in the report.
Use the CUSTOM template	<p>No: <i>Bode Analyzer Suite</i> automatically selects the optimal report template for your measurement.          Yes: <i>Bode Analyzer Suite</i> uses the custom template that can be modified.</p> <p><b>Note:</b> In this case the custom template will be used no matter what type of measurement you perform and how many charts are displayed in the main screen.</p> <p> The default custom report template is intended to be a starting point for customizing your own report.</p> <p>You can find the custom template file at:  <code>%appdata%\OMICRON Lab\Bode Analyzer Suite\ReportTemplates\3.25\template_sweep_custom.xlsx</code></p>
Open file after saving	Is activated by default. If you don't enter a program path in the text field below, the default Windows program for PDF files will be used to open your saved PDF report.
	Press this button to store your settings for future exports. You can find the default settings also in the options dialog accessible in the main window via  .
	Press the <b>Save as</b> button to specify a file name and save your report.



## 11.2 Using the interactive chart

The interactive chart region of the *Bode Analyzer Suite* offers many useful functions to analyze measurement results and how to display them in an optimum way. In the following sections the most important features are presented.

### 11.2.1 Configure the diagrams

A normal diagram with frequency on the x-axis can have up to two y-axes. This allows to display two measurement traces in one diagram as shown in the figure below:

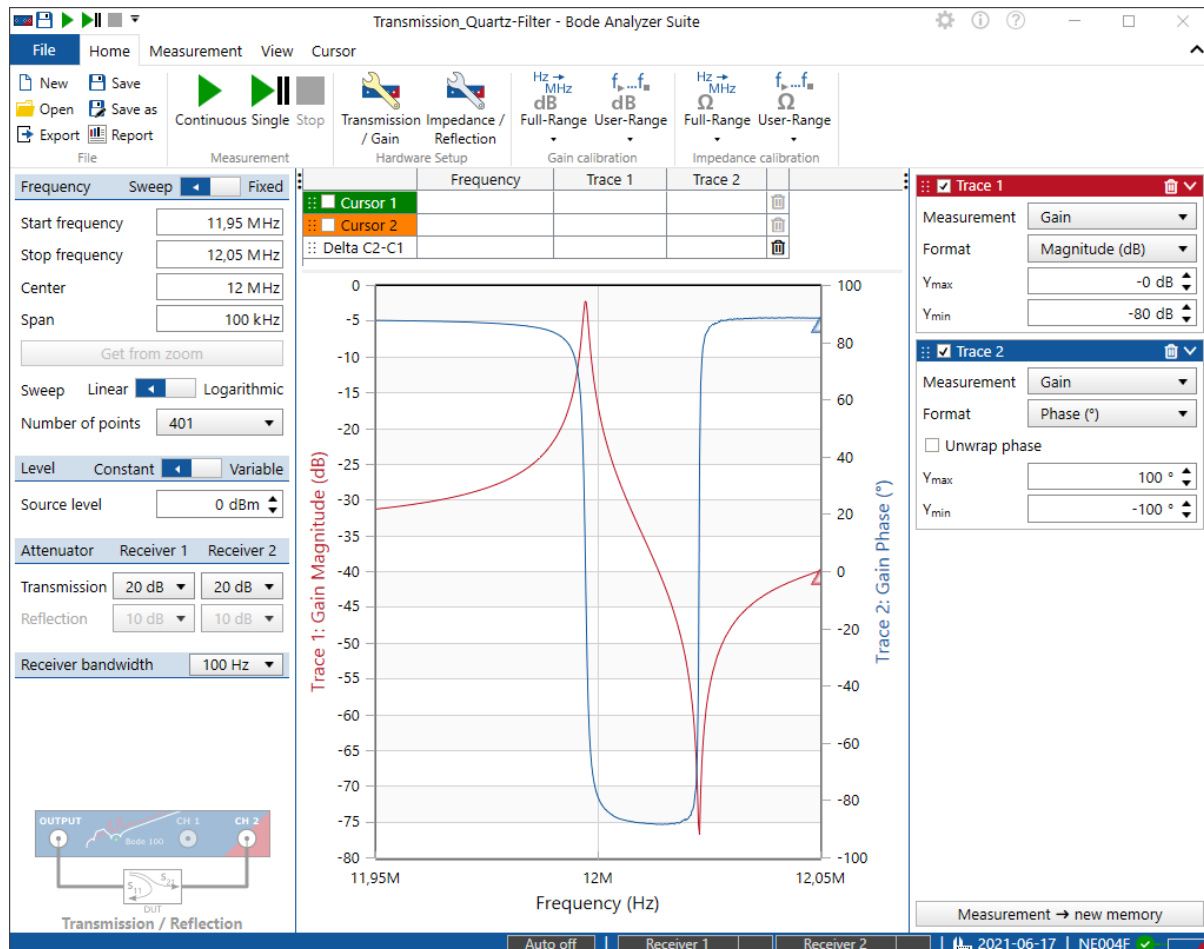
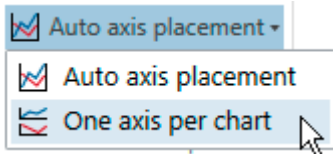

Figure 11-1: Two measurement traces in one diagram using two axis (left and right)

**i** It is not always possible to display two traces in one diagram. If one of the two traces is set to a Polar, Smith, Nyquist or Nichols diagram, automatically two diagrams will be displayed.

You can also choose to show the two curves in two separate diagrams. To do so, click on the **View** ribbon and select **One axis per chart** as shown below.



This results in two separate diagrams as shown below.

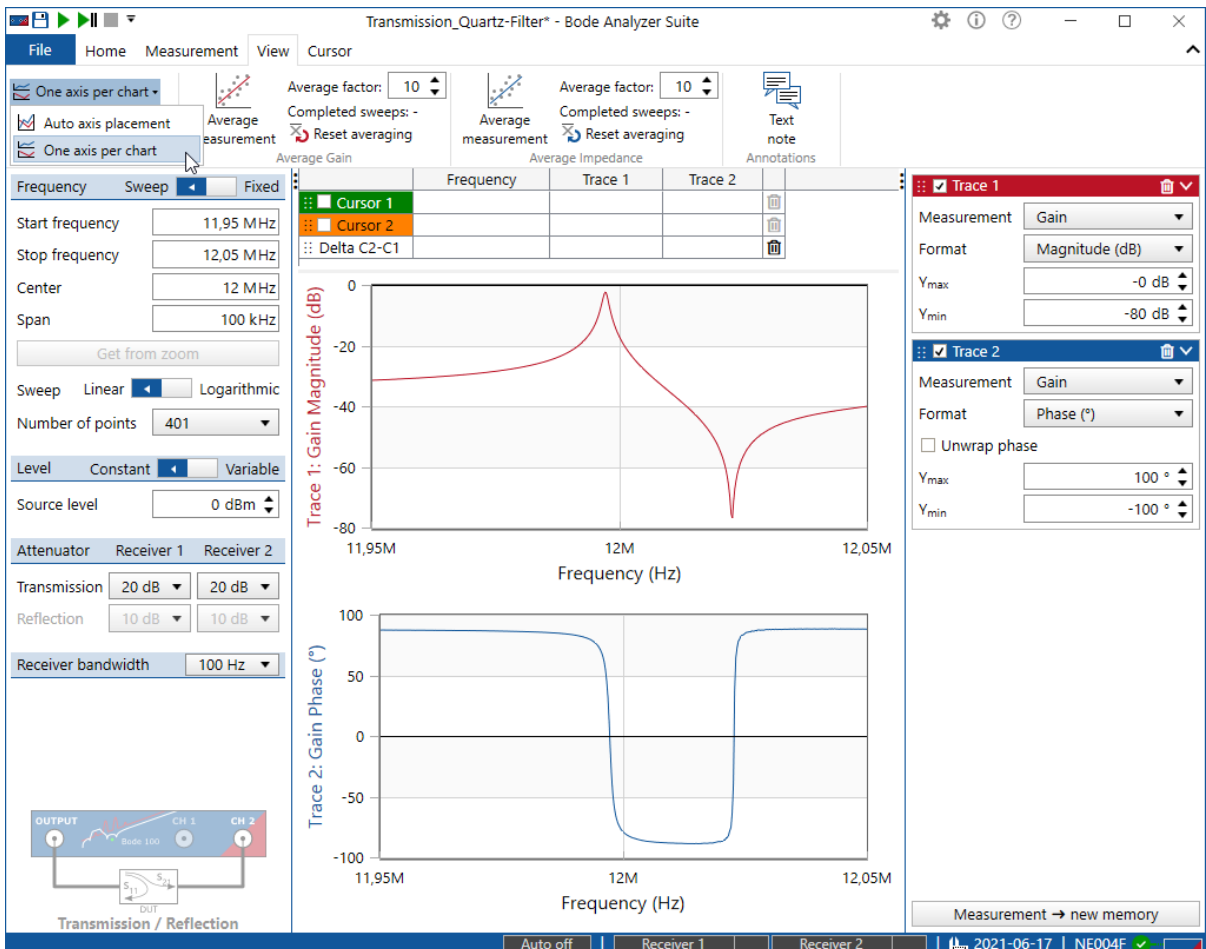



Figure 11-2: Displaying two traces in a separate diagram setting the chart setup to **One axis per chart**

 You can configure your preferred style in the [options menu](#) under the Chart Settings.

## 11.2.2 Zooming the measurement curve

### Zoom into a measurement curve

To zoom into an interesting part of your measurement curve, click into the chart and hold the mouse clicked to drag a zoom window from **top-left** to **bottom-right** as shown in the following figure:

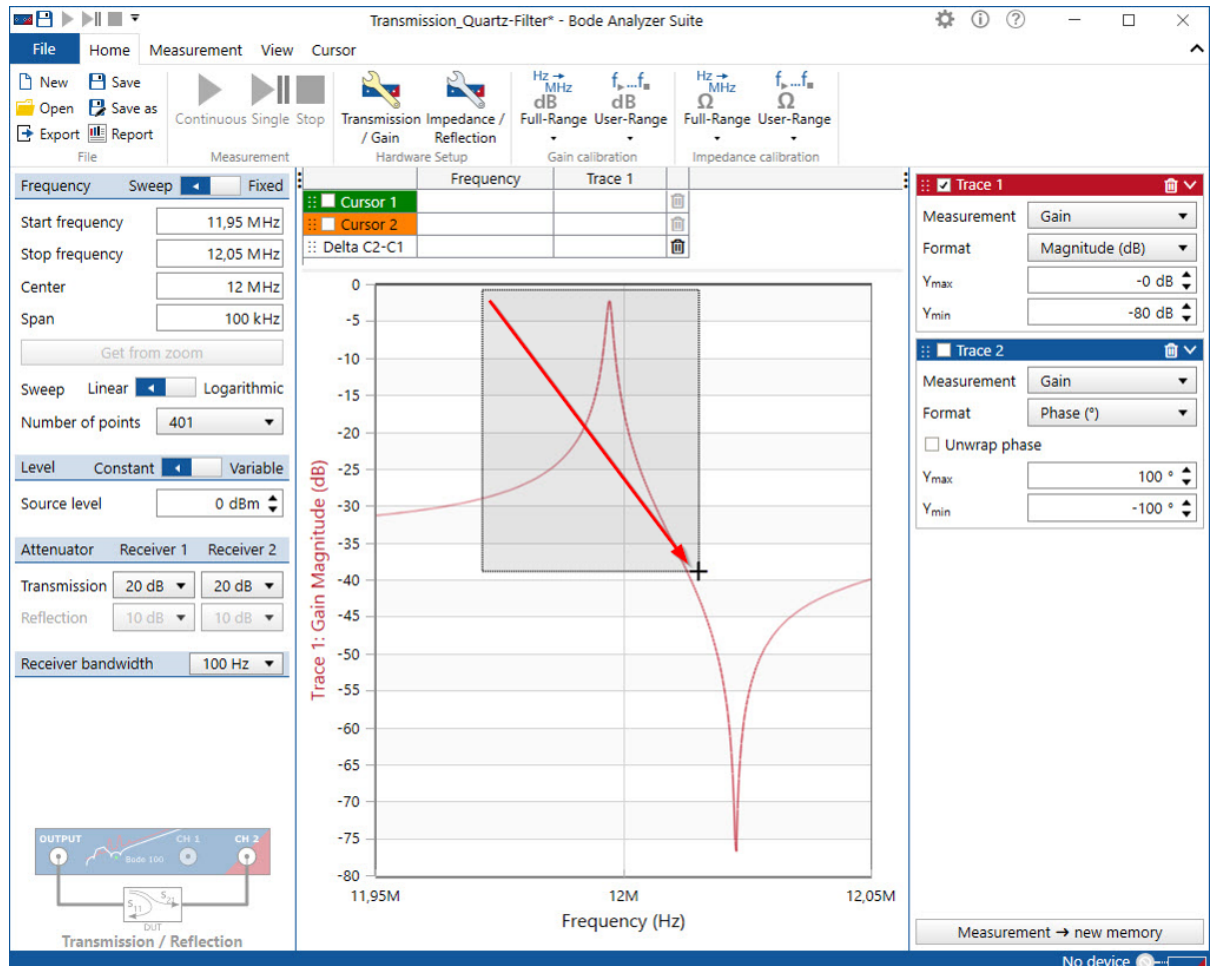

Figure 11-3: Zooming in by click and drag from top-left to bottom right

Whenever you have zoomed in the diagram, the axis label shows additional arrows to indicate that a zoom is active.

◀◀ Frequency (Hz) ▶▶

◀◀ Trace 1: Gain Magnitude (dB) ▶▶

## Zoom out

To zoom out, click into the chart and drag from **bottom-right** to **top-left** as shown in the figure below:

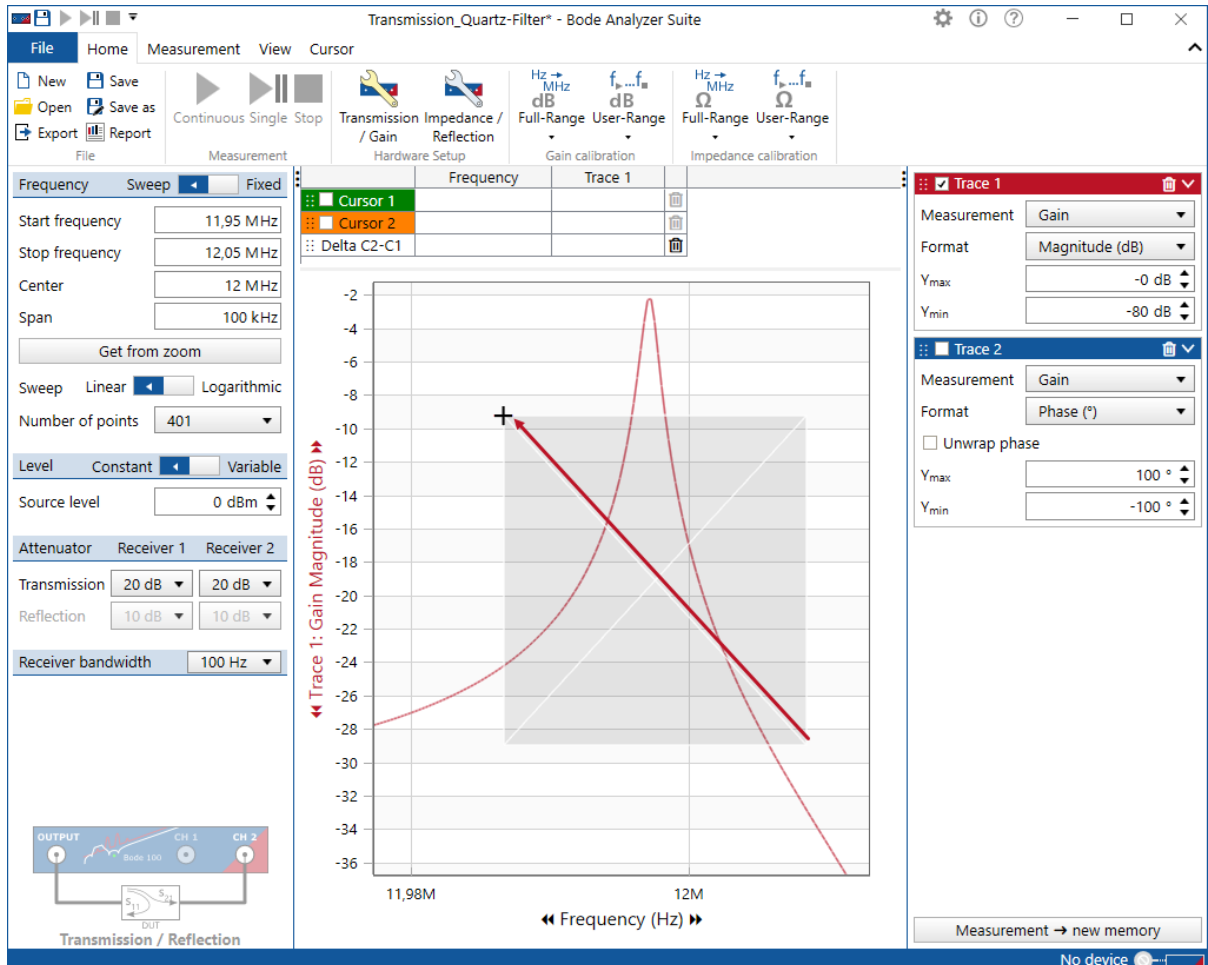

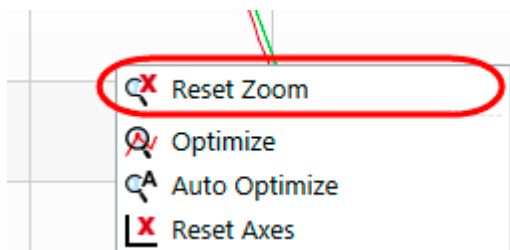

Figure 11-4: Zooming out by click and drag from bottom-right to top-left

Alternatively you can right-click into the chart and use the  **Reset Zoom** function in the context menu of the chart as shown below.



### Get from zoom

Zooming helps to check an interesting part of a measurement curve. However, zooming into the curve does not increase the number of measured points which can lead to insufficient frequency resolution.

To achieve a better frequency resolution you can either increase the number of points in the sweep or press the  button.

By clicking **Get from zoom**, the start and stop frequency fields are updated with the maximum and minimum frequency of the current zoom window.

After clicking on Get from zoom you can start a new sweep with the full number of points in the current zoom window. The following figure shows the effect in case of a narrow resonance. The green memory trace shows the measurement result before clicking Get from zoom. After clicking Get from zoom, the resonance is captured nicely. After pressing Get from zoom, the zoom is not active anymore and the button is disabled.

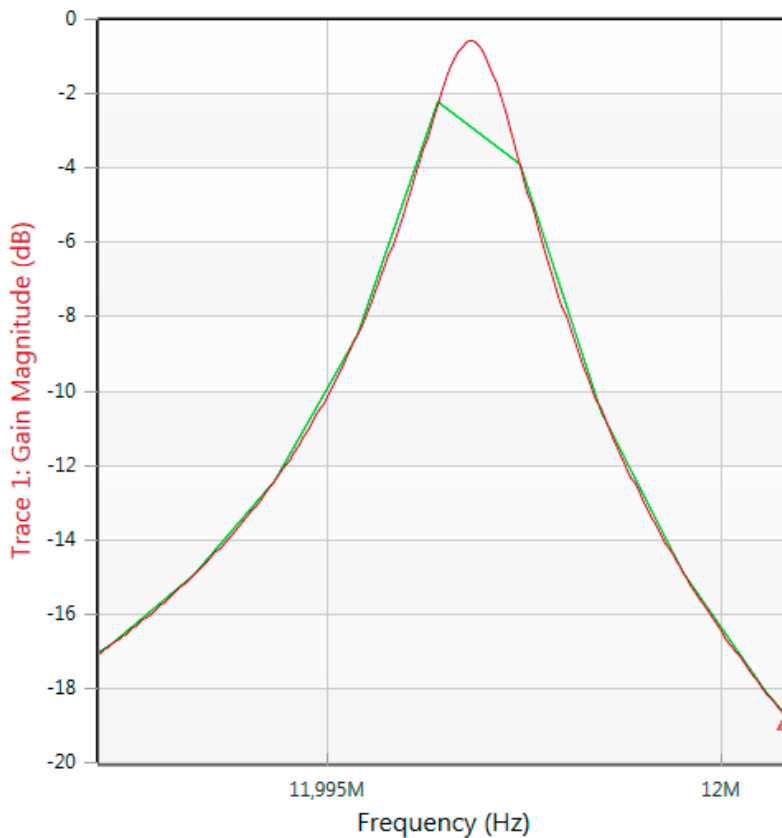

Figure 11-5: Increasing the frequency resolution in a zoom window using **Get from zoom**

## 11.2.3 Optimize the axis scaling / autoscale

### Manually configuring the chart axes

Every measurement trace of the *Bode Analyzer Suite* has axis settings.

A normal diagram with frequency on the x-axis has two y-axis settings (Ymax and Ymin) as shown below:

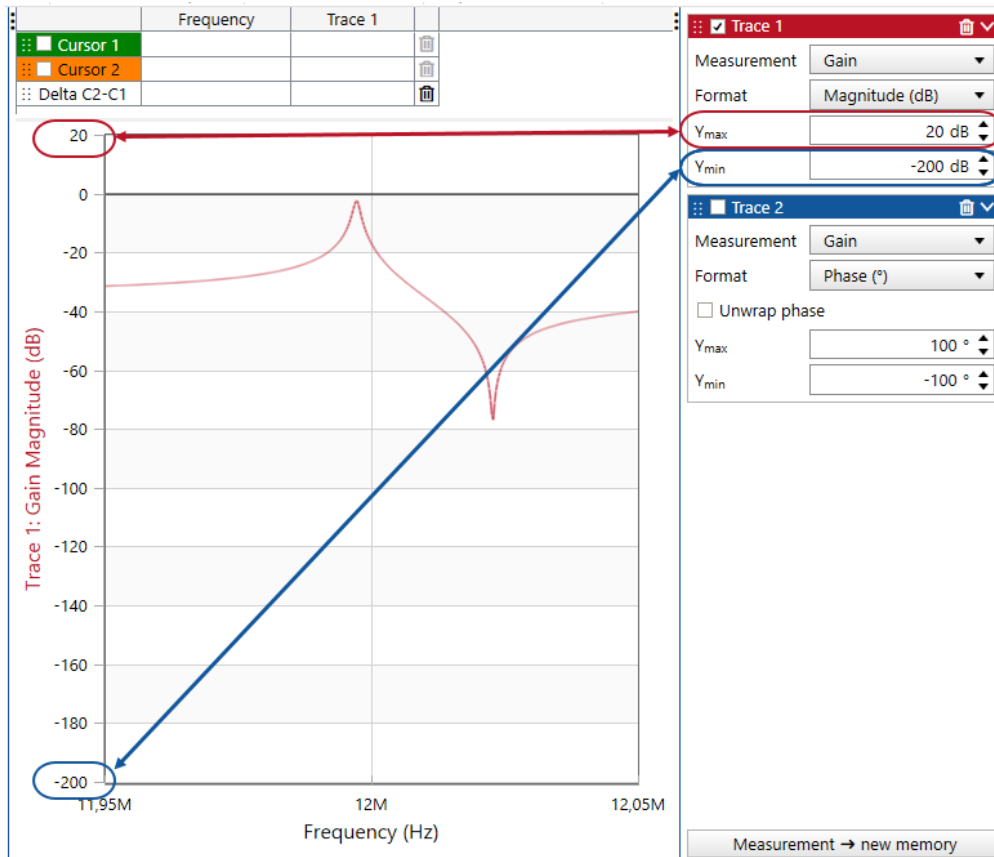



Figure 11-6: Manually configuring the axis limits via the trace configuration

**i** Diagrams such as Polar, Nyquist or Smith have more axis settings to allow to choose the visible range in the diagram.

**Use Optimize to automatically optimize the axis scaling**

To automatically optimize the axes of your measurement curve, right-click into the chart and click  **Optimize**.

After clicking optimize the axis settings are automatically adjusted as shown below:

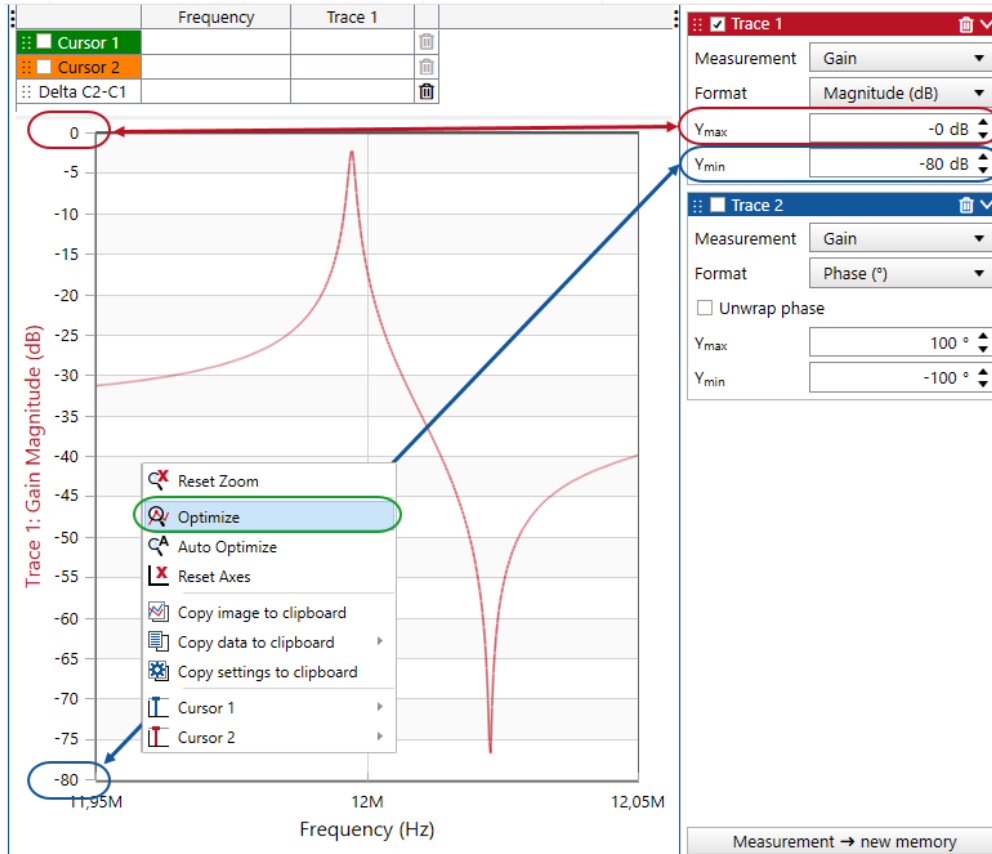

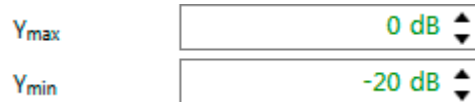



Figure 11-7: Use Optimize to automatically adjust the axis settings

## Use Auto-Optimize

If you don't want to click  **Optimize** every time the measurement curve changes, you can use the  **Auto Optimize** function available in the context menu of the chart.

When activated,  **Auto Optimize** automatically adjusts the axis limits whenever the measurement results change. To display that the Auto Optimize is activated, the Ymax and Ymin text color is changed to green :



 Each of the following user interactions will deactivate the Auto-Optimize:

- Zooming in the diagram
- Clicking Reset Zoom
- Clicking Optimize
- Manually adjusting the axis in the trace configuration
- Using Reset axes

## Reset axes

If you want to reset the chart axes to the default values, right-click into the chart and use  **Reset Axes** .



## 11.3 Working with cursors and the cursor table

The *Bode Analyzer Suite* offers cursors (markers) to read the exact value of a trace at a specific frequency. In the following, a short overview on the functionality of cursors is given.

### 11.3.1 The cursor table

The cursor grid respectively cursor table shows the values of normal value-cursors and delta-cursors. A delta-cursor can be configured to show the difference between two cursors whereas a normal value-cursor shows the value of a trace at a specific frequency.

	Frequency	Trace 1	
<input checked="" type="checkbox"/> Cursor 1	10,4 MHz	-55,74 dB	
<input checked="" type="checkbox"/> Cursor 2	10,8 MHz	-33,112 dB	
<input type="checkbox"/> Delta C2-C1	400 kHz	22,628 dB	

The cursor table offers the following interactive functions:

- Switch cursors on and off by clicking on the checkbox besides the cursor name
- Delete a cursor by clicking on the recycle-bin icon in the last column. Note that a cursor cannot be deleted if it is used by some other function such as a delta-cursor. Then the recycle-bin icon is greyed out.
- Move the cursor up or down in the cursor table by clicking on the dotted area left to the checkbox and drag it to the desired position holding the mouse clicked.

<input checked="" type="checkbox"/> Cursor 1	10,4 MHz	-55,74 dB	
<input checked="" type="checkbox"/> Cursor 2	10,8 MHz	-33,112 dB	
<input type="checkbox"/> Delta C2-C1	400 kHz	22,628 dB	

- Set the cursor frequency by clicking into the frequency field and manually entering a frequency

	Frequency
<input checked="" type="checkbox"/> Cursor 1	11,997 MHz

- Move the cursor to a specific measurement result by entering the desired value in the Trace

	Frequency	Trace 1
<input checked="" type="checkbox"/> Cursor 1	11,997 MHz	-905,561 mdB

- You can also enter a delta value and the second cursor will try to find a frequency where the delta value can be achieved.

If an entered value cannot be found, the following information is shown.

Frequency	Trace 1
11,997 MHz	-905,561 mdB
10,000 MHz	-7,152 dB

Value not found in visible field!

If multiple solutions are present (e.g. more than one zero-crossing and you entered 0 into the cursor grid), you can right click into the cursor grid and click  **Jump to next** to search the next solution from the current frequency to right (higher frequency).

### Changing the cursor line style

You can modify the cursor line style by right-clicking the colored cursor field and using the context menu as shown in the following figure.

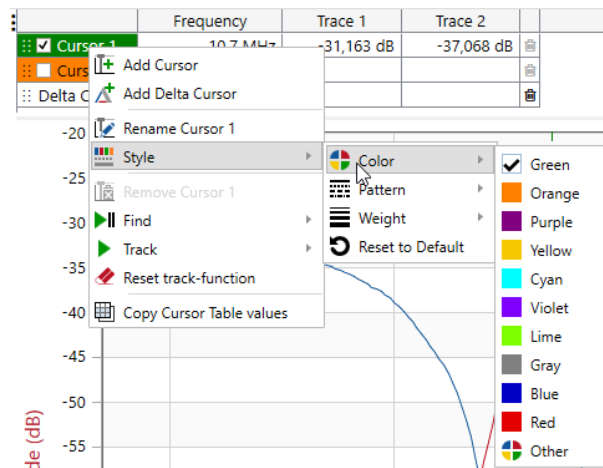

### Further cursor features in the context menu

By right-clicking a cursor in the cursor table the cursor context menu allows you to use the following features:

- **Add Cursor** and **Add Delta Cursor** to add a new cursor in the cursor table.
- **Rename Cursor** to give a cursor a custom name.
- **Find** or **Track** to search a maximum, minimum or zero-crossing of a trace either once or repetitively after every sweep.
- **Reset track-function** stops tracking a maximum or minimum or zero crossing.
- **Copy Cursor Table values** allows you copy all cursor result into the clipboard at once and paste them e.g. in a spreadsheet program.

## 11.3.2 Using cursors in the chart

### Moving cursors in the chart via mouse drag

You can move the cursors in the chart via the mouse. Simply move the mouse cursor close to the cursor you would like to move until the mouse cursor changes to , then click and drag the cursor to the position you like. Alternatively you can use the left and right arrow keys of your keyboard to move the cursors. Note, this will always move the cursor that was last moved using the mouse.

### Find or Track Maximum, Minimum or Zero-crossing in a trace

To find a maximum, minimum or zero crossing of a curve, you can use the functions in the context menu.

Right-click a curve in the diagram. Then select e.g. Cursor 1, Jump to Max to position Cursor 1 to the maximum of the clicked curve.

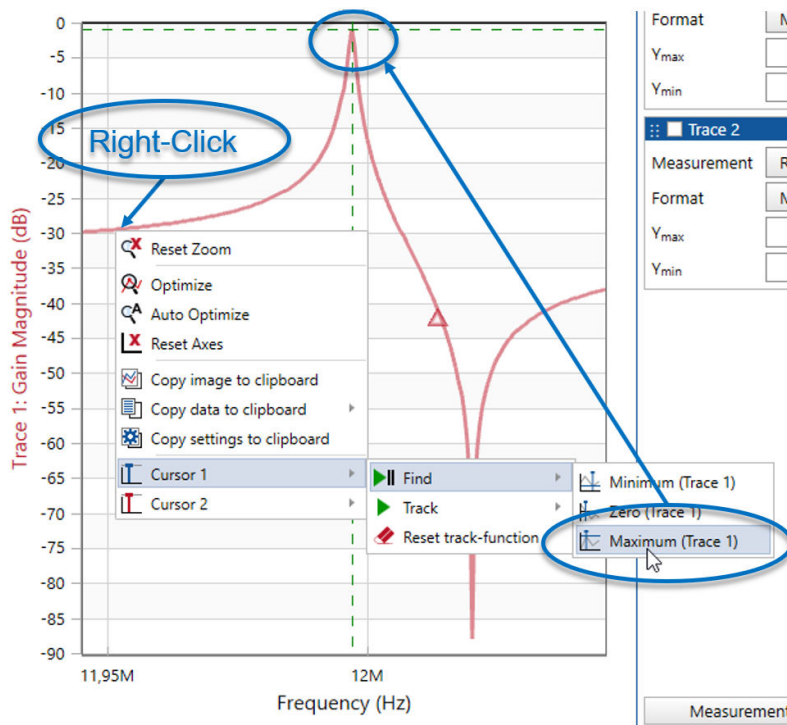
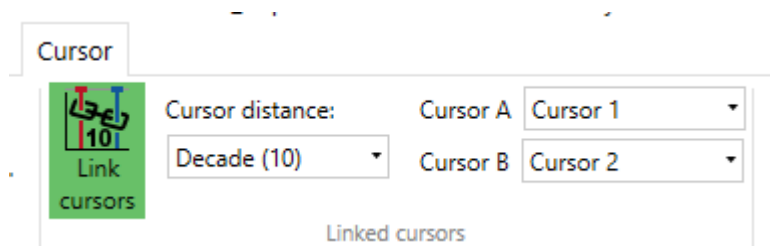

Figure 11-8: Use cursor function Find Maximum

- i **Hint:** Find max or min always searches the global max or min in the visible chart region. To find a local max or min, you can zoom into that region and re-perform Jump to Max.
- i **Hint:** If you use **Track** instead of **Find**, the maximum, minimum or zero crossing will be automatically searched every time a sweep as completed. This is especially useful when you use fast sweeps.

### 11.3.3 Link cursors

Two cursors can be linked in terms of the distance on the frequency-axis by clicking on Link cursors. If you move Cursor A with the mouse, Cursor B will follow at the defined distance or factor.



The linking features the following settings:

- Decade...the distance between Cursor A and Cursor B will be kept constant at one decade (linear factor of 10).
- Octave...the distance between Cursor A and Cursor B will be kept constant at one octave (linear factor of 2).
- Linear Distance...the distance between Cursor A and Cursor B will be kept at the current distance in Hz.

Cursor A and Cursor B need to be selected accordingly in the drop-down boxes in the ribbon.

**Application examples**

With this feature, the slope of a trace can be measured. This can be especially helpful in double-logarithmic diagrams when analyzing e.g. the slope at crossover frequency in a loop-gain measurement (should be around -20dB/decade) or when checking for an inductive or capacitive slope ( $\pm 20\text{dB/decade}$  or  $\pm 6\text{dB/octave}$ ).

The following picture shows an example of a measured loop gain where the slope at crossover is -5.7dB/octave and therefore close to the ideal -6dB/octave.

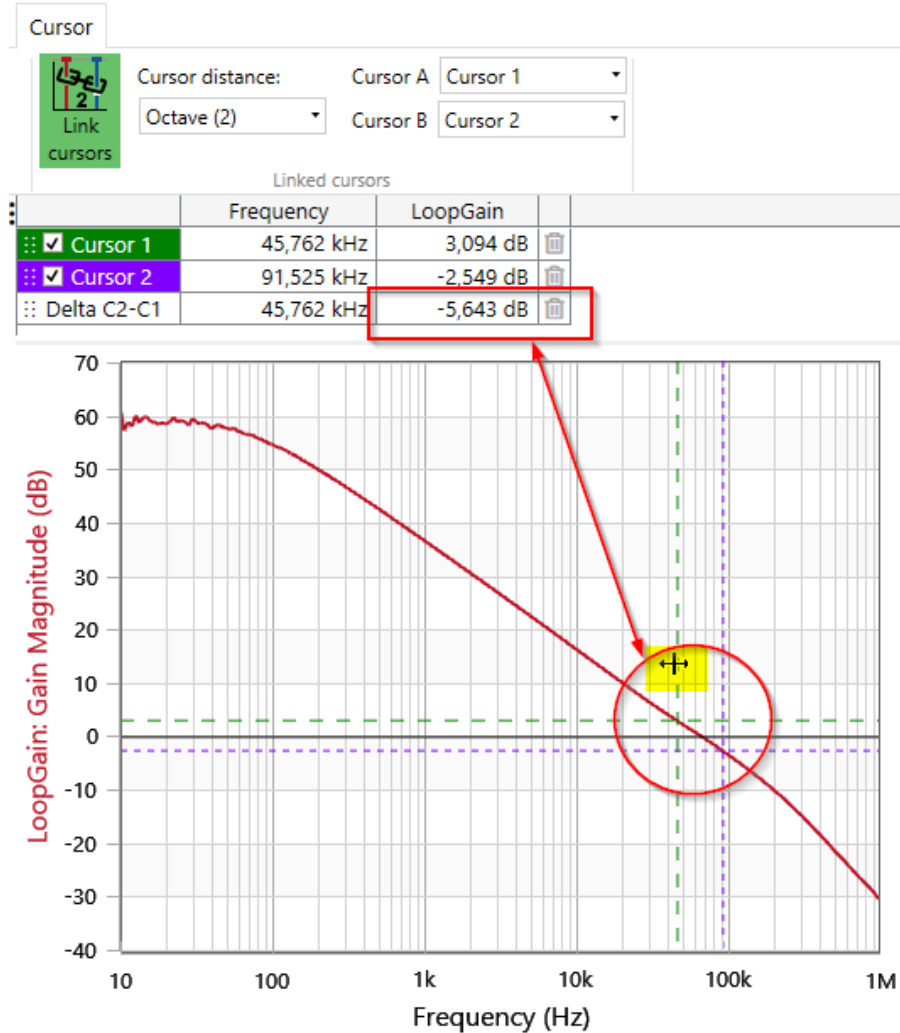

By using the mouse, the cursors can be moved from one frequency to another and the slope can be directly read in the cursor grid since the second cursor automatically follows at a defined distance.

## 11.4 Using the memory traces

The *Bode Analyzer Suite* offers you the possibility to compare multiple measurements with each other. To copy a current measurement result to a memory trace, use either the

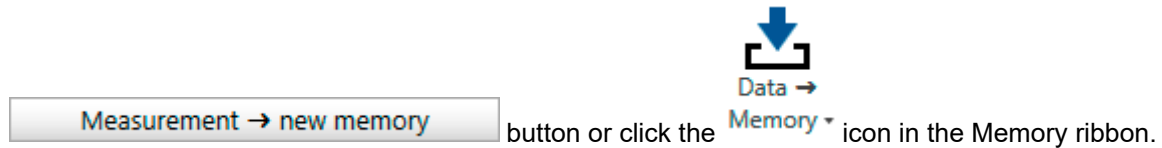

This will lead to a new curve in the diagram as shown in the figure below.

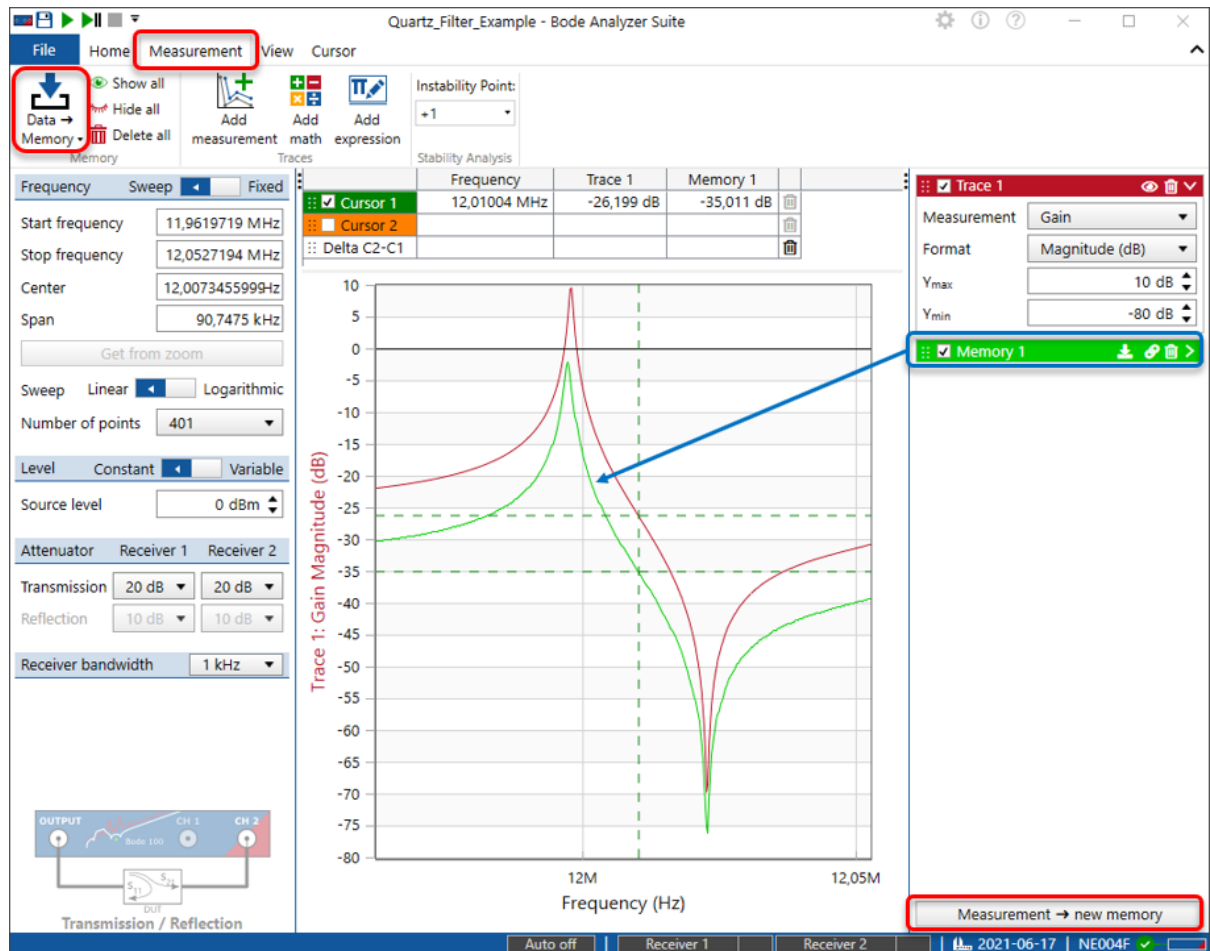

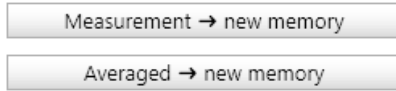

Figure 11-9: Using memory curves to see changes in the measurement and to compare different curves

 When you use averaging, a second button is available that allows you to copy the averaged value or the measured value to a memory trace.



You can use multiple memories to determine the change of your DUT depending on a parameter. The following figure shows an example of how the parallel resonance frequency of the quartz filter changes when touching it.

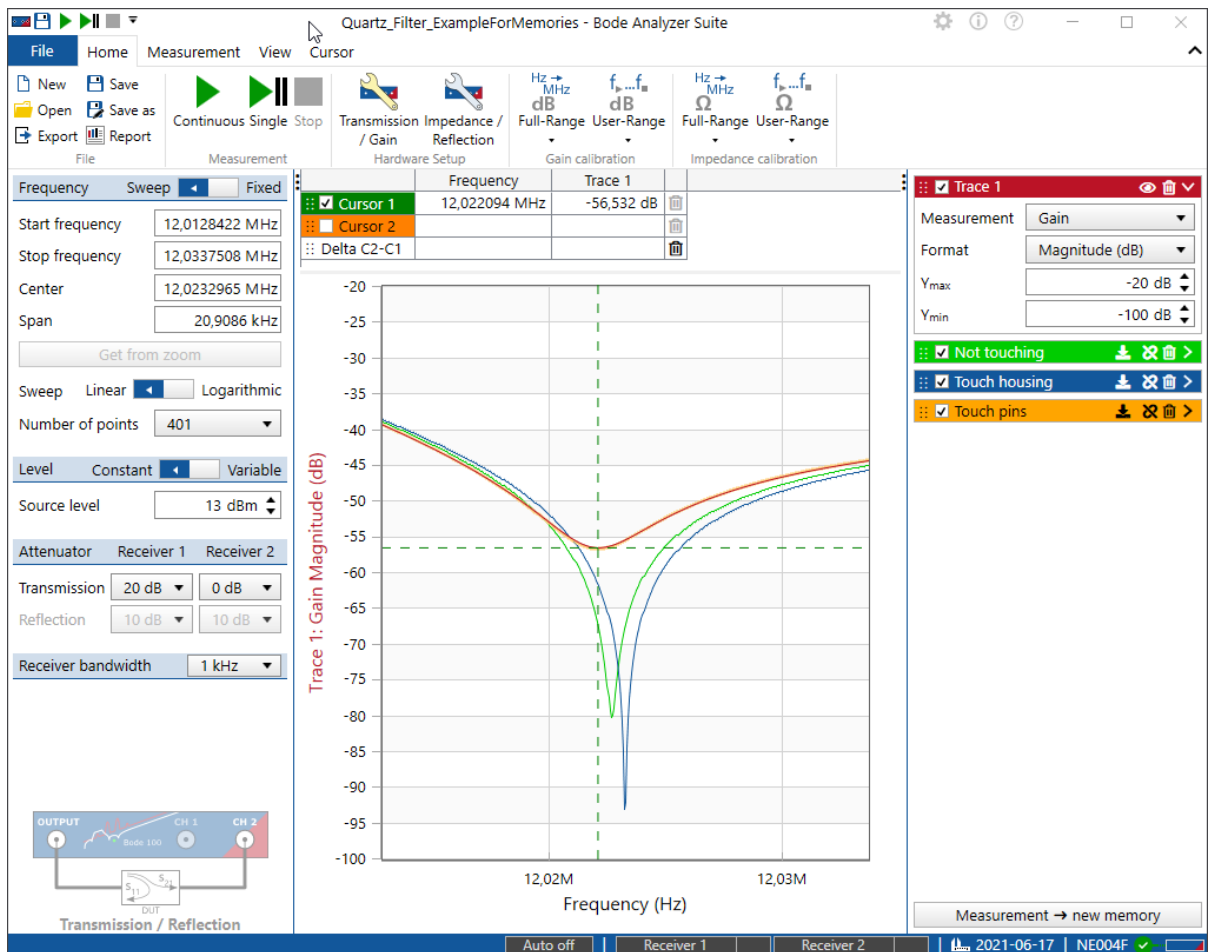





Figure 11-10: Using the memories to compare different measurements



**Hints:**







- Double-clicking the Memory name allows you to change the name of the memory.
- When you hover over the memory name on the memory configuration box, the corresponding memory curve will be highlighted in the diagram.

The memory configuration box gives you information on when the memory was stored and allows you to control the memory curves.



<input checked="" type="checkbox"/> Memory 1    	
Stored	2020-12-29 11:14:32
Impedance points	201
Show with	<input checked="" type="checkbox"/> Trace 1
	<input checked="" type="checkbox"/> Trace 2



The following actions can be taken:

- Click the checkbox  **Memory 1** next to the name to switch the memory curve on or off.
- Right-click the green area and use the context menu to change the memory style or color.
- Rename the memory by double-clicking on its name .
- Update the memory data with the current measurement data by clicking .
- Delete the memory trace by clicking on .
- Attach the cursors to the memory trace by clicking on .
- Use the **Show with** check-boxes to decide if the memory data shall be shown only with one trace or on both.
- Use the  icon to re-order memory traces in a measurement or to copy the data from one measurement file to another by drag-and-drop the trace from one *Bode Analyzer Suite* instance into another *Bode Analyzer suite* instance.

### Options

The following options can be configured in the memory options. Go to the options dialog  and select the memory options  **Memory** :

- **Maximum number of memory traces:** The maximum number of memory traces is by default limited to 10. If you need more memory curves increase this number.
  -  Increasing the number of memory traces might impact your software performance. Especially when you use a high number of points and many memory traces.
- **Confirm the deletion of memory traces:** When this checkbox is checked, the software will ask for confirmation when deleting a memory trace.
- **Default memory line pattern:** Change the memory line styles according to your preference.
- **Alternating memory trace color mode:** Activate this option to color-code the memory curves with the corresponding trace color. With this mode it is easier to distinguish between multiple memories when more than one trace is shown in a diagram.

## 11.5 Working with measurement and math traces

Please also check out [7.2.2 Trace configuration](#) on page 24 to learn more about using the trace configuration. Furthermore, please refer to the previous chapter [11.4 Using the memory traces](#) on page 130 on how to store a measurement trace to a memory trace.

Besides the memory traces, the *Bode Analyzer Suite* offers the following trace types:

- **Measurement traces** show the measured data
- **Math traces** allow simple math operations between measurement traces and memory traces
- **Expression traces** can handle more complex mathematical expressions

### Add an additional trace



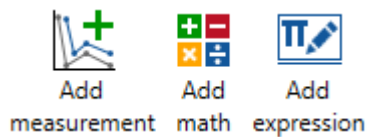

You can add additional measurement traces, math traces or expression traces by clicking on the corresponding icon under the **Measurement** ribbon.

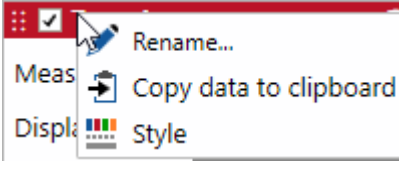

- i** Each of the above mentioned traces comes with its own axis respectively its own chart / diagram.  
If the chart setup is set to "one axis per chart", each trace will be shown in a separate chart / diagram.

Each trace brings its own trace configuration box on the right hand side of the *Bode Analyzer Suite*. The trace configuration allows you to configure how the data of the trace is displayed in the chart. The following table shows the trace configuration settings which are available for all trace types. Trace-specific settings are described in the following sections.

<b>Format</b>	Choose the desired format how to display the complex data. You can i.e. choose to select Magnitude or Phase(°) and so on. For more details on the available result formats, please refer to <a href="#">Gain Result Formats</a> on page 38 and <a href="#">Impedance Result Formats</a> on page 40.
<b>Ymax, Ymin, etc...</b>	Configure the axis limits of the trace axis (diagram). Please check out: <a href="#">11.2.3 Optimize the axis scaling / autoscale</a> on page 122. You can also right-click into the diagram and click <b>Optimize</b> . This will auto-scale the available axis.
<b>Y-axis scale:</b>	Choose either a linear Y-axis or a logarithmic Y-axis. In addition you can set it to $\text{Log}( Y )$ to avoid the logarithms of negative numbers.
<input checked="" type="checkbox"/> <b>Trace 1</b>	Use the checkbox left of the trace name to disable or enable the trace.
<b>Trace 1</b>	Rename the trace by double-clicking on the trace name.

	<p>Use the context menu to:</p> <ul style="list-style-type: none"> <li>• Rename the trace</li> <li>• Change the trace style (color, line style, trace markers)</li> <li>• Copy the trace data to the clipboard</li> </ul>
	<p>Collapse the configuration box if you have too many traces and need more space.</p>
	<p>Click on the bin icon to delete the corresponding trace.  <b>Note:</b> This will also remove the corresponding chart axis or chart!</p>
	<p>Click, hold mouse and drag to re-order the traces at the right-hand side of the Bode Analyzer Suite window.          This will also re-order the corresponding axis and diagrams.          Use drag and drop to move the measurement trace data from one measurement into another.</p>

### 11.5.1 Measurement traces

In the following the settings that are specific to a **Measurement trace** are described. The **Measurement trace** configuration box is shown in the figure below. It allows you to configure what measurement is performed and how the measurement results are displayed.

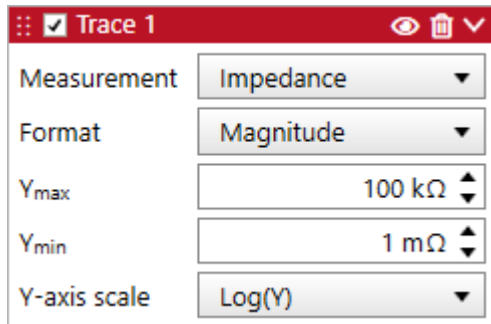

<p><b>Measurement</b></p>	<p>Configure what measurement the trace performs. Depending on the measurement mode you can select between Gain, Impedance, Reflection and Admittance. If a measurement mode allows only one specific measurement (Gain), the selection will be disabled.</p>
	<p>Use the eye icon to hide the measurement data in a chart.  <b>Note:</b> If you disable the a trace using the checkbox, the corresponding axis or chart will be removed as well.</p>

## 11.5.2 Math traces

For simple mathematical operations you can use the **Math trace** feature of the *Bode Analyzer Suite*. You can choose the two operands and the operator. The available **operands** are either the measurement data or memory data. The available operators are: **+**, **-**, **\***, **/**.

Use the **Math trace** to perform simple calculations such as the sum of two measurements or the difference between a measurement and a memory trace.

 **Note** that the mathematical operation of a math trace is always performed on the complex value selected in the **Measurement** setting. The result is then shown as selected in the **Format** setting.

The configuration box of a **Math trace** set to a *divide operation*, is shown below:

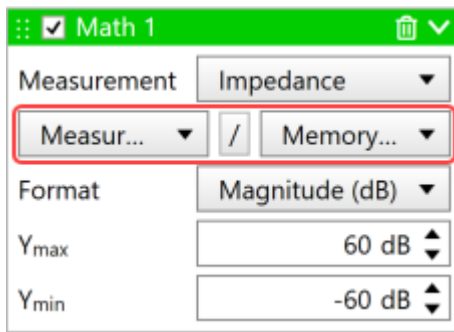

Some notes on the math trace:

- A **division** equals a **subtraction** in **logarithmic** domain. So if you choose *Measurement / Memory 1*, in the Magnitude(dB) plot you will see the difference between Measurement and Memory 1 in dB.
- A **multiplication** equals an **summation** in **logarithmic** domain. So if you choose *Measurement \* Memory 1*, in the Magnitude(dB) plot you will see the sum of Measurement and Memory 1 in dB.
- If the frequency points of the two operands don't match, an info icon will be shown in the trace header . Either linear interpolation will be used to find the needed operand values or the values will be skipped.
- A **Memory** cannot be created from of a **Math trace** .

### 11.5.3 Expression traces

For complex mathematical operations you can use the **Expression trace** feature of the *Bode Analyzer Suite*.

Adding an **Expression trace** automatically opens the **Expression Editor** in a separate window. The expression editor window can be moved around so that the resulting expression trace can be seen in the background as shown in the figure below.

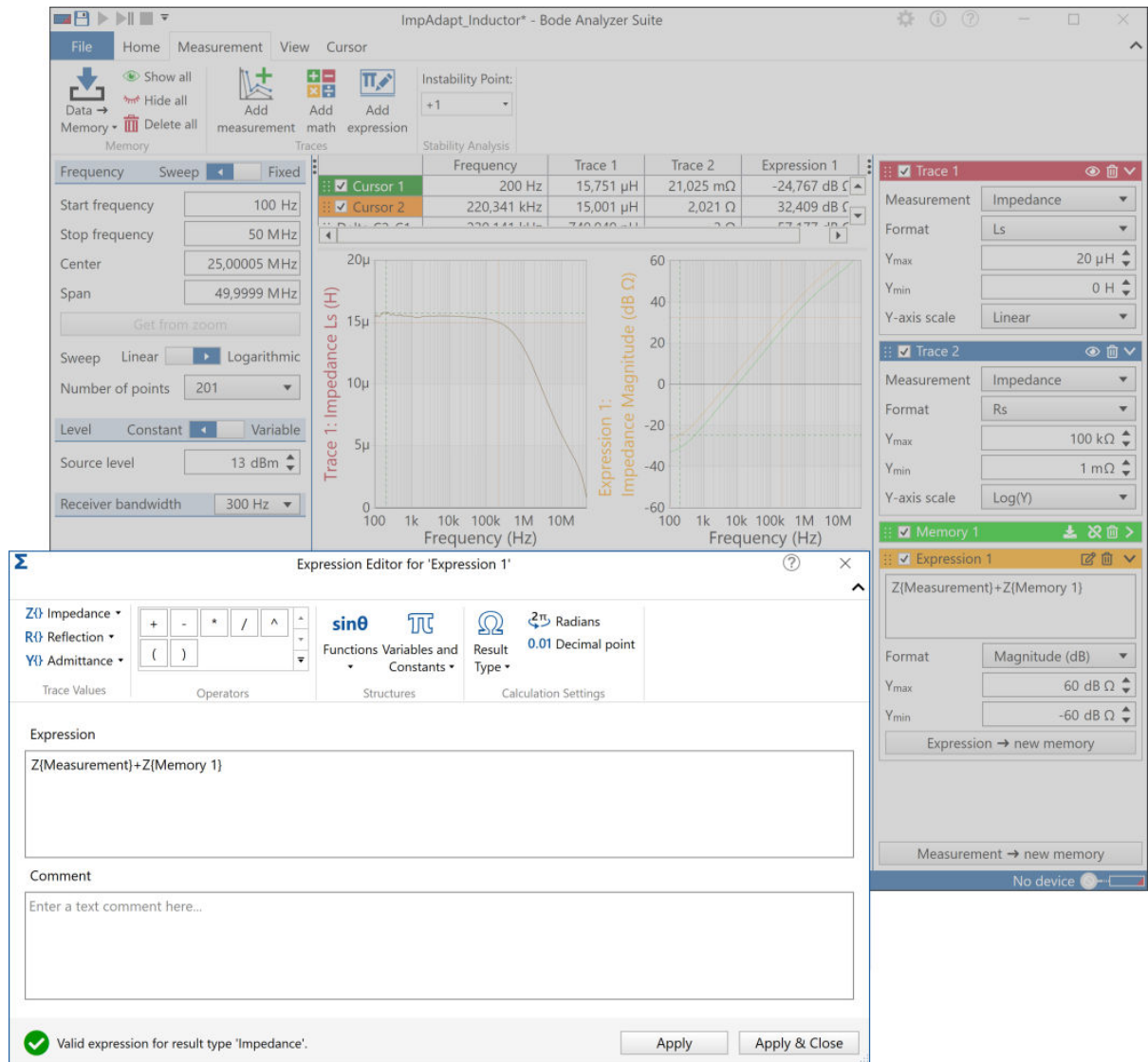

Figure 11-11: An example expression creating the sum of two impedance values plotting the result in the second chart.

**i** In case a **Measurement trace** is used in an expression, the expression result will be updated simultaneous with the running measurement.

## Expression editor

The **Expression editor** allows you to enter a custom mathematical expression. It offers various functions, variables and operators for simple calculations, to plot a transfer function or to perform advanced manipulation of the measured data.

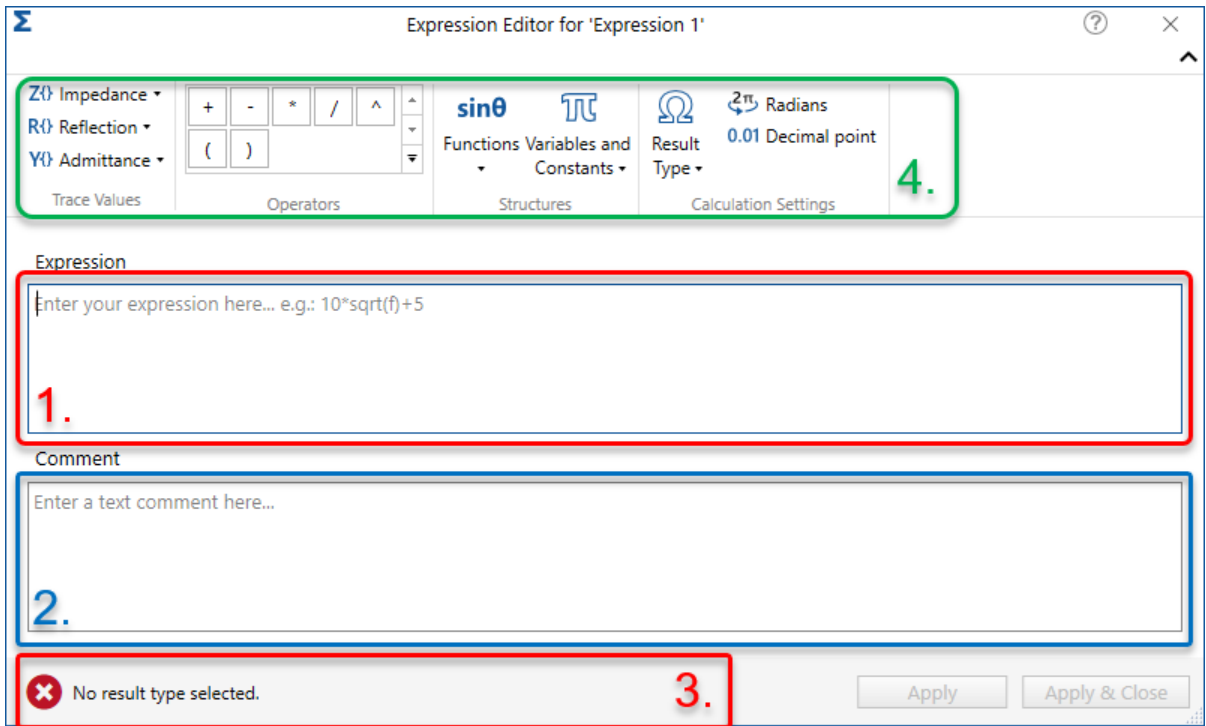



Figure 11-12: Expression editor window

The Expression editor window is structured into four main regions:

1. **Expression field**- Here you can enter your mathematical expression to be evaluated.
2. **Comment field** - In this field you can enter a text note for documentation purpose. You could for example describe the expression you have entered.
3. **Status bar** - See if your expression has been successfully evaluated or if an error appears. If the evaluation is successful, you will see a green checkmark icon . If there is an error, the following icon will be shown: .
4. **Expression toolbar** - Here, you can find the available variables, operators, constants and settings you can use in the expressions.

### Enter an Expression

To enter an expression, you must at least:

1. **Enter** the **expression** in the expression field
2. Select the right **result type**
3. Click **Apply & Close**

In the following, you can find an overview on the functions of the expression toolbar:

### Trace Values

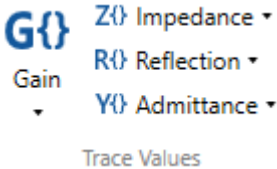

Depending on the available measurement traces and memory traces, you can select the trace data as input for your expressions. To use for example the impedance data of the measurement, you can select Impedance → Z{Measurement}. If you want to use the Gain data of the Memory 1 trace, enter: G{Memory 1}.

### Operators



The expression editor supports several **operators**. The most common ones are available for selection as shown in the image to the left.

### Functions, Variables & Constants

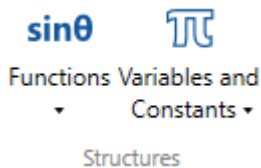

The following **functions** are available via the menu:

- General functions: log()...natural logarithm, log10()...10-base logarithm, sqrt()...square root
- Complex functions: abs()...magnitude, real()...real part of a complex number, imag()...imaginary part of a complex number, arg()...angle of a complex in radian, conj()...conjugate of a complex number
- Trigonometric functions: sin(), cos(), tan(), arcsin(), arccos(), arctan()

The following **variables & constants** are available via the menu:

- Variables: f...frequency in Hz, w...angular frequency in rad/s, j...imaginary number, s...complex frequency (jw), Z0...nominal impedance as set in BAS
- Constants: pi...π (3.141...), e...Euler's number, u0...permeability of free space, e0...permittivity of free space, c...speed of light

### Result Type

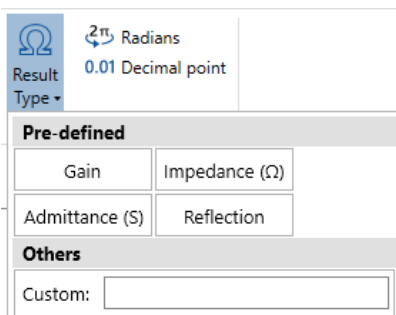

A **Result Type** for the expression result must be selected before the expression can be evaluated. This is required for the correct display of the expression results since no automatic unit-calculation is included in the expression parser.

The result type can be chosen from one of the pre-defined result types Impedance, Admittance, Reflection, Gain or a custom result type can be selected. When selecting custom, the unit can be entered in the text field or left empty for a unit-less value.

## Radius and Decimal point

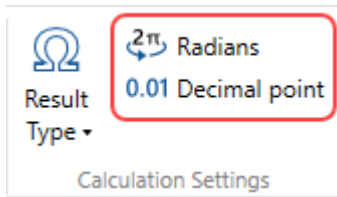

Please consider:

- The **angle** unit is always **radian**
- The radix character is always a **decimal point**. For example 2.5 equals two and a half.

## Expression field

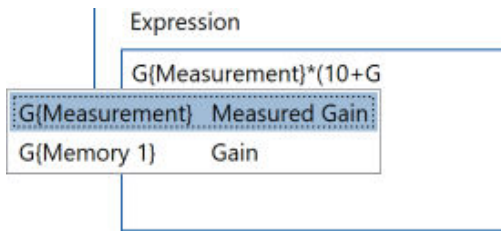

The expression is entered in the expression field. Operands and operators can be selected from the ribbon elements or directly entered in the expression field.

A Search function will show the available elements during typing.

## Apply & Close

After an expression has been successfully parsed , the expression can be applied using one of the two buttons at the lower right-hand corner:

- **Apply** will calculate the results values without closing the editor window.
- **Apply & Close** will calculate the result values & close the editor window.

In both cases the resulting expression curve is shown in the corresponding chart in the *Bode Analyzer Suite* main window.

## Expression trace configuration

The **Expression trace** and its chart view can be configured using the trace configuration box. The **Expression trace**, has the following specific options:

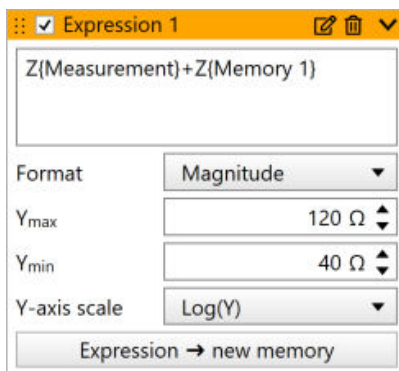

The expression entered in the editor is shown in the Expression field.

The result of an Expression trace can be copied to a Memory trace using the button

**Expression → new memory**

The editor window can be opened again by clicking the pen icon  or by clicking into the expression field.

If the frequency points of the used operands differ, an info icon will be shown in the trace header . Either linear interpolation will be used to find the needed operand values or the values will be skipped.



## 11.6 Port extension

The Port extension feature allows you to mathematically move the reference plane of a reflection or impedance measurements. This can be useful if Open/Short/Load calibration cannot be performed directly at the point of connection of the DUT. There could be a short transmission line on a PCB but the Open/Short/Load calibration has been performed at the point of the cable-connector.

Port extension allows you to enter a physical length  $L$  and the propagation speed respectively the velocity factor  $VF$ . The velocity factor  $VF$  is the ratio between the speed of light  $c$  and the propagation speed of the signal on the transmission line / cable. It is a number between zero and one. The time needed for the signal to travel along that transmission line can then be calculated by:

$$T = \frac{L}{c \cdot VF}$$

Assuming zero loss, the reflection factor at the end of that transmission line can be calculated as:

$$\Gamma_{\text{shift}} = \Gamma \cdot e^{j2\omega T}$$

### Using port extension

To use Port extension the first time, you must enable it in the Options dialog. You can find the option in the [options menu](#) under the **Advanced** section.

After having Port extension enabled, you will find the Port extension icon in the Home ribbon besides the calibration icons.

You can enable or disable Port extension by clicking on the icon. A green icon indicates that the Port extension calculation is active.

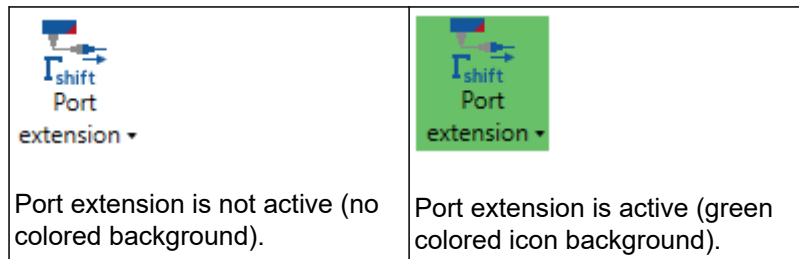

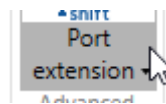
By clicking on the lower part of the icon  you can open the port extension configuration window. To do so, click on configure port extension as shown below.

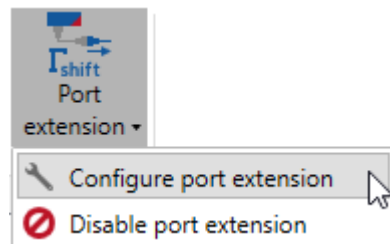

In the Port extension configuration window you can enter the physical length as well as the velocity

Cable Loss

> Use cable loss table

factor or the time delay directly. By clicking on the arrow besides Cable Loss, a table appears that allows to enter loss over frequency in dB per 100 m. In the example below, a 10 mm long RG58 cable shall be compensated. The physical length as well as the velocity factor and the cable loss are entered.

Port extension configuration

Velocity factor: 0,66

Physical length: 10 mm

Time delay: 50,54 ps

Cable Loss

Use cable loss table for calculation: No  Yes

Please enter the cable loss in dB/100m.

Frequency	Loss (per 100m)	
1 MHz	1,2 dB	
10 MHz	4,3 dB	
50 MHz	10,1 dB	
-	-	

Close

## 11.7 Cursor calculations

*Bode Analyzer Suite* allows you to perform the following calculations / evaluations based on cursors:

- Non-Invasive Stability Measurement based on output impedance (basic & advanced)
- Resonance-Frequency and Q measurement based on the shape of a resonance peak
- Stability margin calculation based on a loop-gain measurement (bode-plot)

### 11.7.1 Non-Invasive Stability Measurement

Non-Invasive-Stability-Measurement (NISM) is a method to determine the phase margin of a voltage regulator via the closed-loop output impedance. The advantage of this method is that only the output of the power supply needs to be accessed and no control loop needs to be broken.

*Bode Analyzer Suite* offers the following two NISM calculations:

1. Basic phase margin calculation (one-cursor)
2. Advanced phase margin calculation (two-cursors)

NISM is based on the fact that the phase response is very sensitive to the quality factor of a resonator. Assuming a second-order closed loop feedback system, the quality factor of the output impedance resonance peak is directly related to the phase margin of the control loop according to equation (9.25) in "Fundamentals of Power Electronics" by Robert W. Erickson and Dragan Maksimovic.

$$Q = \sqrt{\frac{\cos \varphi_m}{\sin \varphi_m}}$$

#### Basic phase margin calculation (one-cursor)

To measure the phase margin of a voltage regulator, you first need to measure the output impedance over frequency. Then go to the cursor ribbon and select the Basic phase margin calculation method as shown below:

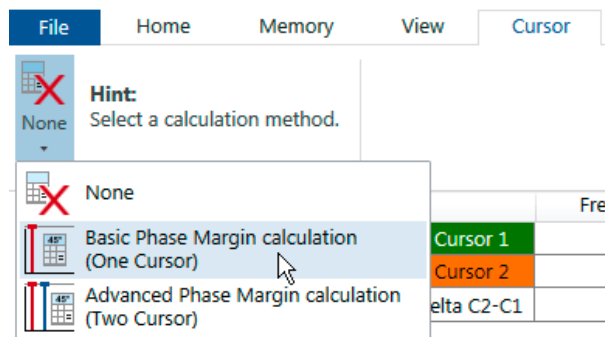

As a next step, follow the instruction in the GUI and place Cursor 1 to the peak in the Q(Tg) result. The phase margin calculation method shows the phase margin result in the cursor ribbon as shown in the following figure:

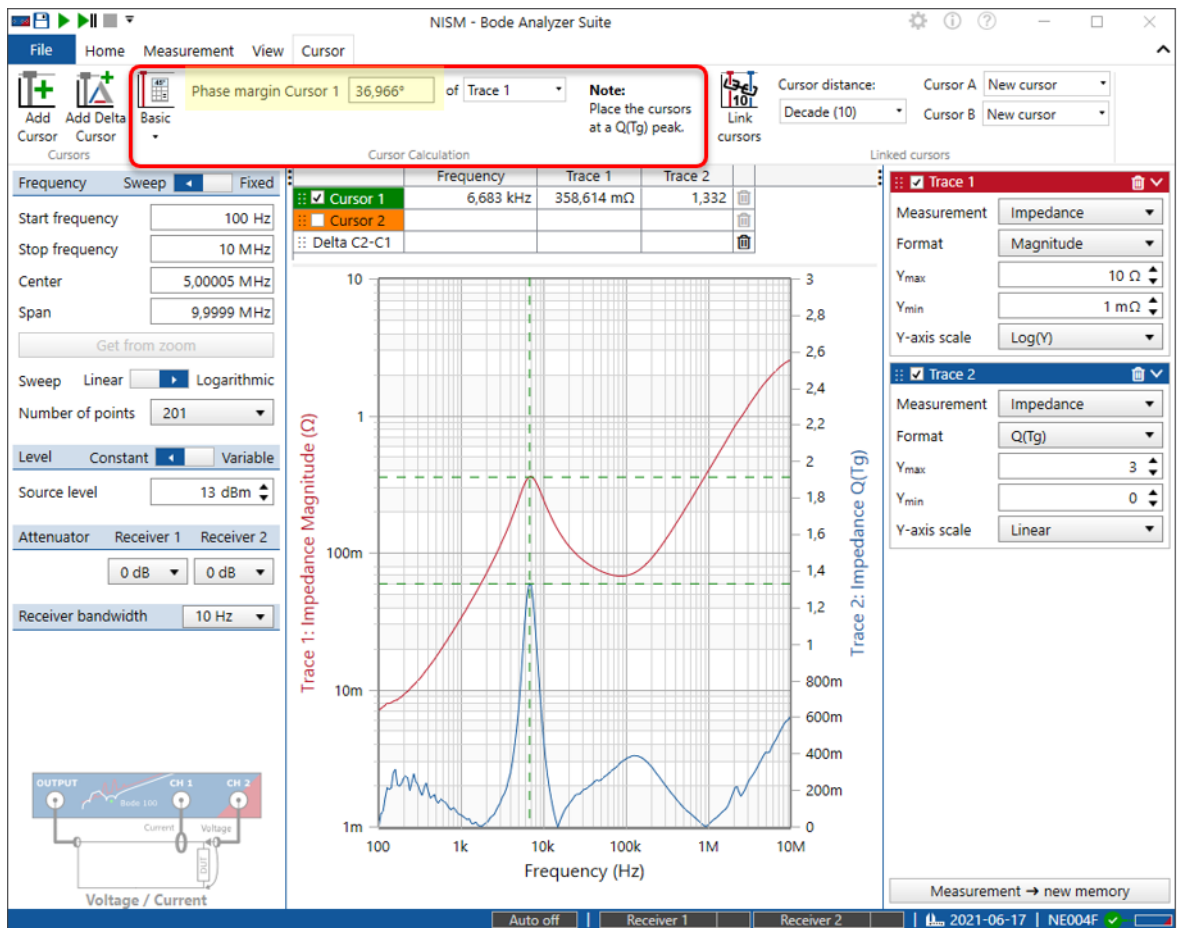

Figure 11-13: Basic phase margin calculation on output impedance of a linear regulator

The result shows a phase margin of nearly  $37^\circ$  (yellow) after placing cursor 1 to the peak in  $Q(Tg)$ .

### Advanced phase margin calculation (two cursors)

The advanced phase margin calculation uses a proprietary method developed by Steven Sandler (Picotest.com). The advantage of the advanced phase margin measurement method is that it includes the output filter damping factor and therefore generates more accurate results for highly damped systems.

If you measure output impedance of a regulator with low  $Q$  respectively high phase margin, the peak of  $Q(Tg)$  and the peak in impedance are not at the same frequency anymore. The higher the phase margin, the higher the distance between the impedance peak and the  $Q(Tg)$  peak.

The advanced phase margin calculation uses two cursors that need to be placed on both peaks in order to give a more accurate result for high phase margin values. To do so, select Advanced Phase margin calculation and place Cursor 1 at the peak in the  $Q(Tg)$  curve and Cursor 2 at the peak of the impedance magnitude curve.



To learn more about the non-invasive-stability measurement, please refer to the corresponding application note available at [www.omicron-lab.com/BodeManualAppNotes](http://www.omicron-lab.com/BodeManualAppNotes).

### 11.7.2 Fres-Q Calculation

For a fast and easy contactless measurement of the resonance frequency (Fres) and quality factor (Q) of RFID and NFC transponders *Bode Analyzer Suite* includes the Fres-Q cursor calculation. By automatically placing three cursors to the resonance peak, *Bode Analyzer Suite* automatically calculates the resonance frequency and quality factor based on the shape of the resonance curve.

Fres-Q calculation works as follows: *Cursor 2* is placed to the maximum y-value the curve which must correspond to the resonance peak. *Cursor 1* is placed to half the y-value at a lower frequency. *Cursor 3* is placed to half the y-value at higher frequency.

The *Cursor 2* frequency then equals the resonance frequency  $f_{res}$ .

The distance between *Cursor 1* and *Cursor 3* equals the bandwidth B.

The quality factor Q is then calculated by:

$$Q = \frac{f_{res}}{B}$$

To measure the resonance frequency and Q-factor of a resonance curve, go to the **cursor ribbon** and select the Fres-Q calculation method as shown below:

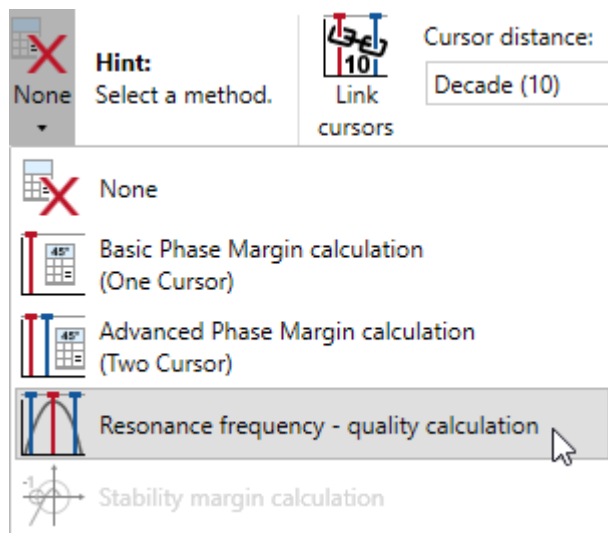

As a next step, select the format (Real, Magnitude or Phase) and trace you want to use for the cursor calculation from the ribbon interface as shown in the example below:

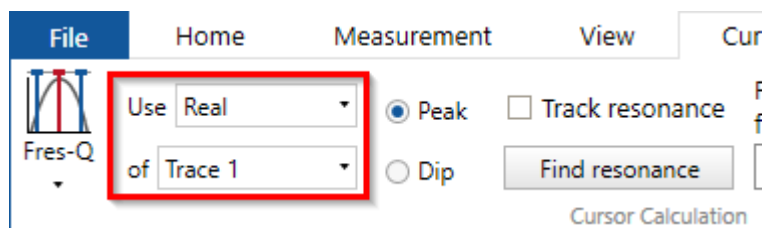

In this example we want to calculate the resonance frequency and Q-factor based on the Real part of the values in Trace 1. As an alternative also the Magnitude or Phase can be used. If multiple traces contain values or if a memory is linked to the cursor table, then the calculation can also be applied to these curves.

To start the calculation, click either on the button **Find resonance** or activate the checkbox  **Track resonance**. Track resonance will automatically evaluate the calculation and search the resonance peak after each completed sweep. As a result you should see the three cursor positioned correctly at the resonance curve and the result in the ribbon:

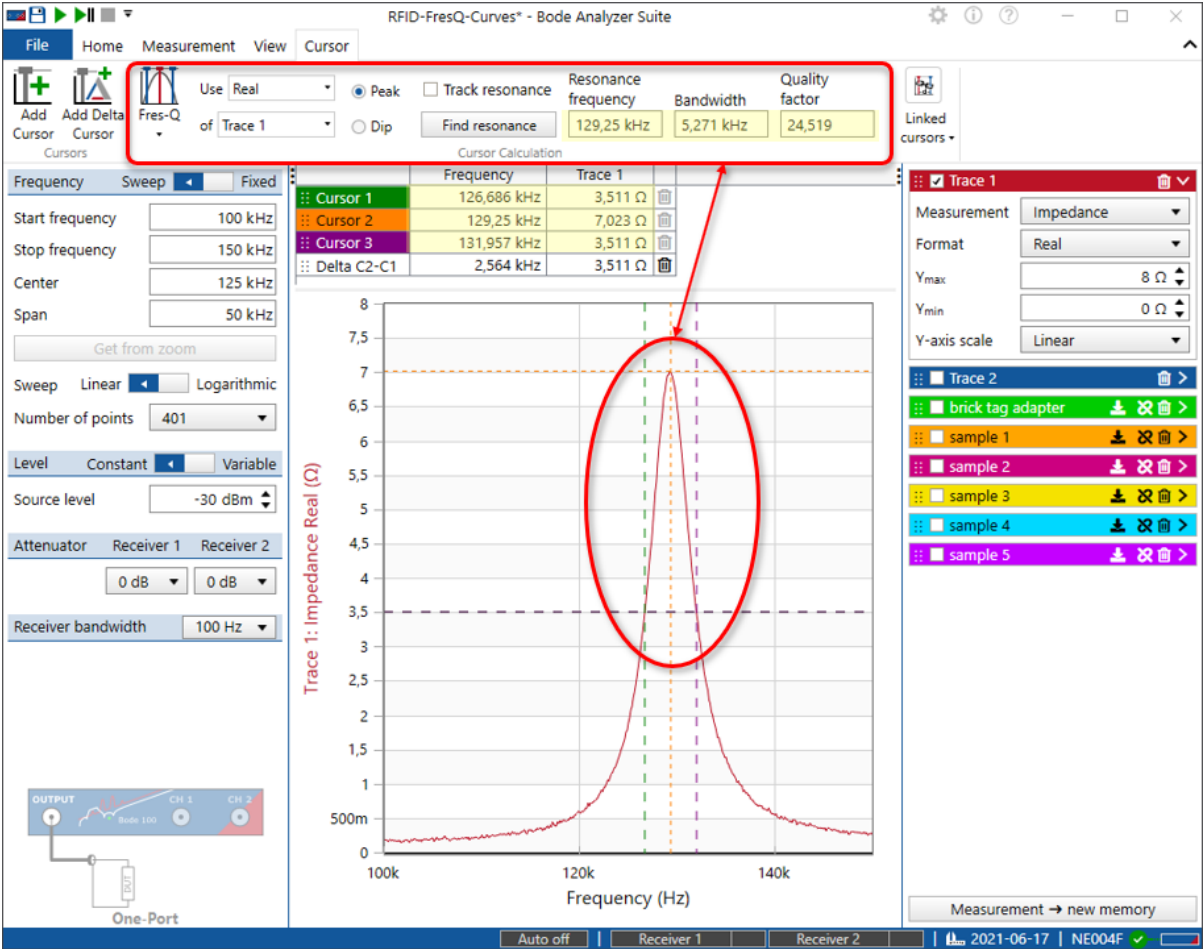

Figure 11-14: Contactless resonance frequency and q-factor measurement of a 125 kHz RFID tag. The result in this example indicates a resonance frequency of 129.25 kHz and a Q-factor of 24.5.

**i** To learn more about contactless resonance frequency and Q-factor measurements of RFID transponders, please refer to the corresponding application note available at [www.omicron-lab.com/BodeManualAppNotes](http://www.omicron-lab.com/BodeManualAppNotes).

### 11.7.3 Stability margin calculation

To get quicker stability margin results, *Bode Analyzer Suite* can automatically determine *Phase Margin*, *Gain Margin* & *Vector Stability Margin* using the Stability margin cursor calculation.

To activate stability margin calculation, go to the **cursor ribbon** and select the stability margin calculation method as shown below:

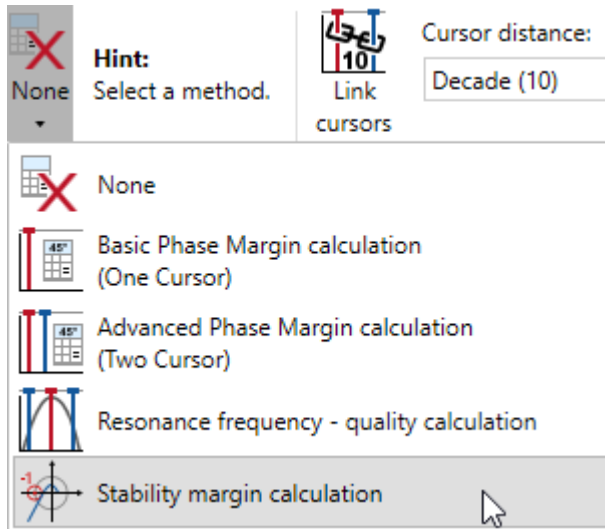

As a next step, select the trace you want to use to derive the stability margin information from. If you want to calculate stability margin from a memory trace, please link the cursor to the memory using the link cursor icon  in the memory trace. In the following example we want to calculate the stability margin of the measurement curve in Trace 1:

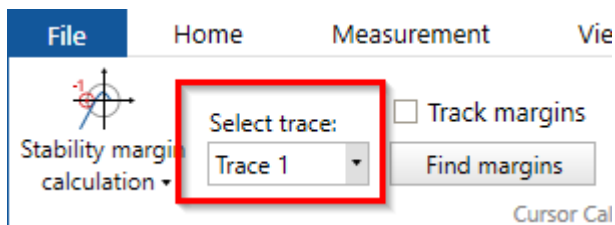

To start the calculation, click either on the button  or activate the checkbox  **Track margins**. Track margin will automatically search the stability margins after each completed sweep.

As a result you can see the three cursor positioned at the frequencies of Phase margin, Gain margin and Stability margin. The results are shown in the cursor table and in the cursor ribbon:

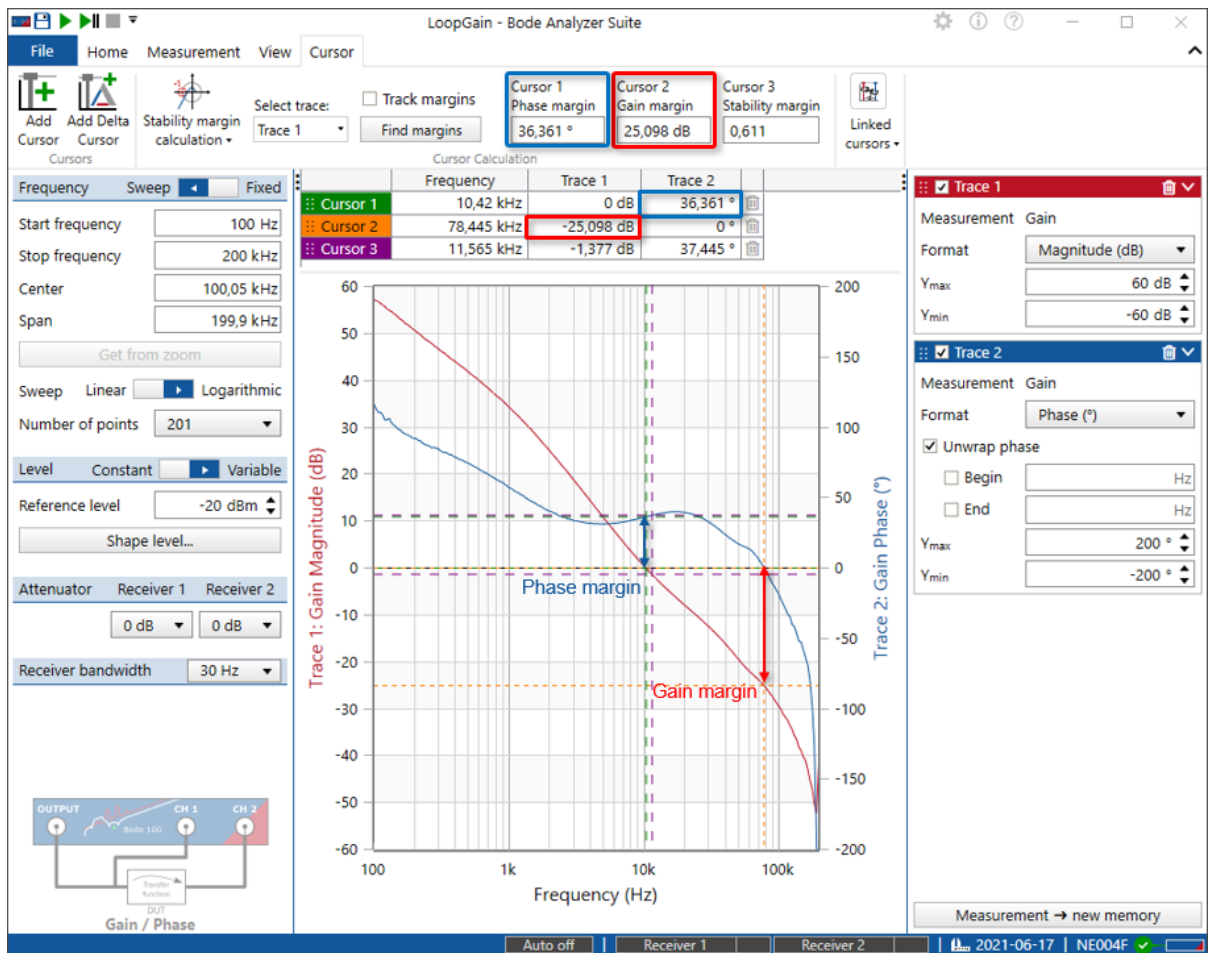

Figure 11-15: Stability margins displayed in the loop gain bode plot of a step-down dc/dc converter. Besides the Bode diagram, the stability margins are clearly visible in the Nyquist diagram. See next page.



## Nyquist Diagram

The stability margins can easily be seen in the Nyquist chart. Set Trace Format to Nyquist to display the Nyquist chart.

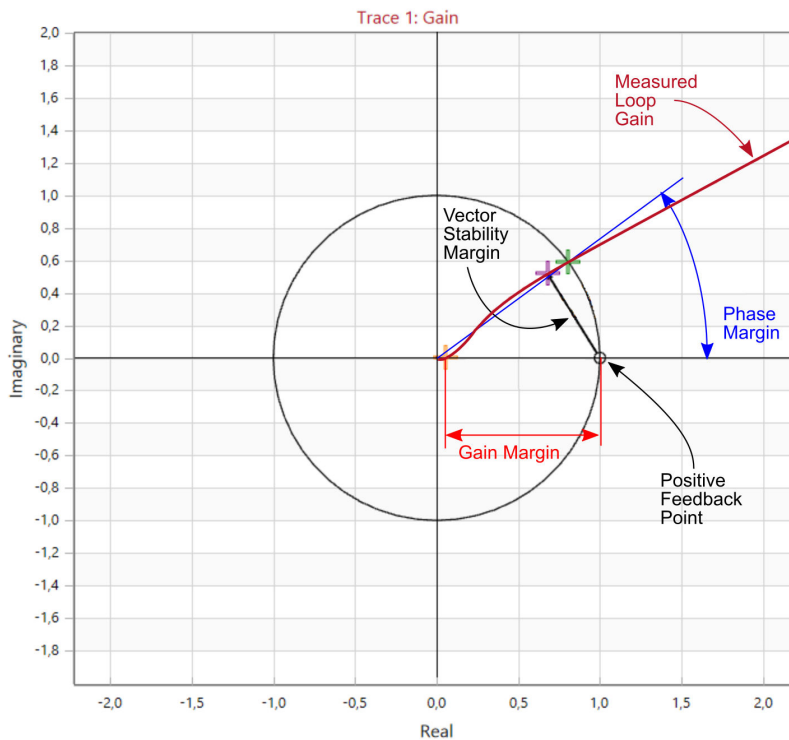

Figure 11-16: Stability margins displayed in the Nyquist chart. Note that the "instability point" is marked at +1.



When measuring loop gain of a negative feedback system using the voltage injection method,  $0^\circ$  measured phase indicates positive feedback. The reason is that the measured signal generally also travels thru the inverting error amplifier, getting an additional  $180^\circ$  phase shift. This is why the instability point is displayed at +1. If you have a case, where the instability point should be at -1, Go to the **Measurement** ribbon and set **Instability Point** to -1.

To learn more about loop gain measurements and stability margin measurements, please check out our webpage: [www.omicron-lab.com/BodeManualAppNotes](http://www.omicron-lab.com/BodeManualAppNotes).

## 11.8 Averaging

Bode Analyzer Suite offers **averaging** to **reduce** measurement **noise**.

Averaging can be activated by clicking on the Average measurement icon  in the **View** ribbon. When averaging is active, the icon turns green.

The **average factor** influences the averaging method. A **higher** average **factor** offers a **higher noise reduction** but requires more sweeps to complete.

The following figure shows an example where a Gain measurement is averaged (Green icon) and 4 sweeps have already been completed. The average factor is set to 10. Six more sweeps should be completed to achieve the full noise reduction in this case.

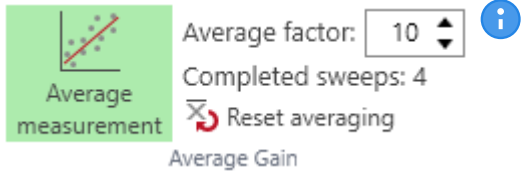

Average factor:  

Completed sweeps: 4

 Reset averaging

Average Gain

You can **increase** or **decrease** the **average factor** during averaging without losing previous measurements.

The following equation shows the implemented averaging algorithm:

$$\bar{x}_n = \frac{x_n}{N} + \left( \bar{x}_{n-1} \cdot \frac{N-1}{N} \right)$$

The new averaged result is calculated using the new measured value and the previous averaged result. N is the average factor that must be  $\geq 2$ .

 The influence of an old measurement will become lower and lower but will never completely disappear (exponentially decaying moving average).

If your measurement result has changed, you can use Reset averaging  to restart the averaging and remove the influence of previous measurement results.

Averaging is performed sweep to sweep. This means that at least 2 sweeps are necessary to calculate an averaged result.

Averaging is calculated using the complex measurement result.

 Averaging needs to be activated for **Gain** and **Impedance** measurements **separately!**

### Memory traces

Whenever you activate averaging, two memory buttons are available to copy data to the memory traces.

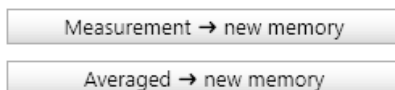

**Measurement** → **new memory** will copy the measured result to a new memory trace.

**Average** → **new memory** will copy the averaged result to a new memory trace.

## 11.9 Unwrapped phase

The Phase shift between two sine-waves can only be measured between  $-180^\circ$  and  $+180^\circ$  respectively  $-\pi$  and  $+\pi$  in radians. If the phase shift of a DUT exceeds  $-180^\circ$  or  $+180^\circ$ , this fact causes a strange-looking phase jump in the diagram.

The following figure shows the Gain and Phase curve of the IF filter DUT delivered with *Bode 100*:

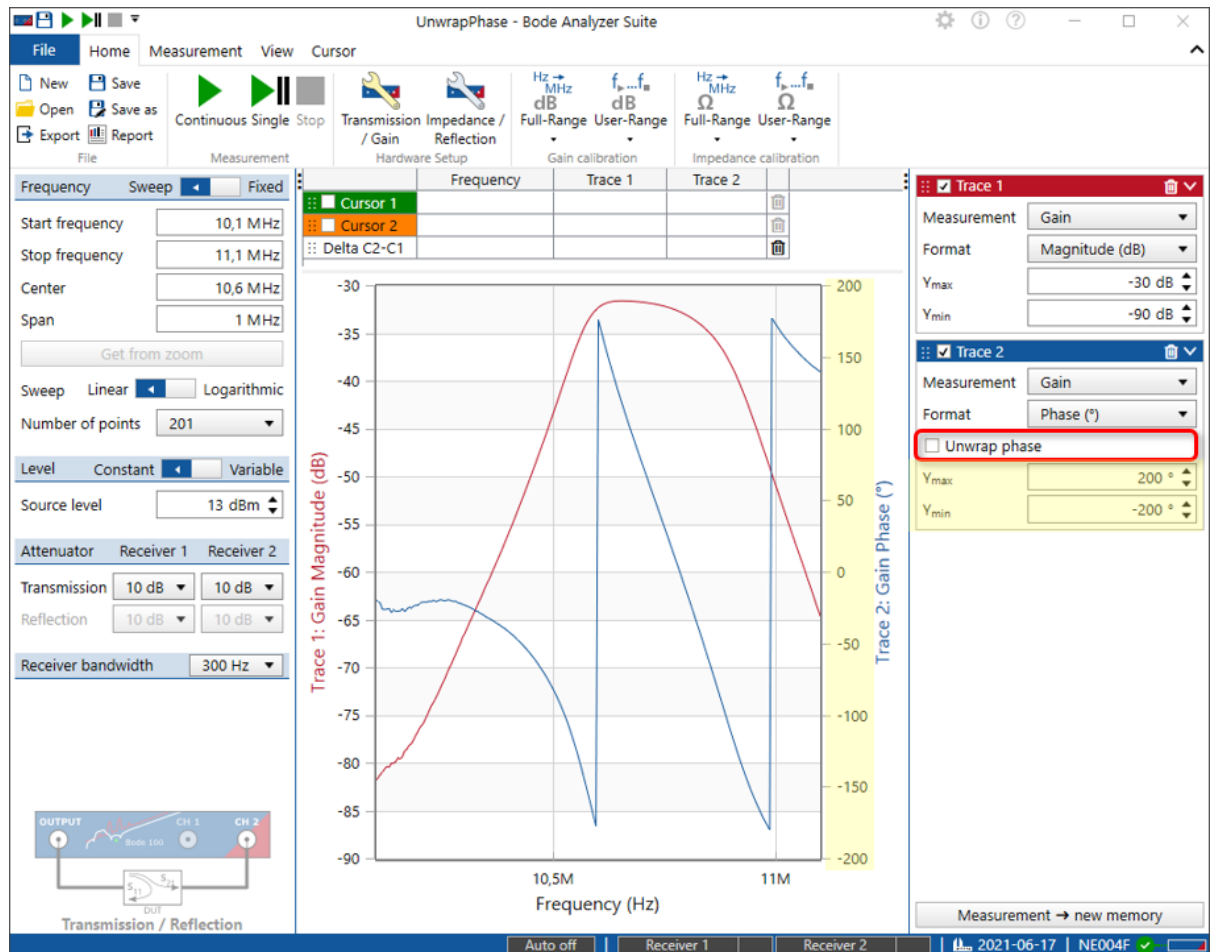

Figure 11-17: Phase-wrap effect caused by the fact that phase can only be measured between  $-180^\circ$  and  $+180^\circ$

In some applications, such as the measurement of the total phase shift of a filter, it is useful to continuously display the phase. To do so, activate the Unwrap phase function by clicking the **Unwrap phase** checkbox in the Trace configuration box. This leads to an continuous phase display as shown below:

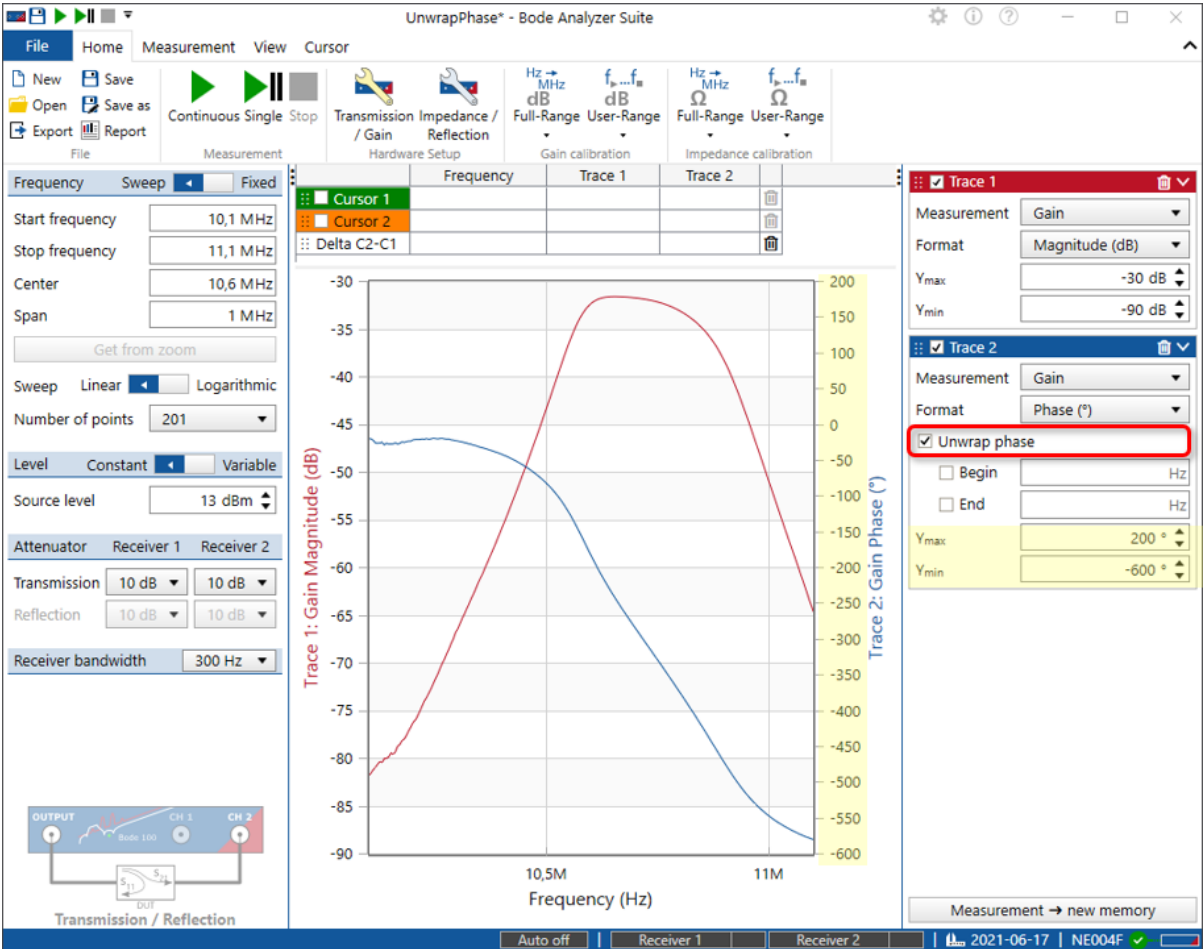

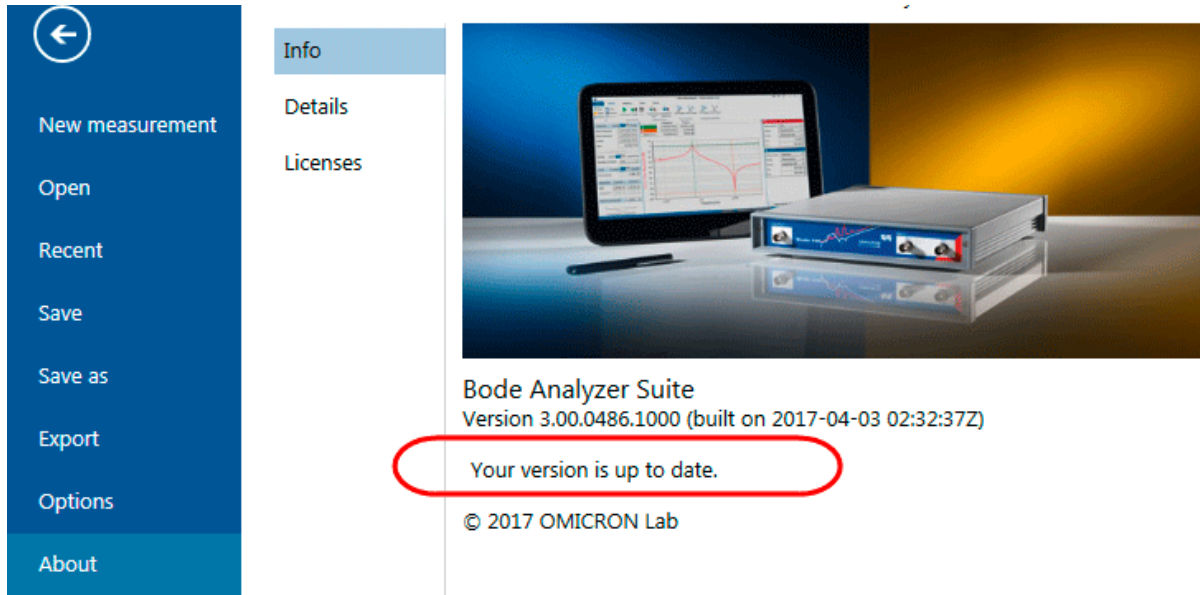

Figure 11-18: Unwrapped phase result shows the total phase shift of the IF filter DUT

**Hint:** Optionally you can limit the unwrapping to a specific frequency range. Use the Begin and End check boxes and corresponding entry fields to define a frequency range in that the phase shall be unwrapped. This is especially useful when the phase result contains a lot of noise in a specific frequency range.

## 11.10 Check for updates

In order to check if your *Bode Analyzer Suite* is up to date, click on the info icon . This will enter the info pane and check for available updates. If your version is up to date, this will be indicated as shown below:



-  If a newer version is available, the *Bode Analyzer Suite* will inform you by showing an information screen.

## 12 Automating measurements

Besides using the *Bode Analyzer Suite*, the *Bode 100* can also be controlled via the Automation Interface, a software command interface or API (Application Programmer's Interface). The Automation Interface can either be accessed via the COM interface or directly from .NET. For details, please refer to the Automation Interface reference at: [www.omicron-lab.com/BodeAutomationInterfaceHelp](http://www.omicron-lab.com/BodeAutomationInterfaceHelp)

In addition a LabVIEW instrument driver is available to control the *Bode 100*.

Starting with *Bode Analyzer Suite 3.25* an experimental SCPI (Standard Communication Protocol for Instrumentation) interface is available. The SCPI interface offers a raw-socket connection to control the *Bode 100*. Via SCPI similar functionality is offered as in the Automation Interface.

### Automation Interface (COM)

The *Automation Interface* is a software interface that allows to control *Bode 100* from many programming languages and applications such as C#, .NET, Python, Matlab, Excel using the Microsoft inter-process communication technology COM or native .NET access.

The Automation Interface 3.25 offers similar measurements like the *Bode Analyzer Suite*. The most important features of the Automation Interface 3.X are:

- Ability to control more than one *Bode 100* device from a single PC
- Fast repetitive measurements including sweep and single point measurements
- Pre-configured measurement modes similar to *Bode Analyzer Suite*
- Events to program real-time applications
- Fully compatible with 32 bit and 64 bit Windows systems

### NuGet package

If you are a .NET developer, you might be interested in using the Automation Interface in form of the NuGet package **OmicronLab.VectorNetworkAnalysis.AutomationInterface**.

### LabVIEW Instrument Driver

In addition to the COM based Automation Interface a LabVIEW instrument driver is available for the *Bode 100*. Please use the latest driver 3.25 or newer. The driver is available from [www.ni.com](http://www.ni.com).

 In any case the installation of the USB driver for the *Bode 100* device is required. The simplest way to do so is to install the *Bode Analyzer Suite*.

### SCPI Interface



The current SCPI interface is an experimental first version offering similar functions as the Automation Interface. For more information on the SCPI function, please refer to [www.omicron-lab.com/BodeAutomationInterfaceHelp](http://www.omicron-lab.com/BodeAutomationInterfaceHelp). Using SCPI offers the possibility to control the *Bode 100* from e.g. Linux without the need to use .NET or COM. For more information on that, please contact us (see: [Support](#)).

 No GUI functions are included in the SCPI interface. Only the raw measurement data can be accessed. Only single Channel and single Trace measurements are possible.

# 13 Troubleshooting

## Connection issues

In case you are not able to start a measurement with *Bode 100*, please check the following points:

1. Check if the green power LED at the front panel is on.  
In case that the LED is not lit execute the following steps:
  - a. Check if the Wide-range AC power supply is plugged correctly into the mains socket.
  - b. Check if the DC connector of the power supply is properly plugged into the *Bode 100*.
  - c. Check the output voltage of the DC connector with a volt-meter.
  
2. Check if the communication between the *Bode Analyzer Suite* and the *Bode 100* has been successfully established. To do so, check if the serial number of your *Bode 100* is displayed in the start screen (see figure7-1 on page 19, or the right bottom corner of the main window  (see figure7-2 on page 20). In case you cannot see any *Bode 100* serial number, please execute the steps below:
  - a. Check if the USB cable is properly plugged into the computer and the *Bode 100*.
  - b. Try disconnecting and re-connecting the USB cable.
  - c. If this does not help, avoid USB hubs and plug *Bode 100* directly into an USB port of your computer.
  - d. Try to connect *Bode 100* to a different USB port or a different computer. Some USB 3 ports cause issues with *Bode 100* Revision 1 devices. Especially with AMD Ryzen processors, the older *Bode 100* Revision 1 devices don't work. If you face this issue, please contact the [OMICRON Lab Support](#)
  - e. Move the mouse over the icon  in the status bar and then click .

## Software problems

In case you run into software issues such as crashes or unexpected behavior, please contact the [OMICRON Lab Support](#).

To help the support team, you can include the log file of the *Bode Analyzer Suite* in your support request. The log file is normally located at: `C:\ProgramData\OMICRON Lab\Bode Analyzer\Logs\Bode Analyzer Suite.log`.

-  In case you are still experiencing problems do not hesitate to contact us. We are looking forward to support you. Check out the following [Support](#) section for further information on how to contact us.

# Support

When you are working with our products we want to provide you with the greatest possible benefits. If you need any support, we are here to assist you!

## Technical Support - Get Support



[www.omicron-lab.com/support](http://www.omicron-lab.com/support)

[support@omicron-lab.com](mailto:support@omicron-lab.com)

At our technical support hotline, you can reach well-educated technicians for all of your questions. Competent and free of charge.

Make use of our technical support hotlines:

**Americas:** +1 713 830-4660 or +1 800-OMICRON

**Asia-Pacific:** +852 3767 5500

**Europe / Middle East / Africa:** +43 59495

Additionally, you can find the OMICRON Lab Service Center or Sales Partner closest to you at [www.omicron-lab.com](http://www.omicron-lab.com) → Contact.

OMICRON Lab  
OMICRON electronics GmbH, Oberes Ried 1, 6833 Klaus, Austria. +43 59495.



# Index

.bode file .....	109
.bode3 file .....	109
.bodex file .....	109
.mcalx .....	108

## A

Absolute maximum ratings .....	12
Accessories .....	11
Address (OMICRON address) .....	156
API .....	154
Applications .....	36
Attenuator .....	78
Auto axis placement .....	117
Auto optimize .....	122
Automated measurements .....	154
Automation .....	72
Automation Interface .....	154
Auto-scale .....	122
Average .....	150
Averaging .....	150
Axis .....	117
Axis scaling .....	122

## B

Block diagram .....	17
B-SMC .....	61
B-WIC .....	61

## C

Calibration .....	85, 106
Full-Range .....	85
User-Range .....	85
Calibration .....	85, 94, 96, 98, 100, 102, 105, 106
Chart	
Context menu .....	30
Chart .....	117
Cleaning .....	8
Compensation .....	85
Compliance	
CE .....	9
EMC .....	9
RoHS .....	9
Connectors .....	15
Contact information (OMICRON address) .....	156
Context menu .....	30
Continuous phase .....	151
Copy chart image .....	109
Copy measurement data .....	109
Copy to clipboard .....	109
Correction .....	85
CSV .....	113
Cursor calculations .....	143

Cursors .....	125
Cursor table .....	125
Find maximum .....	125
Find minimum .....	125
Find zero .....	125
Linking .....	125
Search maximum .....	125
Search minimum .....	125
Search zero .....	125
Track maximum .....	125
Track minimum .....	125
Track zero .....	125
Tracking .....	125

## D

Data / Memory .....	134
Deletion of calibration .....	107
Delivered Items .....	10
Disposal .....	9

## E

Email (OMICRON Lab email address) .....	156
Examples .....	19
Excel .....	113
Export calibration data .....	108
Expression trace .....	134
External Bridge .....	71
External coupler .....	51
External probes .....	83

## F

Factory calibration .....	85
Features .....	109
Fres-Q .....	145
Full-Range .....	85
Full-Range .....	103, 105, 106
Function principle .....	18

## G

Gain Calibration .....	86
Gain Margin .....	147
Gain/Phase .....	50
Generator level .....	80
Get from zoom .....	119

## H

Hardware setup .....	74
Hotline .....	156

## I

Icons .....	26
Impedance Adapter .....	61, 98
Impedance Analysis	
Impedance Adapter .....	61
Shunt-Thru with series resistance .....	68

Impedance calibration .....	91
Impedance Measurement	
Result formats .....	37, 39
Impedance Analysis	
One-Port .....	52
Shunt-Thru .....	66
Import data .....	111
Input Level .....	78
Internal device calibration .....	85
Internal path compensation .....	85

## L

LabVIEW .....	154
Level unit .....	80
Linux .....	154
Loop Gain .....	50

## M

Marker .....	125
Math trace .....	134
Matlab .....	154
Measurement configuration .....	22
Measurement modes .....	36
External coupler .....	51
External Bridge .....	71
Gain/Phase .....	50
Impedance Adapter .....	61
One-Port .....	52
Series-Thru .....	69
Shunt-Thru .....	66
Shunt-Thru with series resistance .....	68
Transmission / Reflection .....	44
Voltage/Current .....	70
Measurement trace .....	134
Memory curves .....	130
Memory traces .....	130

## N

NISM .....	143
Noise reduction .....	150
Noise Rejection .....	76
Non-Invasive Stability Measurement .....	143
Nyquist .....	147

## O

One axis per chart .....	117
One-Port .....	52, 94
Open/Short/Load .....	91
Optimize .....	122
Optimize .....	117
Options	
Chart general .....	31
Chart memory .....	31
Clipboard .....	31
Export .....	31
General .....	31
Report .....	31
Options menu .....	31
Output level .....	80
Overload .....	78

## P

Paste from clipboard .....	111
PC	
Operating System .....	14
System requirements .....	14
PDF .....	116
Phase jumps .....	151
Phase Margin .....	147
Port Extension .....	141
Print report .....	116
Probe factor .....	83
Probes .....	83

## Q

Quality factor .....	145
----------------------	-----

## R

Receiver Bandwidth .....	76
Recycling .....	9
Reflection .....	94
Report templates .....	116
Resolution Bandwidth .....	76
Resonance-Frequency .....	145
Result formats .....	37, 39

## S

S21 calibration .....	88
SAFETY	
Designated use .....	8
Operator qualifications .....	7
Rules for use .....	7
Safety instructions .....	7
Saving calibration data .....	107
Saving measurement data .....	109
Scaling .....	117
SCPI .....	72, 154
Series-Thru .....	69, 100
Shaped level .....	80
Shunt-Thru .....	66, 100
Shunt-Thru with series resistance .....	68
Sideband Rejection .....	76
Signal / Noise .....	78
Skippy .....	72
Software introduction .....	19
Software update .....	153
Source .....	80
Specifications .....	13
Stability .....	147
Stability measurement .....	50
Status bar .....	29
Step-by-step examples .....	19
Support .....	156
System requirements .....	14

**T**

Technical Data .....	12
Absolute maximum ratings .....	12
Bode 100 specifications .....	13
Environmental Requirements .....	14
Mechanical data .....	14
System requirements .....	14
Temperature range .....	14
Technical support .....	156
Thru calibration .....	88, 89
Touchstone .....	115
Trace configuration .....	24, 134
Transmission / Reflection .....	44
Troubleshooting .....	155

**U**

Unwrap phase .....	151
Update informer .....	153
User-Range .....	85
User-Range .....	103, 105

**V**

Voltage/Current .....	70, 102
-----------------------	---------

**W**

Web (OMICRON Lab website) .....	156
Welcome screen .....	19
Window .....	20

**Z**

Zooming .....	119
---------------	-----

[info@omicron-lab.com](mailto:info@omicron-lab.com)  
[www.omicron-lab.com](http://www.omicron-lab.com)

Bode 100 User Manual English  
© OMICRON Lab, 2023

Version 12.0

ENU 1006 05 09