



**OMICRON
LAB**



Bode 100 User Manual



Smart Measurement Solutions

Bode 100

User Manual

Article Number VESD0661 - Manual Version: Bode100.AE.4

© OMICRON Lab 2010. All rights reserved.

This User Manual is a publication of OMICRON electronics GmbH.

This User Manual represents the technical status at the time of printing. The product information, specifications, and all technical data contained within this User Manual are not contractually binding. OMICRON electronics reserves the right to make changes at any time to the technology and/or configuration without announcement. OMICRON electronics is not to be held liable for statements and declarations given in this User Manual. The user is responsible for every application described in this User Manual and its results. OMICRON electronics explicitly exonerates itself from all liability for mistakes in this manual.

Please feel free to copy this manual for your needs.

Windows is a registered trademark of Microsoft Corporation. Excel is a registered trademark of Microsoft Corporation. Visual C++ is a registered trademark of Microsoft Corporation. MATLAB is a registered trademark of The MathWorks, Inc. LabVIEW is a registered trademark of National Instruments. OMICRON Lab and Smart Measurement Solutions are registered trademarks of OMICRON electronics GmbH.

Contents

	Using This Manual	7
	Conventions and Symbols Used	7
	Related Documents	7
1	Introduction	9
	1.1 Overview	9
	1.2 Block Diagram	11
	1.3 Connectors	12
	1.4 Standard Compliance	13
	1.5 Normative Conformity	13
	1.6 Test Compliance	13
	1.7 Delivery	14
	1.8 Additional Accessories	15
2	Getting Started	17
	2.1 Installing the <i>Bode Analyzer Suite</i>	17
	2.2 Powering the <i>Bode 100</i>	17
	2.3 Connecting the <i>Bode 100</i> to the Computer	17
	2.4 How to Proceed	18
3	Gain/Phase Mode	19
	3.1 Basics	22
	3.1.1 Internal Reference Connection	23
	3.1.2 External Reference Connection	23
	3.2 Choosing the Reference Connection	24
	3.3 Example: Gain/Phase Measurement	26
4	Impedance/Reflection Mode	35
	4.1 Basics	36
	4.1.1 General Formulas	36
	4.1.2 Equivalent Circuits	37
	4.1.3 Quality Factor	39

4.2	Example: Impedance/Reflection Measurement.	39
5	Frequency Sweep Mode	47
5.1	Example: Frequency Sweep Measurement.	52
5.2	Impedance Calibration.	62
6	Frequency Sweep (External Coupler) Mode	67
6.1	Example: Frequency Sweep (External Coupler) Measurement	69
7	Frequency Sweep (Impedance Adapter) Mode	79
7.1	Example: Frequency Sweep (Impedance Adapter) Measurement	80
8	Calibrating the <i>Bode 100</i>.	89
8.1	Calibration Methods.	89
8.1.1	Probe Calibration	89
8.1.2	User Calibration	90
8.1.3	Hierarchy of Calibration Methods	91
8.2	Calibration in the Gain/Phase Mode (Internal Reference Connection)	91
8.3	Calibration in the Gain/Phase Mode (External Reference Connection)	92
8.4	Calibration in the Impedance/Reflection Mode	97
8.5	Calibration in the Frequency Sweep Mode	105
8.6	Calibration in the Frequency Sweep (External Coupler) Mode	106
8.7	Calibration in the Frequency Sweep (Impedance Adapter) Mode.	110
9	Common Functions	117
9.1	Toolbars, Menus and Commands	117
9.2	Setting the Measurement Range.	120
9.3	Selecting the Measurement Speed	120
9.4	File Operations	121
9.4.1	Loading and Saving the Equipment Configuration	121
9.4.2	Exporting Measurement Data.	122
10	Advanced Functions	125
10.1	Advanced Display Options	125
10.1.1	Gain/Phase and Impedance/Reflection Mode	125
10.1.2	Frequency Sweep Modes	129

10.2	Advanced Sweep Options	140
10.3	Unwrapped Phase	144
10.4	Using the Trace Functions.	147
10.4.1	Average	149
10.4.2	Min Hold	153
10.4.3	Max Hold.	153
10.4.4	Setting the Process Depth to Infinity.	155
10.5	Y-Axis Scaling	156
10.6	RLC-Q Sweep	160
10.7	Level Shaping	164
10.8	Source Control.	169
10.9	Using Probes	171
11	Automation Interface	175
12	Troubleshooting.	179
12.1	USB Cable and/or Power Supply to the <i>Bode 100</i> Is Missing.	179
12.2	Lost Communication	179
12.3	Cannot Select Frequencies Lower Than 10 Hz.	179
13	Technical Data	181
13.1	<i>Bode 100</i> Specifications	181
13.2	Power Requirements.	182
13.3	Absolute Maximum Ratings.	182
13.4	System Requirements	183
13.5	Environmental Requirements	183
13.6	Mechanical Data	184
	Contact Information / Technical Support	185
	Index	187

Using This Manual

This User Manual provides detailed information on how to use all functions of the *Bode 100* vector network analyzer properly and efficiently. The *Bode 100* User Manual is intended for all users of the *Bode 100*, providing instructions on the operation, usage, and measurement procedures.

Any user of the *Bode 100* should have fundamental working knowledge of basic electronics, general measurement techniques, and the use of computer-based applications running under a Windows® environment.

Conventions and Symbols Used

In this manual, the following symbol indicates paragraphs with special safety relevant meaning:

Symbol	Description
	Equipment damage or loss of data possible

Related Documents

The following documents complete the information covered in the *Bode 100* User Manual:

Title	Description
Automation Interface Object Hierarchy and Automation Interface Reference (available in the <i>Automation</i> subdirectory of the <i>Bode Analyzer Suite</i> directory)	Provide detailed information on the <i>Bode Analyzer Automation Interface</i> .

This page intentionally left blank

1 Introduction

1.1 Overview

The *Bode 100* is a multifunctional test & measurement instrument designed for professionals such as scientists, engineers and teachers engaged in the field of electronics. Its concept – universal hardware controlled by the *Bode Analyzer Suite* software running on a computer – makes the *Bode 100* an efficient and flexible solution for a wide spectrum of applications including:

- **Gain/Phase** measurements
The *Bode 100* measures the gain and phase of passive and active electronic circuits as well as complex electronic systems such as closed-loop control systems, video systems and RF equipment.
- **Impedance/Reflection** measurements
The *Bode 100* measures the impedance, admittance and reflection coefficient of passive and active electronic circuits. An internal circuitry facilitates performing measurements by just connecting the device under test (DUT) to the *Bode 100* source.
- **Frequency Sweep** measurements
In addition to single frequency measurements, the *Bode 100* performs measurements in the **Frequency Sweep** mode.
In this measurement mode, the *Bode 100* is capable of measuring the complex gain, reflection coefficient and impedance of the DUT. The results are displayed as a function of the frequency in various display formats such as group delay curves or Smith charts.
- **Frequency Sweep (External Coupler)** measurements
In this measurement mode, you can measure the complex impedance, admittance and reflection coefficient of the DUT by using an external directional coupler or other external measurement bridge. Typical application examples include measurements of broadcast antennas and impedance measurements with signal levels above 20 mW.
- **Frequency Sweep (Impedance Adapter)** measurements
In this measurement mode, you can measure the impedance of wired components and surface mounted components by using the B-WIC and B-SMC impedance adapters (see 1.8 "Additional Accessories" on page 15) respectively.

The measurement results are available on your computer for processing and/or documentation.

The *Bode 100* includes a DDS (direct digital synthesis) signal source with adjustable level and frequency for excitation of the DUT, two receivers processing the DUT's response and a microcontroller. A DC power converter generates voltages for powering the circuitry involved. For the basic block diagram of the *Bode 100*, see Figure 1-1: "Block diagram" on page 11.

The *Bode Analyzer Suite* runs on a computer connected to the *Bode 100* through USB interface.

1.2 Block Diagram

Figure 1-1:
Block diagram

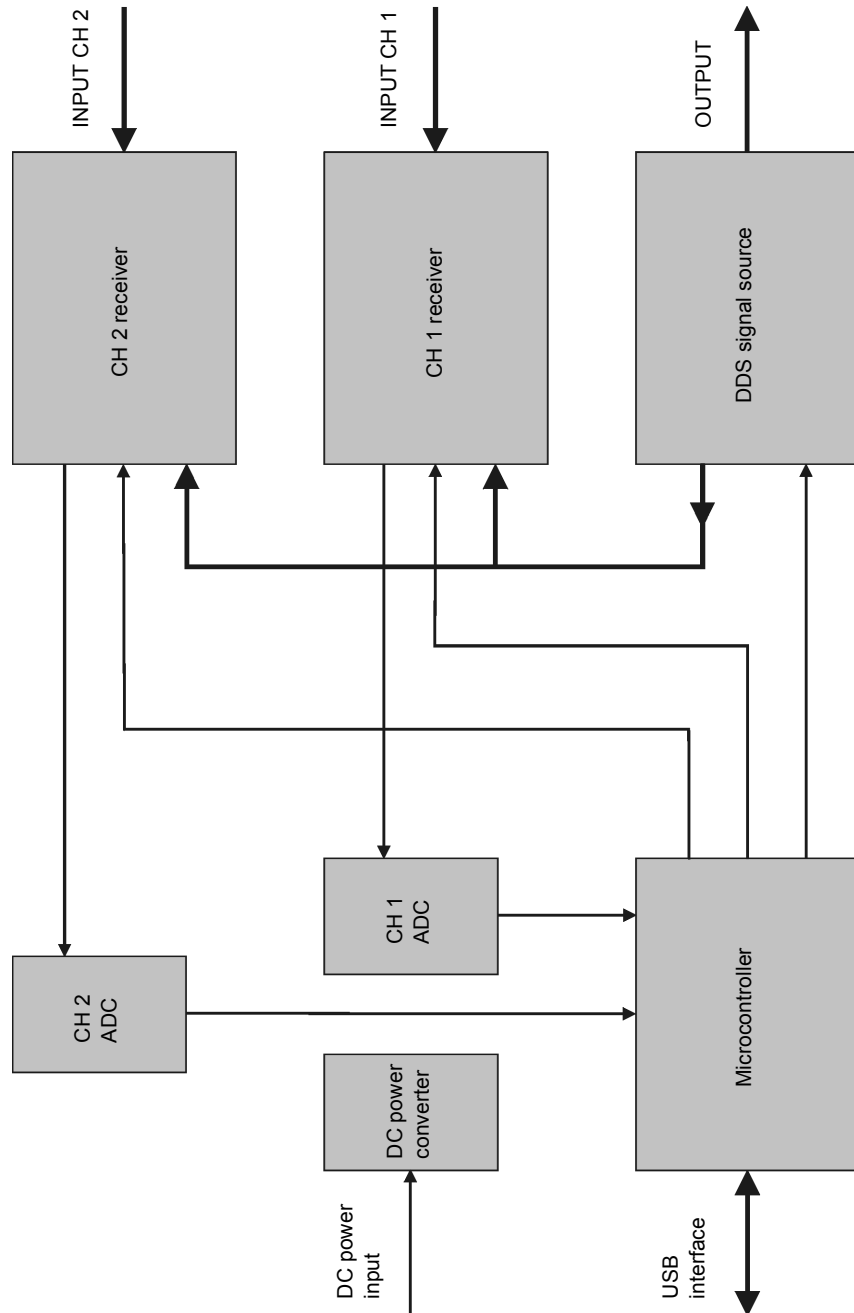

1.3 Connectors



Caution: To avoid damage of the *Bode 100*, check 13.3 "Absolute Maximum Ratings" on page 182 for maximum input signals at the INPUT CH 1 and INPUT CH 2 connectors and maximum reverse power at the OUTPUT connector.

The *Bode 100* provides the following connectors:

- OUTPUT (signal source output) on the front panel
- INPUT CH 1 (channel 1 input) on the front panel
- INPUT CH 2 (channel 2 input) on the front panel
- DC power input on the rear panel
- USB connector on the rear panel

Figure 1-2:
Bode 100 front view



Figure 1-3:
Bode 100 rear view



1.4 Standard Compliance

The *Bode 100* complies with the following standards:

Table 1-1:
Standard compliance

Standard	Description
EN/IEC 61326-1: Class B equipment Performance criterion B	EMC requirements
EN/IEC 61010-1	Safety requirements
Universal Serial Bus (USB) Specification, Revision 1.1 and Revision 2.0	USB interface

1.5 Normative Conformity

The *Bode 100* conforms to the following normative documents of the EU:

Table 1-2:
Conformity documents

Document	Description
LVD Directive 2006/95/EC	of the European Parliament and of the Council of 12 December 2006 on the harmonisation of the laws of Member States relating to electrical equipment designed for use within certain voltage limits (codified version)
EMC Directive 2004/108/EC	of the European parliament and of the council of 15 December 2004 on the approximation of the laws of the Member States relating to electromagnetic compatibility and repealing Directive 89/336/EEC

1.6 Test Compliance

The *Bode 100* passed the tests according to the EN/IEC 61010-1, IEC 61326.

1.7 Delivery

		
<p>Bode 100 multifunctional vector network analyzer</p>	<p>Bode 100 CD-ROM</p>	<p>Wide-range AC power supply including mains input plugs for different national standards</p>
		
<p>Test objects on a PCB: quartz filter, IF filter</p>	<p>USB cable</p>	<p>4 × BNC 50 Ω cable (m-m)</p>
		
<p>BNC straight adapter (f-f)</p>	<p>BNC T adapter (f-f-f)</p>	<p>BNC short circuit (m)</p>
		<p>The delivered items may differ slightly from the picture.</p>
<p>BNC 50 Ω load (m)</p>	<p>Bode 100 User Manual</p>	

1.8 Additional Accessories

The following additional accessories are available for purchase from OMICRON Lab.

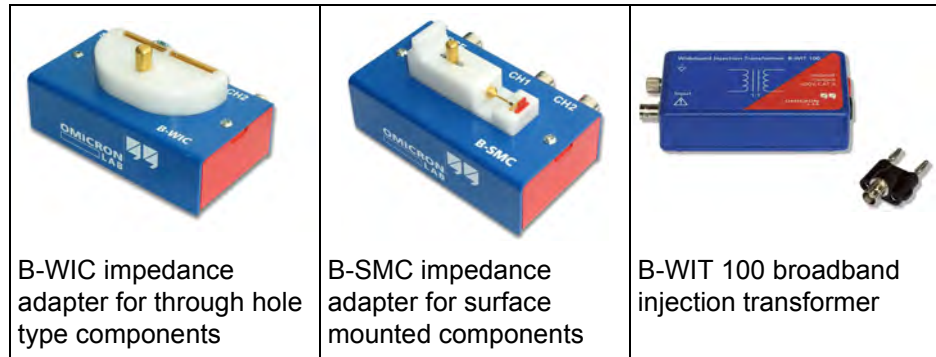

For information on using the B-WIC and B-SMC impedance adapters, see 7 "Frequency Sweep (Impedance Adapter) Mode" on page 79.

The B-WIT 100 broadband injection transformer is especially designated for measurement of switched mode power supplies and control loops. For more information on the possible applications of the B-WIT 100, refer to the OMICRON Lab Web site www.omicron-lab.com.

This page intentionally left blank

2 Getting Started



Caution: Before installing the *Bode 100*, check the environmental and power requirements (see 13 "Technical Data" on page 181).

2.1 Installing the *Bode Analyzer Suite*



Caution: Install the *Bode Analyzer Suite* from the delivered CD-ROM before connecting the *Bode 100* to the USB connector of your computer.

The *Bode Analyzer Suite* on the delivered CD-ROM controls the operation of the *Bode 100*. Install the *Bode Analyzer Suite* first, before you connect the *Bode 100* to the computer. Put the *Bode 100* CD-ROM in the CD-ROM drive and follow the instructions on the screen. Select the 32-bit or 64-bit installation according to your computer's hardware and operating system. For installation support, visit the OMICRON Lab Web site www.omicron-lab.com or contact your nearest support center (see "Contact Information / Technical Support" on page 185).

2.2 Powering the *Bode 100*



Caution: Before powering the *Bode 100* using a DC power supply different from the one delivered with the *Bode 100*, check the polarity of its output voltage (see 13.2 "Power Requirements" on page 182).

The *Bode 100* is powered with an external wide-range AC power adapter. Before powering the *Bode 100*, select the adapter's mains input plug fitting your power outlet. Plug the adapter's DC output connector into the *Bode 100* DC power input on the rear panel and the mains input plug into the power outlet. Alternatively, you can power the *Bode 100* with any DC power supply meeting the power requirements specified on page 182.

2.3 Connecting the *Bode 100* to the Computer

The *Bode 100* communicates with the computer through USB interface (see 13.4 "System Requirements" on page 183). Connect the *Bode 100* USB connector on the rear panel to the USB connector of your computer using the USB cable delivered with your *Bode 100*.

2.4 How to Proceed

Now, you are ready to work with your *Bode 100*. You can proceed with Section 3 "Gain/Phase Mode" to make your first measurement with the *Bode 100*, and then go through the Bode 100 User Manual to learn the capabilities of your *Bode 100* by doing practical examples. For the *Bode Analyzer Suite* basics, see Section 9 "Common Functions".

3 Gain/Phase Mode

Figure 3-1:
Gain/Phase mode
window

Menu bar

Allows access to all *Bode 100* functions. See 9.1 "Toolbars, Menus and Commands" on page 117.

Calibration and trace functions toolbar (disabled)

Choose the calibration mode and switch the calibration on and off. Switch the trace functions on and off. See Figure 9-2: "Calibration and trace functions toolbar" on page 117.

Toolbar

Contains shortcuts to the most important *Bode 100* functions.

See Figure 9-1: "Toolbar" on page 117.

Results

Select the result format and get result values. See Figure 3-3: "Gain/Phase mode results" on page 20.

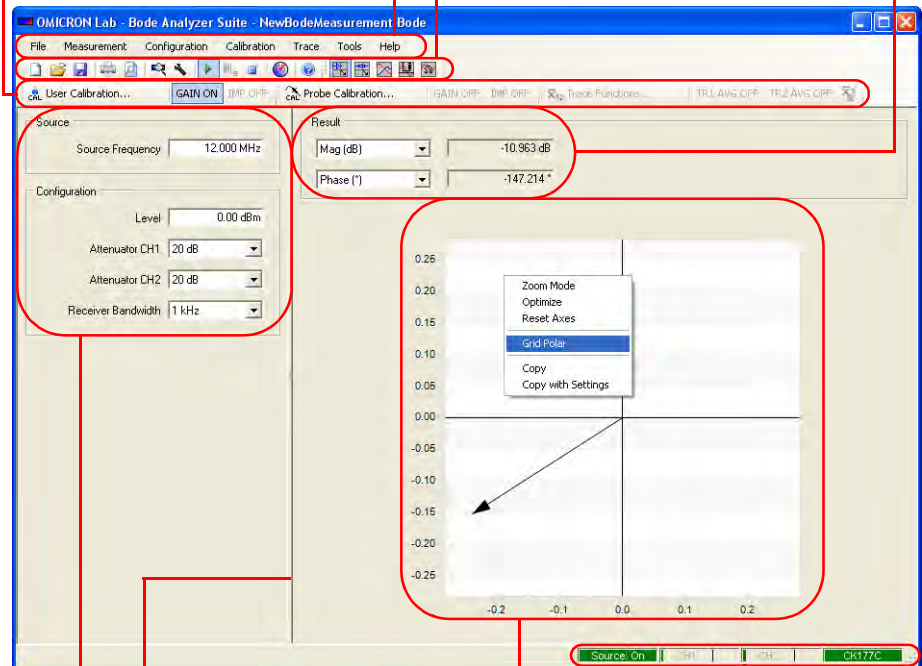

Split bar

Drag the split bar to resize the panes.

Configuration and measurement setup

See Figure 3-2: "Configuration and measurement setup" on page 20.

Source, overload, and connection indicators

See Figure 3-5: "Source, overload, and connection indicators" on page 21.

Graphical display of measurement results

Use the shortcut menu to optimize the display.

See Figure 3-4: "Graphical display of measurement results" on page 21.

Figure 3-2:
Configuration and
measurement setup

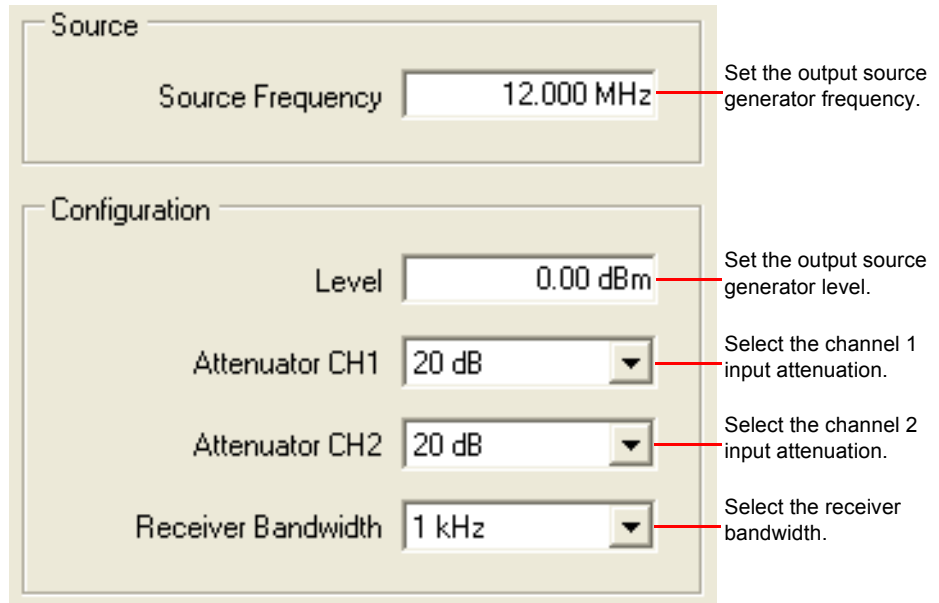

Hint: A higher receiver bandwidth allows faster measurements, a lower receiver bandwidth increases the measurement accuracy.

Figure 3-3:
Gain/Phase mode
results

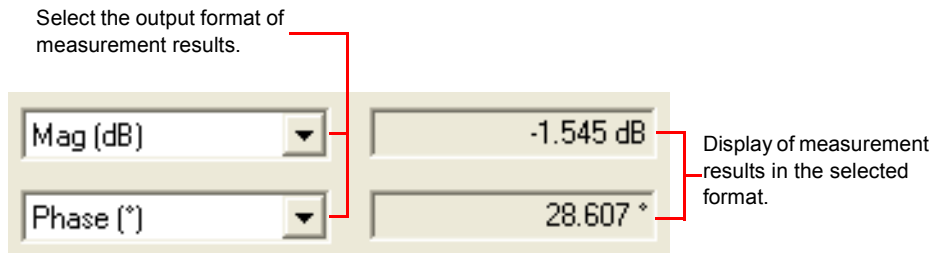
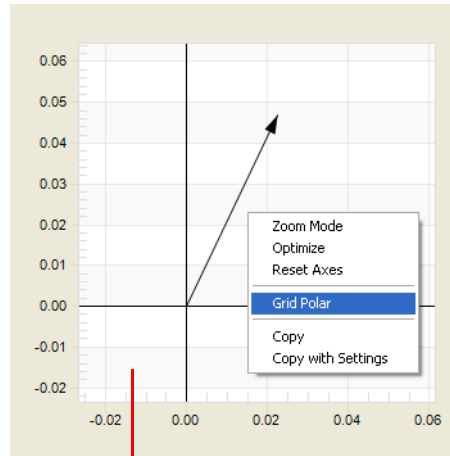

Figure 3-4:
Graphical display of
measurement results



Right-click in the diagram to open the shortcut menu. Use the shortcut menu to optimize the diagram, select the grid and zoom in the diagram. After having zoomed in, click **Optimize** to get back to an optimized diagram.

Hint: Using the **Copy** and **Copy with Settings** functions you can easily export your diagram into other Windows® applications. For more information, see 10.1 "Advanced Display Options" on page 125.

Figure 3-5:
Source, overload, and
connection indicators

Overload indicators for the channel 1 and channel 2 inputs. If you see a red bar, increase the attenuation of the respective channel or reduce the source level to prevent the overload.

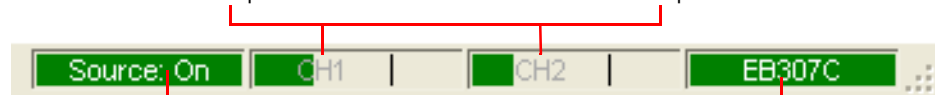

Source indicator (see 3.3 "Example: Gain/Phase")

Serial number of the *Bode 100*

Hint: If the serial number field in the status bar displays **No Device** on red background, check whether the *Bode 100* is powered and connected to your computer, and then click the **Search and Reconnect Device** toolbar button  to reconnect the *Bode 100*.

3.1 Basics



The gain and phase of the DUT is calculated from the measurement data obtained using the reference channel 1 and the measurement channel 2. You can connect the signal source to the reference channel internally or externally as described in 3.2 "Choosing the Reference Connection" on page 24.

The basic definitions and formulas related to the gain/phase measurements are summarized below:

$$|\underline{H}(f)| = \text{abs}\{\underline{H}(f)\} \quad (\text{Eq. 3-1})$$

$$\phi(f) = \text{arg}\{\underline{H}(f)\} \quad (\text{Eq. 3-2})$$

$$T_g(f) = -\frac{1}{2\pi} \cdot \frac{d}{df}\phi(f) = -\frac{d}{d\omega}\phi(\omega) \quad (\text{Eq. 3-3})$$

where

$\underline{H}(f)$...displayed gain/phase function

$|\underline{H}(f)|$...magnitude of $\underline{H}(f)$

$\phi(f)$...phase of $\underline{H}(f)$

$T_g(f)$...group delay of $\underline{H}(f)$

$$S_{ji}(f) = 2 \cdot \frac{V_{OUT}}{V_0}, i \neq j \quad (\text{Eq. 3-4})$$

$$\underline{H}_T(f) = \frac{V_{OUT}}{V_{IN}} \quad (\text{Eq. 3-5})$$

where

$S_{ji}(f)$...S parameter from port i to port j ($i \neq j$) of the DUT

$\underline{H}_T(f)$...transfer function of a two-port device, $\underline{H}_T(f)$ depends on the load of the port where V_{OUT} is measured

V_{OUT} ...voltage at the DUT's output

V_0 ...open-circuit voltage of the source

V_{IN} ...voltage at the DUT's input

V_{CH1} ...voltage at the channel 1 input

V_{CH2} ...voltage at the channel 2 input

Z_{IN} ...input impedance of the DUT

R_S ...50 Ω source resistance

Assumptions for measuring $S_{ji}(f)$:

- The source with resistance $R_S = 50 \Omega$ is connected to port i .
- 50 Ω load (receiver resistance) at port j measuring V_{OUT} , any other ports of the DUT are terminated with 50 Ω .
- Connections are made with 50 Ω cables.

3.1.1 Internal Reference Connection

The basic formulas for the internal reference connection are summarized below.

Note: In the internal reference connection mode of the *Bode 100*, the reference voltage for the gain/phase measurement is always $V_0/2$.

Table 3-1:
Formulas for Internal
Reference Connection

Channel 2 Input Resistance	
50 Ω	High Impedance
$V_{CH1} = \frac{V_0}{2}$ (Eq. 3-6)	$V_{CH1} = \frac{V_0}{2}$ (Eq. 3-7)
$V_{CH2} = V_{OUT}$ (Eq. 3-8)	$V_{CH2} = V_{OUT}$ (Eq. 3-9)
	$V_{IN} = V_0 \cdot \frac{Z_{IN}}{(Z_{IN} + R_S)}$ (Eq. 3-10)
$H(f) = \frac{V_{CH2}}{V_{CH1}} = 2 \cdot \frac{V_{OUT}}{V_0}$ = $S_{ji}(f)$ of the DUT (Eq. 3-11)	$H(f) = \frac{V_{CH2}}{V_{CH1}} = 2 \cdot \frac{V_{OUT}}{V_0}$ = $2 \cdot \frac{V_{OUT}}{V_{IN}} \cdot \frac{Z_{IN}}{(Z_{IN} + R_S)}$ (Eq. 3-12)
	$H(f) = 2 \cdot H_T(f) \cdot \frac{Z_{IN}}{(Z_{IN} + R_S)}$ (Eq. 3-13)
If you make a through connection from the source to CH 2: 0 dB gain will be displayed since $V_{CH2} = V_0/2$	If you make a through connection from the source to CH 2: +6 dB gain will be displayed since $V_{CH2} = V_0$

3.1.2 External Reference Connection

Independent of the selected input impedance at the channel 1 and channel 2 inputs, the following formulas apply:

$$V_{CH1} = V_{IN} \quad (\text{Eq. 3-14})$$

$$V_{CH2} = V_{OUT} \quad (\text{Eq. 3-15})$$

$$H(f) = H_T(f) = \frac{V_{CH2}}{V_{CH1}} = \frac{V_{OUT}}{V_{IN}} \quad (\text{Eq. 3-16})$$

3.2 Choosing the Reference Connection

Open the **Configuration** window by clicking **Device Configuration** on the **Configuration** menu or the **Device Configuration** toolbar button  (see 3.3 "Example: Gain/Phase Measurement" on page 26). By default, the **Device Configuration** tab is selected.

To connect the reference internally, set the marked configuration field as shown below.

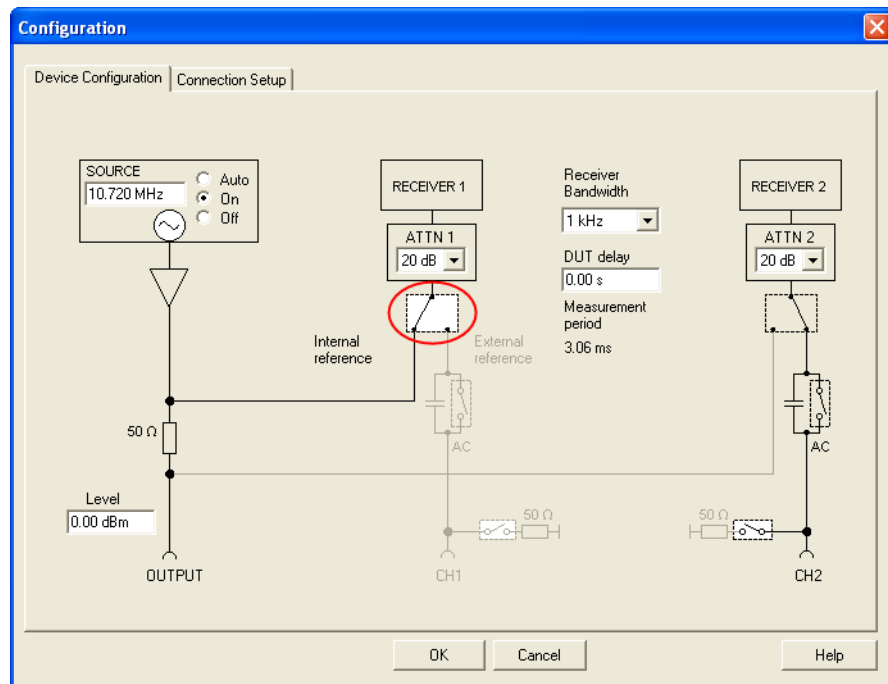

Note: The source signal is internally connected to the channel 1 input (CH1) in front of the 50 Ω source resistor (channel 1 voltage $V_{CH1} = V_0/2$ as defined in 3.1 "Basics" on page 22).

To connect the reference externally:

1. Set the marked configuration field as shown in the following figure.

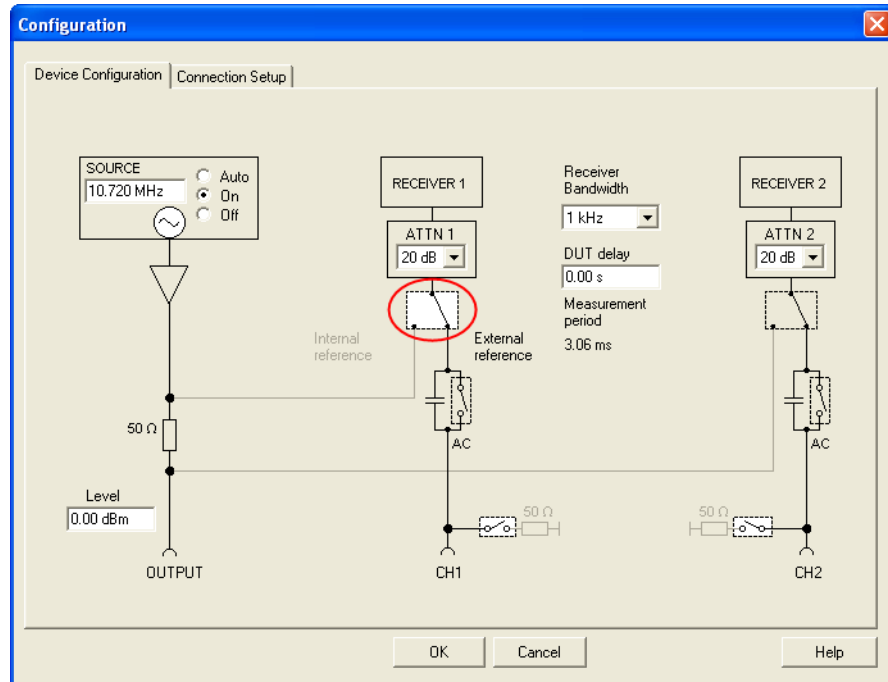

Note: The source signal is externally connected to the channel 1 input (CH1) behind the 50 Ω source resistor (channel 1 voltage $V_{CH1} = V_{IN}$ as defined in 3.1 "Basics" on page 22).

2. Connect the reference point of the DUT to the INPUT CH 1 connector using a cable.

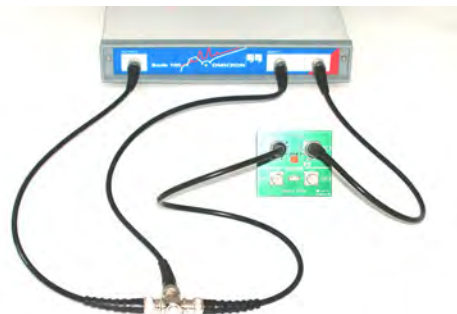

3.3 Example: Gain/Phase Measurement

Expected example duration: 20 minutes.

In this example you will learn step by step how to use the **Gain/Phase** mode of the *Bode 100*.

How to:

- Measure the gain and phase of a DUT with a sinusoidal signal at a frequency
- Set the bandwidth, attenuators and amplitudes of the *Bode 100*
- Optimize the diagram
- Compensate the connection cables in the **Gain/Phase** mode

Question: What is the magnitude in dB of the delivered IF filter at 10.7 MHz?
These types of 10.7 MHz filters are used in FM radios.

To find out the answer, proceed as follows:

1. Connect the *Bode 100* and start the *Bode Analyzer Suite*.
2. Click the **Gain/Phase** toolbar button .

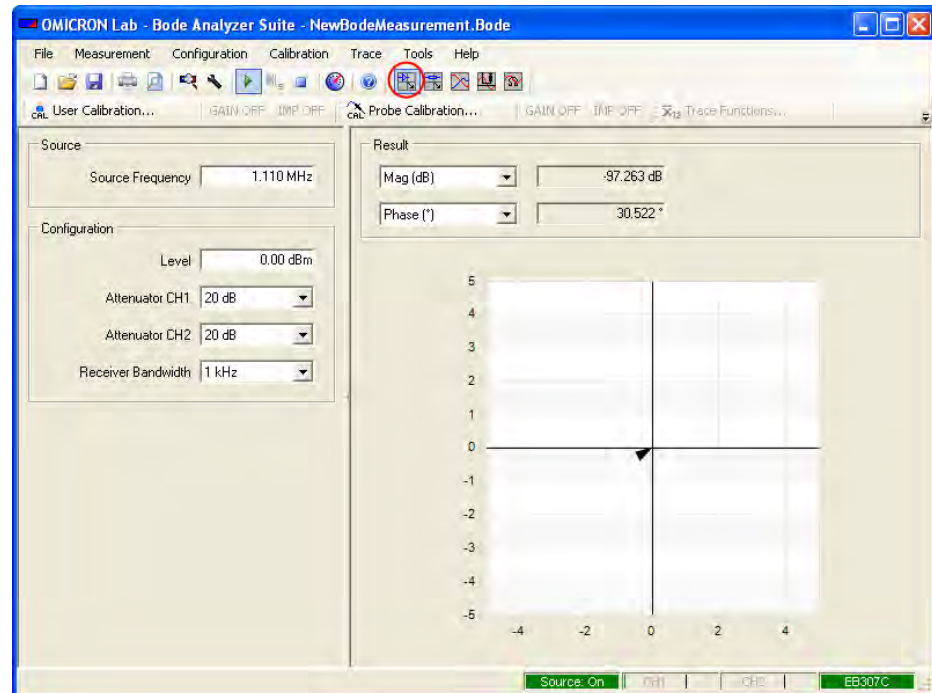

Hint: If you see the *Bode 100* serial number in the status bar on the lower right side of the window then the *Bode Analyzer Suite* communicates with the *Bode 100*. Otherwise check whether your *Bode 100* is connected and powered properly, and then click the **Search and Reconnect Device** toolbar button .

3. Click the **Device Configuration** toolbar button  to configure the **Gain/Phase** mode.

4. In the **Configuration** window, set:

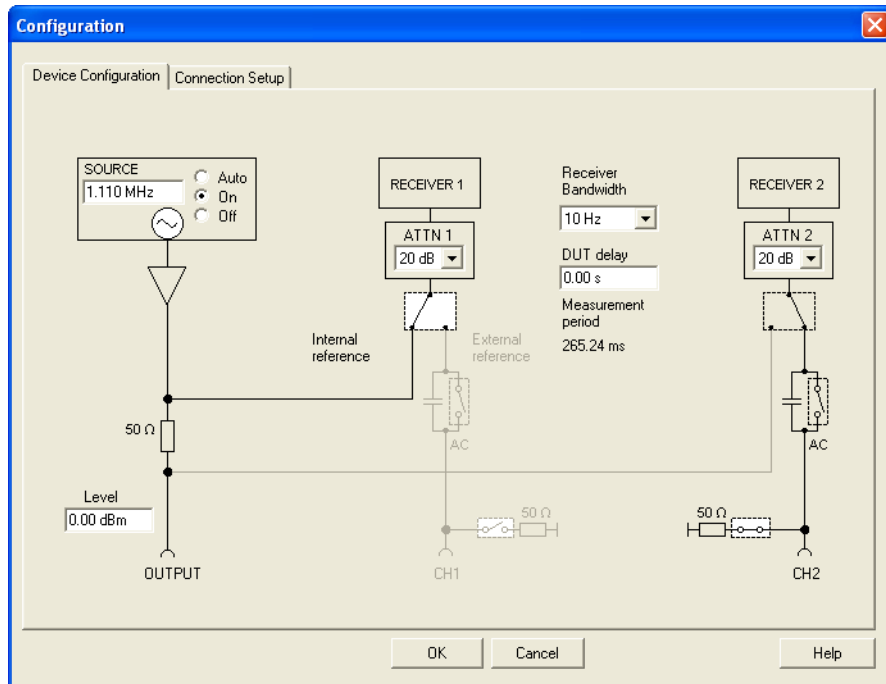

- CH2: 50 Ω ON (click the switch as shown)

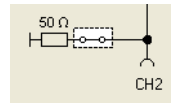

- SOURCE: 10.7 MHz
- SOURCE: On or Auto
- Receiver bandwidth: 10 Hz
- ATTN 1 (channel 1 input attenuator): 20 dB
- ATTN 2 (channel 2 input attenuator): 20 dB
- The switch  (before ATTN1) to the internal source as reference
- Level: 0 dBm

Hint: Setting the receiver bandwidth to 10 Hz makes the readout more stable but also makes the measurement slower.

- Click the **Connection Setup** tab.

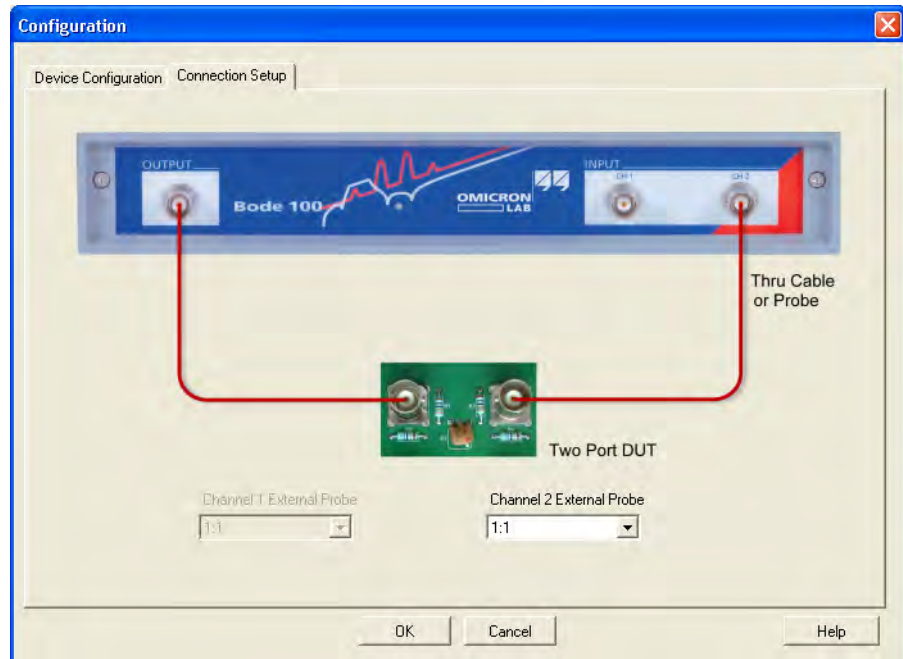

The connection diagram shows how to connect the DUT to the *Bode 100*.

Hint: Set the voltage ratio in the box Channel 2 External Probe: if you use a probe instead of cable connection (see 10.2 "Advanced Sweep Options" on page 140).

- Connect the IF filter to the *Bode 100* as shown.



7. Click to close the **Configuration** window and to get back to the **Gain/Phase** mode window.
8. For a better view of the **Gain/Phase** vector in the complex plane, right-click in the diagram, and then click **Optimize**.

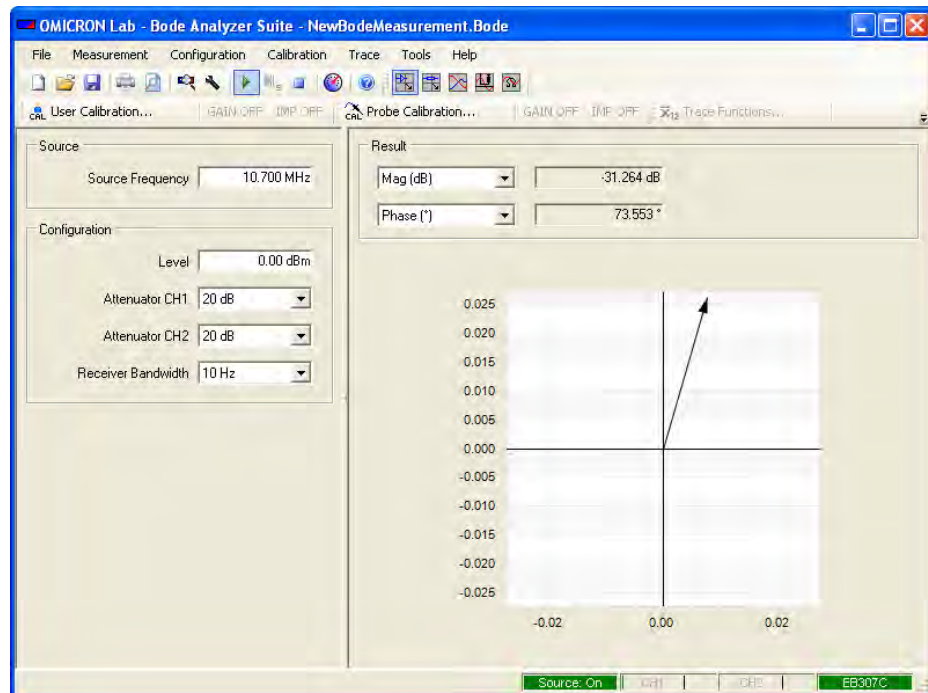
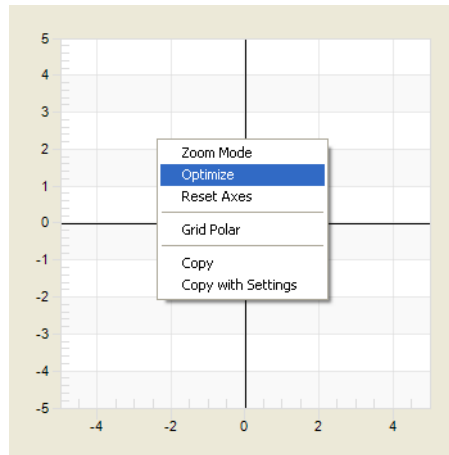

Result: The IF filter has a magnitude of -31.26 dB at 10.7 MHz. Your result may differ because each IF filter is slightly different.

The phase readout of 73.6° is not the value you want to measure because it is the sum of the phase shift of the cables and of the IF filter. To get the value of the IF filter only, use the **Gain/Phase** calibration to compensate the phase shift of the cables.

Continue the example and calibrate the *Bode 100* to get the phase shift of the IF filter:

1. Replace the IF filter with the BNC straight adapter (f-f).



2. Click the **User Calibration** toolbar button  **User Calibration...** to open the calibration window.
3. In the calibration window, click **Start** in the **Gain/Phase** area.

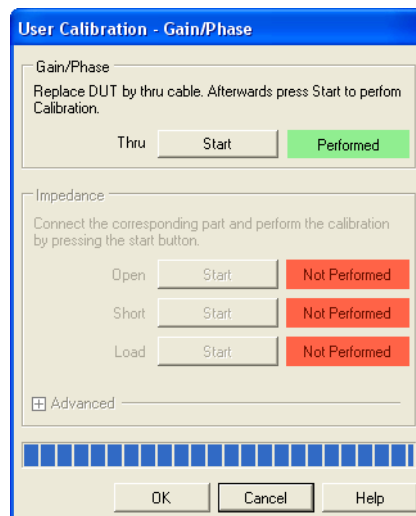

The calibration takes only a few seconds. The **Gain/Phase** mode is now calibrated for the current specific measurement setup.

4. Click .

5. Reconnect the IF filter.

Hint: If you change settings you must repeat the **User Calibration**. If you use the **Probe Calibration**  instead you can change settings without repeating the calibration. For more information, see 8 "Calibrating the Bode 100" on page 89.

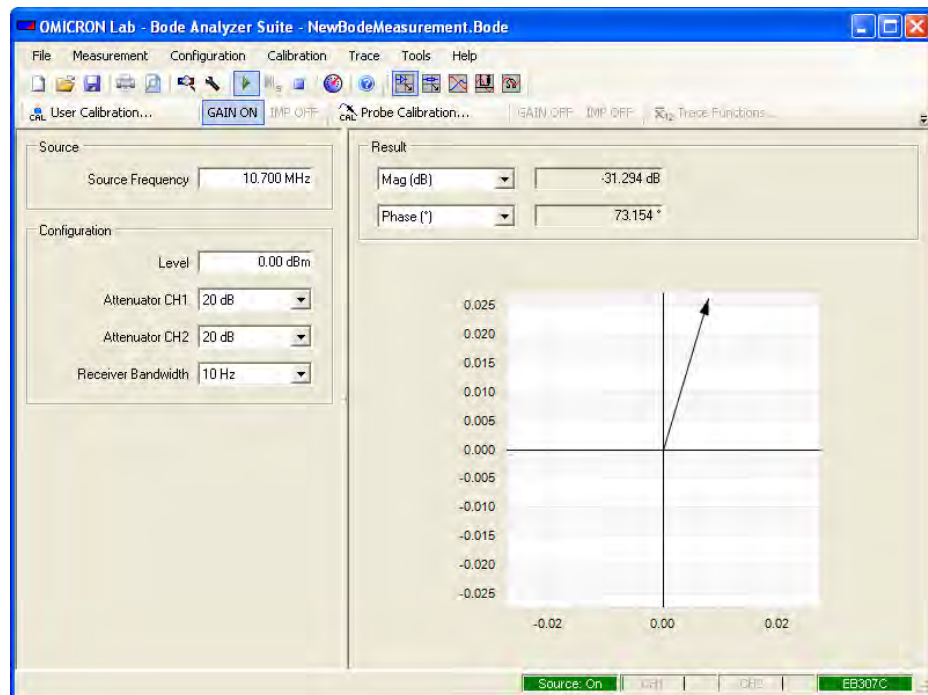

Result: The transfer function of the IF filter has a magnitude of -31.29 dB and a phase shift of 73.2° at 10.7 MHz.

Again, your results may differ because every IF filter and measurement setup is slightly different.

Hint: You can toggle between the measurement results with calibration and without calibration by clicking the **GAIN ON** toolbar button .



As OMIfuzius said: Only applied knowledge changes the world. We are responsible to change it to the better.

Congratulation! You learned how to use the **Gain/Phase** mode.

How to:

- Measure the gain and phase shift of a DUT using a sinusoidal signal at a certain frequency
- Set the bandwidth, attenuators and amplitude of the *Bode 100*
- Optimize the diagram
- Compensate the connection cables in the **Gain/Phase** mode

Go back to the overview chart at 3 "Gain/Phase Mode" on page 19 and try different settings to check out their effect on the measurement.

This page intentionally left blank

4 Impedance/Reflection Mode

Figure 4-1:
Impedance/Reflection
mode window

For the description of the menu bar, toolbar, and calibration and trace functions toolbar, see 9 "Common Functions" on page 117.

Graphical display of measurement results
Use the shortcut menu to optimize the display.
See Figure 3-4: "Graphical display of measurement results" on page 21.

Results

Select the result format and get result values.
See Figure 4-2: "Impedance/Reflection mode results" on page 36.

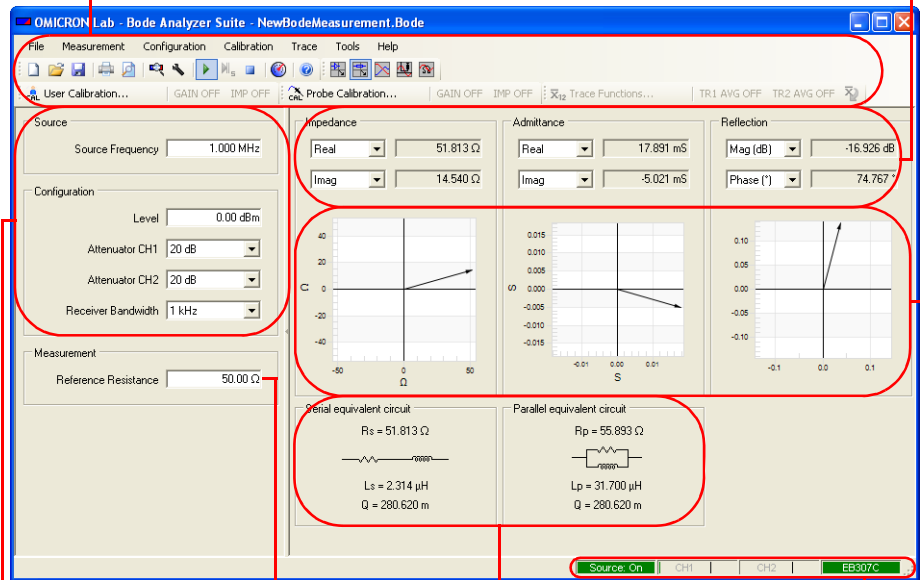

Reference resistance
Set the reference resistance (see 4.1.1 "General Formulas" on page 36).

Equivalent circuits
View the equivalent circuits (see 4.1.2 "Equivalent Circuits" on page 37).

Source, overload, and connection indicators
See Figure 3-5: "Source, overload, and connection indicators" on page 21.

Configuration and measurement setup
See Figure 3-2: "Configuration and measurement setup" on page 20.

Figure 4-2:
Impedance/Reflection
mode results

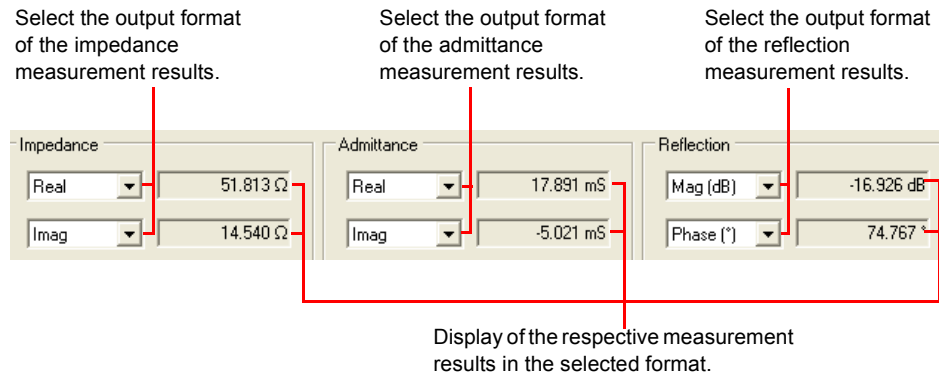

4.1 Basics

4.1.1 General Formulas



The general formulas related to the **Impedance/Reflection** measurements are summarized below:

$$\underline{Z} = \frac{\underline{V}}{\underline{I}} \quad (\text{Eq. 4-1})$$

$$\underline{Y} = \frac{\underline{I}}{\underline{V}} = \frac{1}{\underline{Z}} \quad (\text{Eq. 4-2})$$

$$r = \frac{\underline{Z} - R_0}{\underline{Z} + R_0} = \frac{G_0 - \underline{Y}}{G_0 + \underline{Y}} \quad (\text{Eq. 4-3})$$

$$VSWR = \frac{1 + |r|}{1 - |r|} \quad (\text{Eq. 4-4})$$

$$R_0 = \frac{1}{G_0} \quad (\text{Eq. 4-5})$$

where

- \underline{V} ...voltage at the reference plane
- \underline{I} ...current at the reference plane
- \underline{Z} ...impedance
- \underline{Y} ...admittance
- r ...reflection coefficient
- $VSWR$...voltage standing wave ratio
- R_0 ...reference resistance
- G_0 ...reference conductance

Note: The reference resistance R_0 can be set in the **Measurement** area of the **Impedance/Reflection** mode window.

4.1.2 Equivalent Circuits

The basic formulas for the serial equivalent circuit are:

$$\underline{Z} = \text{Real}(\underline{Z}) + j\text{Imag}(\underline{Z}) = R_s + jX_s \quad (\text{Eq. 4-6})$$

$$R_s = \text{Real}(\underline{Z}) \quad (\text{Eq. 4-7})$$

If $\text{Imag}(\underline{Z}) < 0$:

$$C_s = \frac{1}{\omega |\text{Imag}(\underline{Z})|} \quad (\text{Eq. 4-8})$$

If $\text{Imag}(\underline{Z}) > 0$:

$$L_s = \frac{|\text{Imag}(\underline{Z})|}{\omega} \quad (\text{Eq. 4-9})$$

where

R_s ...series resistance

X_s ...series reactance

C_s ...series capacitance

L_s ...series inductance

The basic formulas for the parallel equivalent circuit are:

$$\underline{Y} = \text{Real}(\underline{Y}) + j\text{Imag}(\underline{Y}) = \frac{1}{R_p} + j\left(\frac{-1}{X_p}\right) \quad (\text{Eq. 4-10})$$

$$R_p = \frac{1}{\text{Real}(\underline{Y})} \quad (\text{Eq. 4-11})$$

If $\text{Imag}(\underline{Y}) < 0$:

$$L_p = \frac{1}{\omega |\text{Imag}(\underline{Y})|} \quad (\text{Eq. 4-12})$$

If $\text{Imag}(\underline{Y}) > 0$:

$$C_p = \frac{|\text{Imag}(\underline{Y})|}{\omega} \quad (\text{Eq. 4-13})$$

where

R_p ...parallel resistance

X_p ...parallel reactance

L_p ...parallel inductance

C_p ...parallel capacitance

Depending on the regional settings of your computer the elements of the serial and parallel equivalent circuits are displayed according to the *IEC* (International Electronic Commission) or *ANSI* (American National Standards Institute) standards as shown below.

Figure 4-3:
Resistor and inductor
symbols according to
ANSI

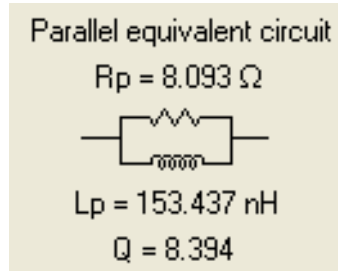
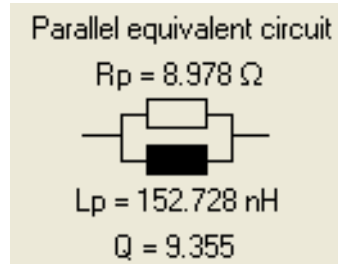



Figure 4-4:
Resistor and inductor
symbols according to
IEC



Note: Capacitors have the same symbol  in both standards.

4.1.3 Quality Factor

An ideal inductor will be lossless irrespective of the amount of current flowing through the winding. An ideal capacitor will be lossless irrespective of the voltage applied to it. However, real inductors have a winding resistance due to the metal wire forming the coils and real capacitors have a resistance due to the used insulation material. These resistances cause a loss of inductive or capacitive quality. For serial equivalent circuits, the quality factor Q is defined as the ratio of the reactance to the resistance at a given frequency. For parallel equivalent circuits, the quality factor Q is defined as the ratio of the resistance to the reactance at a given frequency. The Q factor is a measure of the inductor's and capacitor's efficiency. The higher the Q factor of a capacitor or inductor, the closer the capacitor/inductor approaches the behavior of an ideal, lossless component.

The Q factor calculated using the serial equivalent circuit is given by

$$Q = \frac{|\text{Imag}(Z)|}{\text{Real}(Z)} = \frac{|X_s|}{R_s} \quad (\text{Eq. 4-14})$$

and using the parallel equivalent circuit is given by

$$Q = \frac{|\text{Imag}(Y)|}{\text{Real}(Y)} = \frac{\frac{1}{|X_p|}}{\frac{1}{R_p}} = \frac{R_p}{|X_p|} \quad (\text{Eq. 4-15})$$

4.2 Example: Impedance/Reflection Measurement

Expected example duration: 20 minutes.

In this example you will learn step by step how to use the **Impedance/Reflection** mode of the *Bode 100*.

How to:



- Measure the reflection coefficient at a frequency
- Set the bandwidth and amplitudes used for the measurement
- Connect the DUT for the impedance and reflection measurement
- Optimize the diagrams
- Work with the serial and parallel equivalent circuits

Question: What is the reflection coefficient in dB of the delivered IF filter's input at 10.7 MHz?

To find out the answer, proceed as follows:

1. Connect the *Bode 100* and start the *Bode Analyzer Suite*.

Hint: If you see the serial number of your *Bode 100* on the lower right side of the status bar then your *Bode 100* is working properly.

2. Click the **Impedance/Reflection** toolbar button  to switch to the **Impedance/Reflection** mode.
3. If necessary, adjust your window size. Move the mouse to the lower right corner of the window . By dragging the corner you can adjust the window.

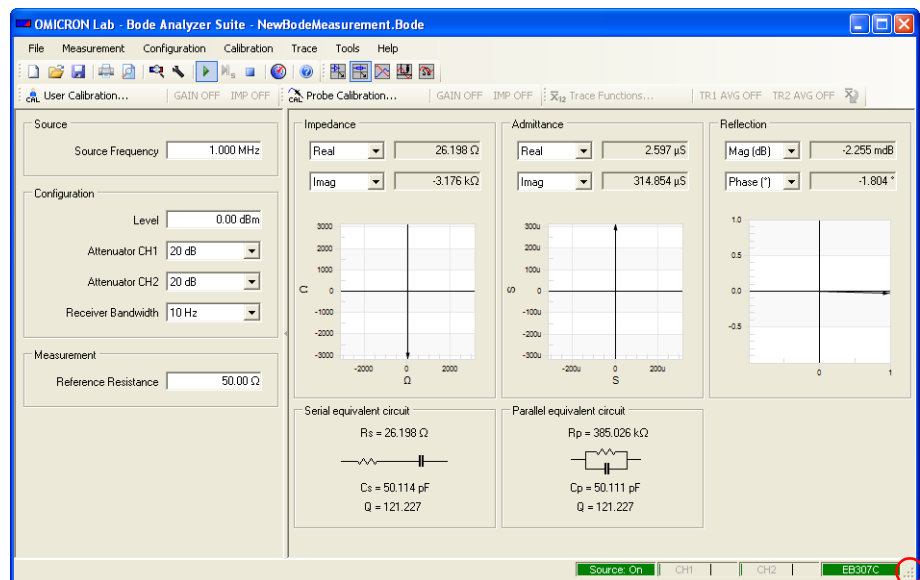

- Click the **Device Configuration** toolbar button  to configure the **Impedance/Reflection** mode.

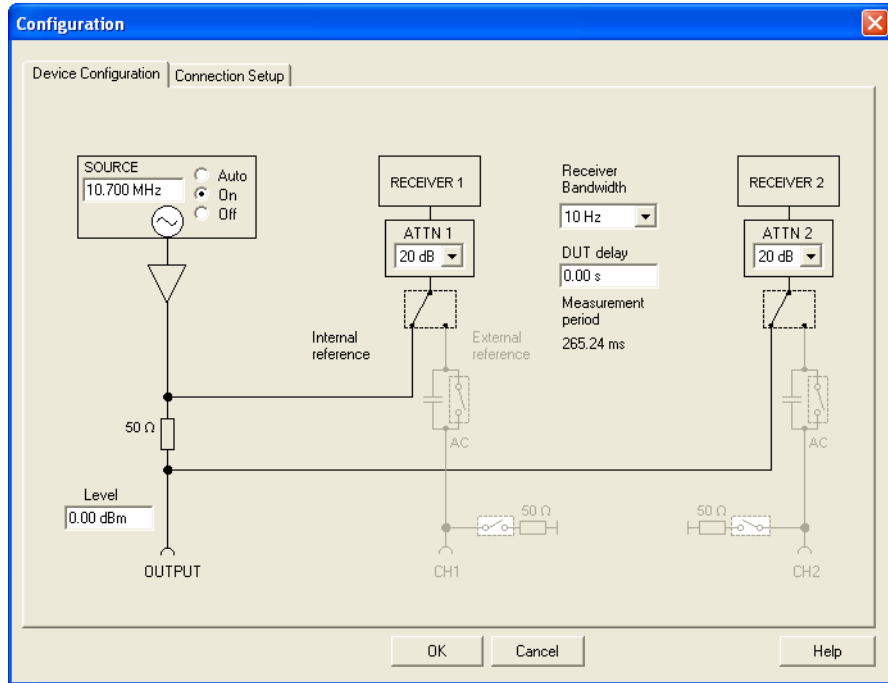

5. Set:
 - SOURCE: 10.7 MHz
 - SOURCE: On or Auto
 - Receiver bandwidth: 10 Hz
 - Level: 0 dBm
6. Click the **Connection Setup** tab.

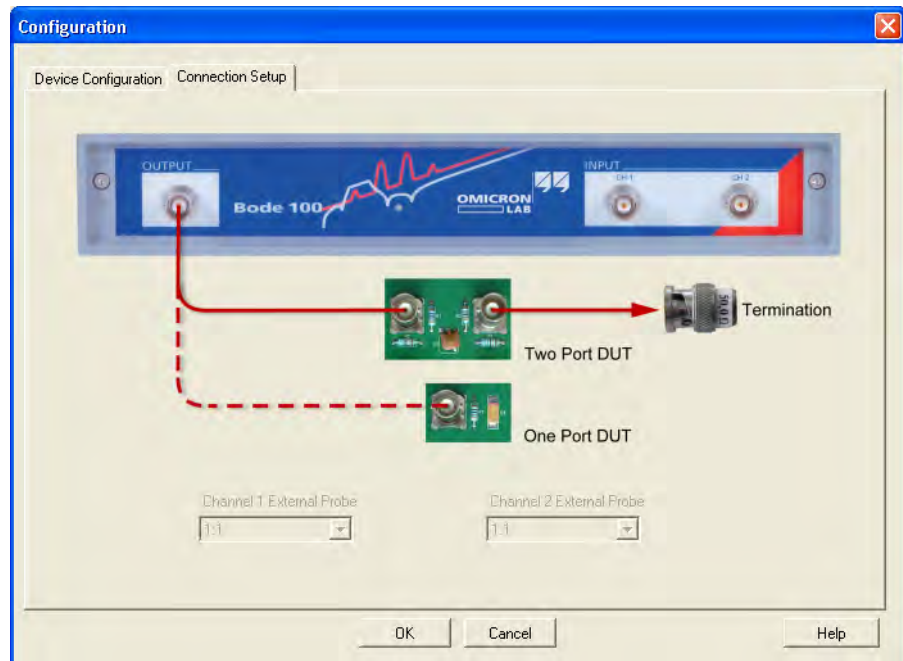

The connection diagram shows how to connect the DUT to the *Bode 100*.

Hint: In the **Impedance/Reflection mode**, the channel 1 and channel 2 inputs are not used. Consequently, the **External Probe** boxes are unavailable.

7. Connect the output of the *Bode 100* to the input of the IF filter and the BNC 50 Ω load to the output of the IF filter as shown.



8. Click to close the **Configuration** window.
9. For a better view of the impedance, admittance and reflection vectors in the complex plane, right-click in the respective diagrams, and then click **Optimize**.



10. View the results.

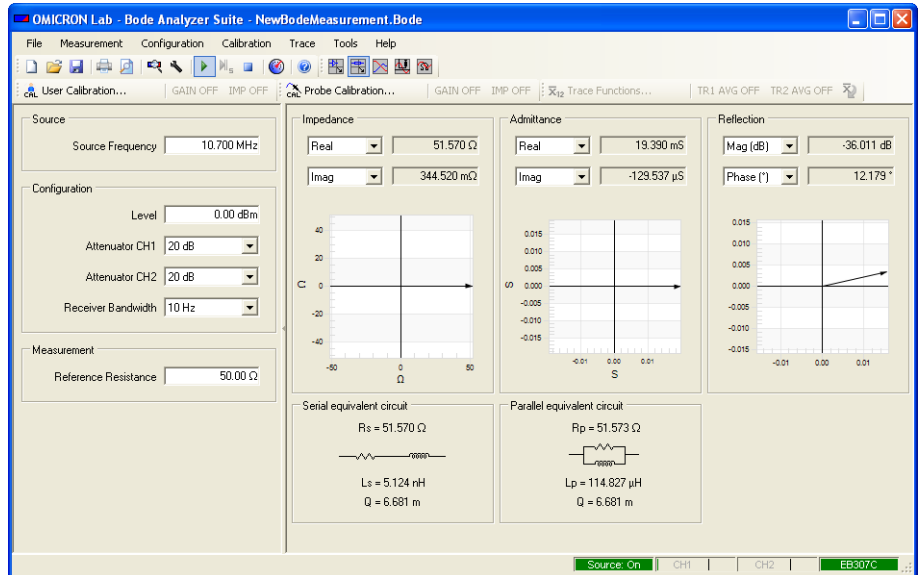

Result: The measured values of the IF filter at 10.7 MHz are:

- Reflection coefficient: -36.0 dB
- Impedance: nearly 50Ω

Again, your results may differ because every IF filter and measurement setup is slightly different.

Hint: To increase the size of the diagrams, make the window larger or hide the left pane by clicking the split bar. To restore the left pane, click the split bar again.

Hint: If you want to display the reflection in VSWR format select the **VSWR** output format under **Reflection** as shown below.

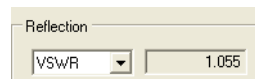

Usually, the reference resistance of 50Ω is used to calculate the reflection coefficient and the VSWR. The **Reference Resistance** box allows you to enter other reference resistance values if required.

The parallel and serial equivalent circuits give us an indication of the electrical components that would be required to rebuild the electrical characteristics of your DUT at the measurement frequency. In our example you would require a 5.124 nH inductor and a 51.57Ω resistor to build the series equivalent circuit.

Try it out, get yourself the required components and repeat the measurement. If the results do not match 100% keep in mind that you are using real components with a Q factor on their own.

For information on how to calibrate the *Bode 100* in the **Impedance/Reflection** mode, see 8.4 "Calibration in the Impedance/Reflection Mode" on page 97.

Congratulation! You learned how to use the **Impedance/Reflection** mode.

How to:

- Measure the reflection coefficient at a frequency
- Set the bandwidth and amplitudes used for the measurement
- Connect the DUT for the impedance and reflection measurement
- Optimize the diagrams
- Understand serial and parallel equivalent circuits

Go back to the overview chart at 4 "Impedance/Reflection Mode" on page 35 and try things out.



After this example get a glass of water to increase your reflection mode and your attention bandwidth. Then try things out and right-click and left-click to everything that does not move on the screen.

This page intentionally left blank

5 Frequency Sweep Mode

Figure 5-1:
Frequency Sweep
mode window

Sweep settings

Set frequency sweep.
See Figure 5-2: "Sweep
settings" on page 48.

Cursor settings

Set cursors and view
measurement results.
See Figure 5-3: "Cursor
settings" on page 48.

Trace settings

Define measurement format
and display options.
See Figure 5-4: "Trace
settings" on page 49.

Trace functions settings

Switch the **Average**, **Min Hold**, and **Max Hold** functions on
and off. See 5.1 "Example: Frequency Sweep Measurement"

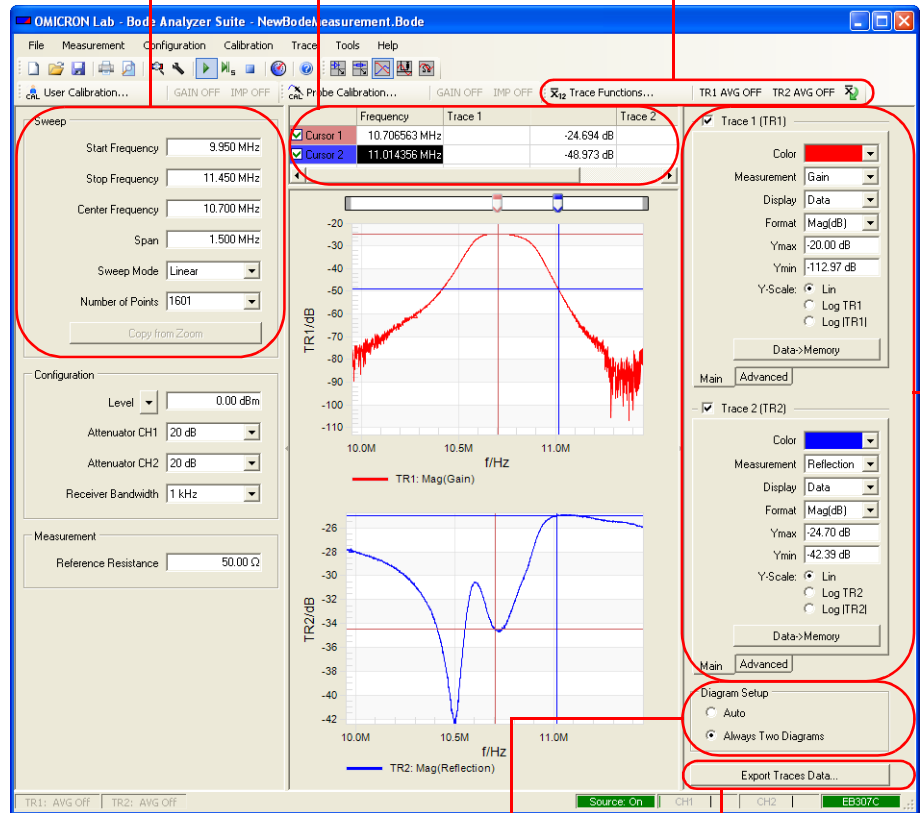

Diagram setup

See Figure 5-6: "Diagram
setup" on page 51.

Export traces data

Export traces as CSV file.
See 9.4.2 "Exporting Measurement
Data" on page 122.

Note: Only window areas specific for the **Frequency Sweep** mode are explained here. For window areas common to other measurement modes, see Figure 3-1: "Gain/Phase mode window" on page 19 and Figure 4-1: "Impedance/Reflection mode window" on page 35.

 In the **Frequency Sweep** mode you can perform a sequence of **Gain/Phase** and/or **Impedance/Reflection** measurements and examine the results in different types of diagrams.

Figure 5-2:
Sweep settings



The screenshot shows the 'Sweep' dialog box with the following settings and annotations:

- Start Frequency:** 9.950 MHz (Annotation: Set the frequency sweep start frequency.)
- Stop Frequency:** 11.450 MHz (Annotation: Set the frequency sweep stop frequency.)
- Center Frequency:** 10.700 MHz (Annotation: Set the frequency sweep center frequency.)
- Span:** 1.500 MHz (Annotation: Set the frequency sweep span.)
- Sweep Mode:** Linear (Annotation: Click **Linear** or **Logarithmic** to select the respective scale of measurement points.)
- Number of Points:** 1601 (Annotation: Set the number of measurement points.)
- Copy from Zoom** button (Annotation: See "Copy from Zoom" on page 131.)

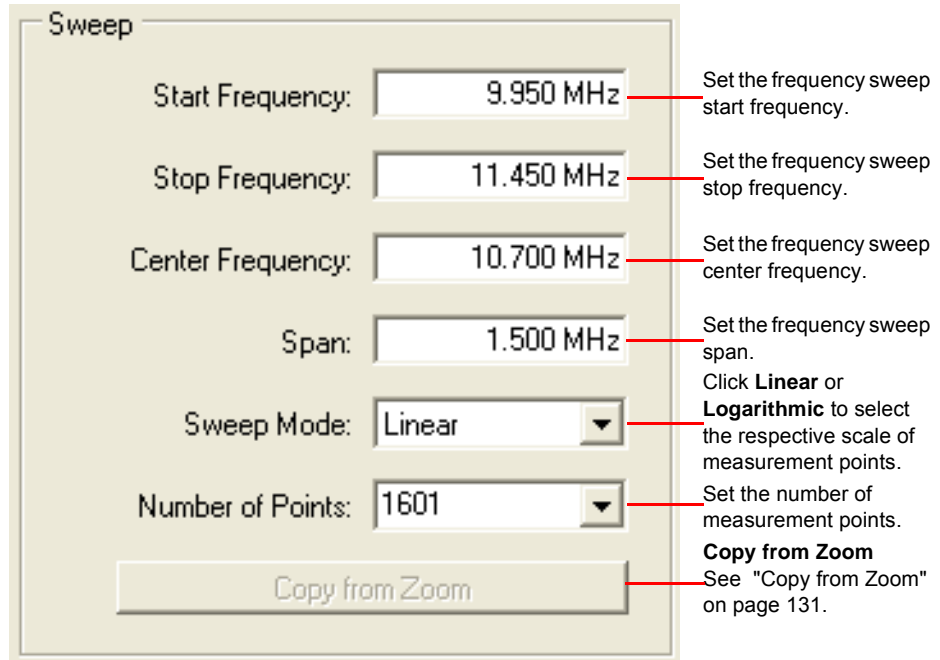
Hint: The start frequency, stop frequency, center frequency and span are mutually dependent. After one of them has been changed, the others settings are recalculated by the *Bode Analyzer Suite*.

Figure 5-3:
Cursor settings

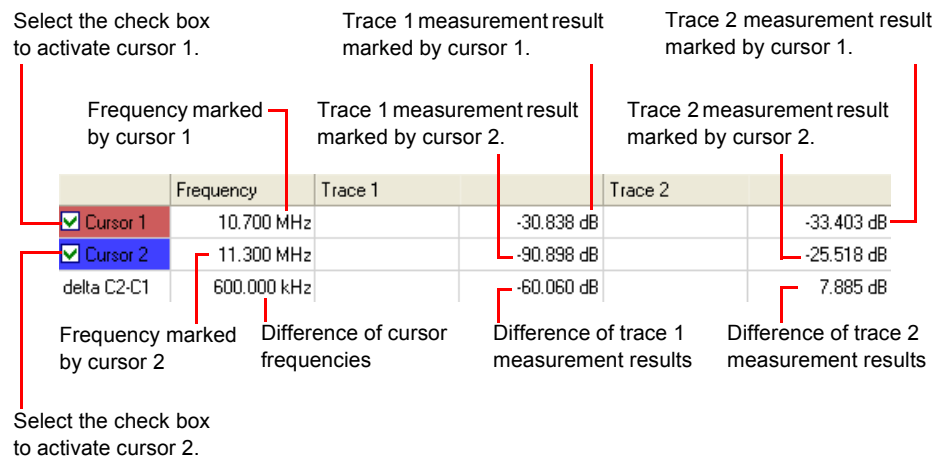

The screenshot shows a table for cursor settings with the following data and annotations:

	Frequency	Trace 1	Trace 2
<input checked="" type="checkbox"/> Cursor 1	10.700 MHz	-30.838 dB	-33.403 dB
<input checked="" type="checkbox"/> Cursor 2	11.300 MHz	-90.898 dB	-25.518 dB
delta C2-C1	600.000 kHz	-60.060 dB	7.885 dB

Annotations for the table:

- Select the check box to activate cursor 1.
- Trace 1 measurement result marked by cursor 1.
- Trace 2 measurement result marked by cursor 1.
- Frequency marked by cursor 1.
- Trace 1 measurement result marked by cursor 2.
- Trace 2 measurement result marked by cursor 2.
- Frequency marked by cursor 2.
- Difference of cursor frequencies.
- Difference of trace 1 measurement results.
- Difference of trace 2 measurement results.
- Select the check box to activate cursor 2.

Figure 5-4:
Trace settings

Select the check box to activate trace 1.

Set the color of trace 1.

Click **Gain**, **Reflection**, **Impedance** or **Admittance** to select the respective trace 1 measurement.

Display
See "Data and Memory" on page 134.

Select the output format of trace 1 measurement results.

Set the maximum value on the trace 1 Y-axis.

Set the minimum value on the trace 1 Y-axis.

Data → Memory
See "Data and Memory" on page 134.

For the **Advanced** tab, see Figure 5-5: "Advanced trace settings" on page 50.

Main **Advanced**

Trace 1 (TR1)

Color [Red]

Measurement [Gain]

Display [Data]

Format [Mag(dB)]

Ymax [-30.07 dB]

Ymin [-102.93 dB]

Y-Scale: Lin
 Log TR1
 Log |TR1|

Data->Memory

Main **Advanced**

Trace 2 (TR2)

Color [Blue]

Measurement [Reflection]

Display [Data]

Format [Mag(dB)]

Ymax [-24.84 dB]

Ymin [-42.26 dB]

Y-Scale: Lin
 Log TR2
 Log |TR2|

Data->Memory

Main **Advanced**

Hint: The Trace 2 settings are as for Trace 1.

Figure 5-5:
Advanced trace settings

Select the check box to activate trace 1.

Select the check box to switch the unwrapped phase on. See 10.3 "Unwrapped Phase" on page 144.

Set the frequency from which the unwrapped phase measurement begins. See 10.3 "Unwrapped Phase" on page 144.

Set the frequency from which the phase is shown wrapped again. See 10.3 "Unwrapped Phase" on page 144.

Click the **Advanced** tab.

The screenshot shows two identical panels for Trace 1 (TR1) and Trace 2 (TR2). Each panel has a checked checkbox for the trace name. Below each is an 'Unwrapped Phase' section containing a checked checkbox for 'Unwrapped Phase', a 'Begin' field set to '100.000 kHz' with a checked checkbox, and an 'End' field set to '40.000 MHz' with a checked checkbox. At the bottom of each panel are 'Main' and 'Advanced' tabs, with the 'Advanced' tab selected.

Hint: The Trace 2 settings are as for Trace 1.

Figure 5-6:
Diagram setup

Click **Auto** to display both traces
in one diagram, if this is possible.

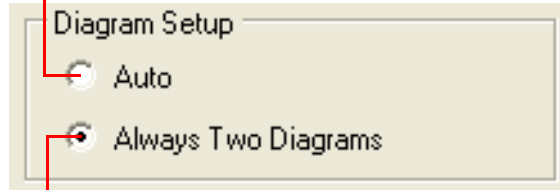

Click **Always Two Diagrams**
to display the traces in two
separate diagrams.

Note: **Diagram Setup** is only available if both traces are activated.

5.1 Example: Frequency Sweep Measurement

Expected example duration: 30 minutes.

In this example you will learn step by step how to use the **Frequency Sweep** mode of the *Bode 100*.

How to:



- Visualize measurement data in a graph
- Set configuration parameters like the input resistor and bandwidth
- Set sweep parameters like start and stop frequencies
- Use cursors to read single measurement points
- Calibrate and compensate the cables

Let's examine the 12 MHz quartz filter on the delivered printed circuit board (PCB).

Questions:

- How does the gain of the quartz filter look like if displayed as a function of frequency?
- How does the reflection coefficient of the quartz filter look in the Smith chart?
- What are the filter's series resonance and the parallel resonance frequencies?
- What is the attenuation of the quartz filter at its series resonance?
- What is the group delay T_g of the quartz filter at its series resonance?
- What is the series resistance R_s of the quartz filter?

To find out the answers, proceed as follows:

1. Connect the *Bode 100* to the computer and start the *Bode Analyzer Suite*.
2. Click the **Frequency Sweep** toolbar button  to switch to the **Frequency Sweep** mode.
3. Click the **Device Configuration** toolbar button  to configure the **Frequency Sweep** mode.
We want to measure the quartz filter with 50 Ω load.

4. Set:

- SOURCE: On or Auto
- CH2: 50 Ω ON (click the switch as shown)

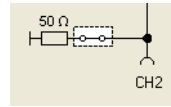

- The switch  (before ATTN1) to the internal source as reference

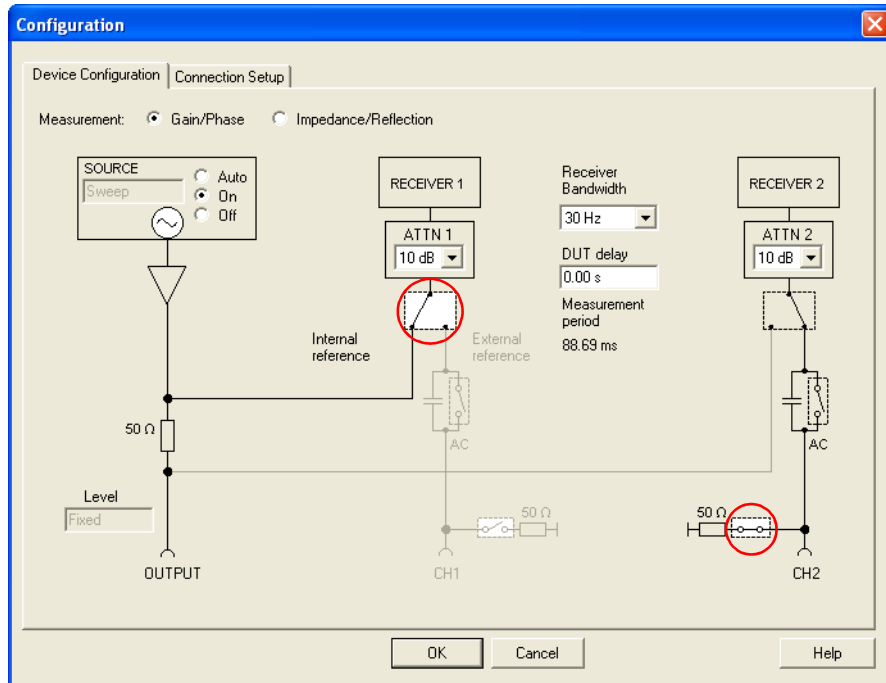

Hint: In the **Frequency Sweep** mode, the *Bode 100* can measure the gain/phase as well as the impedance/reflection of the DUT versus frequency. The **Gain/Phase** and **Impedance/Reflection** buttons in the **Configuration** window are just used to show the respective device configurations. The buttons have no impact on the measurements performed by the *Bode 100* – you select the measurement in the **Measurement** lists in the **Trace 1** and **Trace 2** areas (see Figure 5-4: "Trace settings" on page 49). To see the device configuration the *Bode 100* uses for the **Impedance/Reflection** measurement just click the **Impedance/Reflection** button.

Hint: With a narrow receiver bandwidth like 30 Hz, the measurement is very selective. Only little noise will affect the measurement and, consequently, the measurements will be more stable but the sweep will be slow. The receiver bandwidth of 3 kHz will perform the fastest sweep.

5. Click the **Connection Setup** tab.

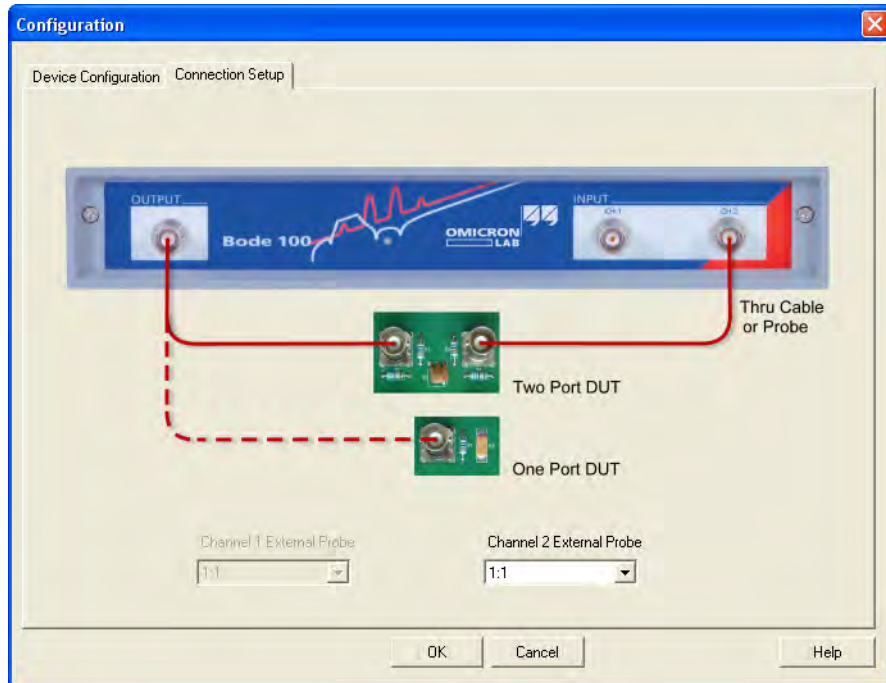

The connection diagram shows how to connect the DUT to the *Bode 100*.

Hint: Use the Channel 2 External Probe: box to set the voltage ratio when you use a probe instead of cable connection (see 10.9 "Using Probes" on page 171).

6. Connect the quartz filter to the *Bode 100* as shown.



7. Click to close the **Configuration** window and to get back to the **Frequency Sweep** mode window.

8. Set the sweep frequencies:

- Start frequency: 11.98 MHz
- Stop frequency: 12.04 MHz
- Number of points: 401

The other settings will be automatically calculated and the **Sweep** area of the **Frequency Sweep** mode window should now look like below.

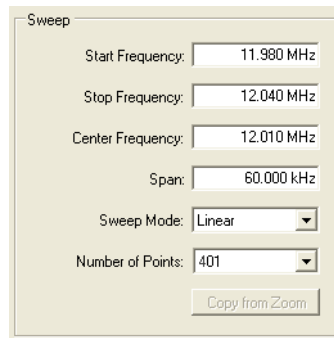

Hint: A setting which results in an out-of-range frequency for any other parameter will be corrected to ensure that all sweep frequencies (start, stop, center) are within the range of 10 Hz...40 MHz or 1 Hz...40 MHz if you selected the extended measurement range (see 9.2 "Setting the Measurement Range" on page 120).

9. Set the reference resistance.
Default: 50 Ω

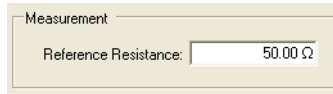

Hint: The reference resistance is used to calculate the reflection coefficient and the VSWR.

10. Activate both traces and set the parameters as shown below.

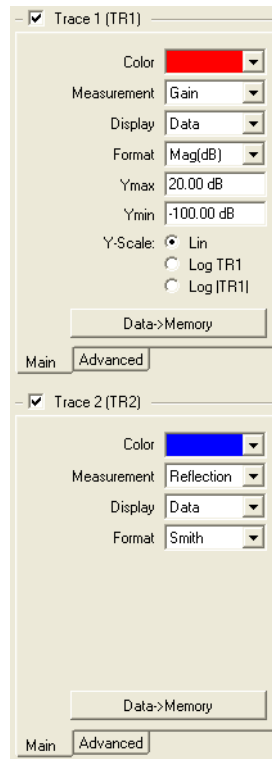

11. If you have a larger screen you can adjust your window size. Move the mouse to the lower right corner of the window  and drag the corner.

Hint: In addition to resizing the window, you can click the split bar to hide the left and right panes to increase the size of the diagrams.

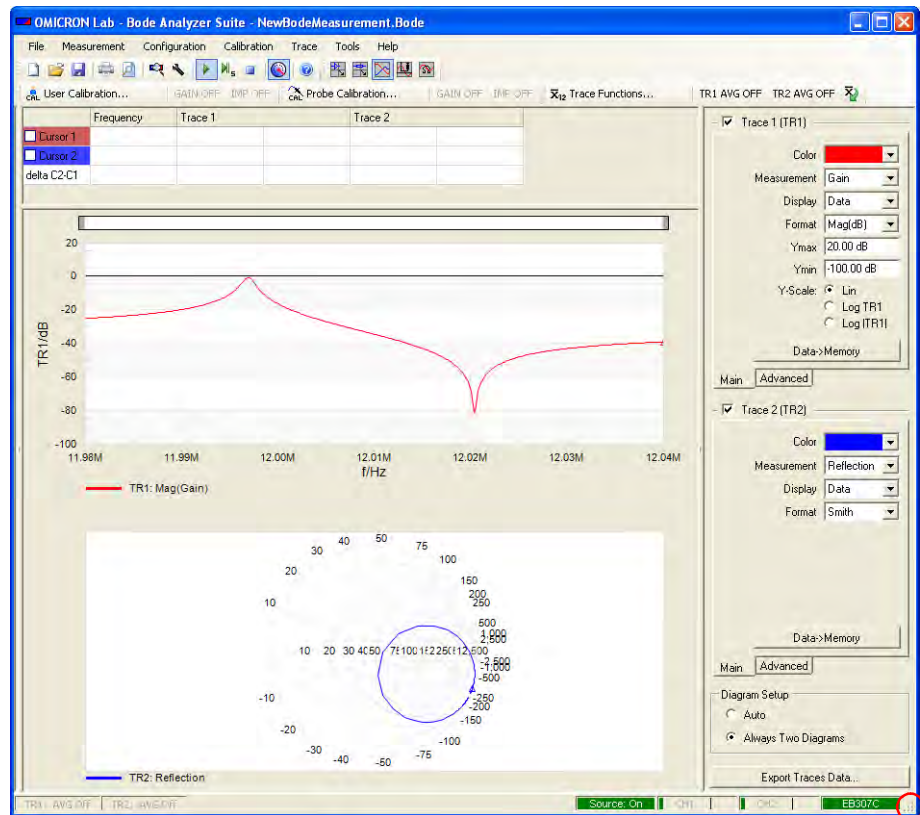

In the upper graph you see the gain of the quartz filter. You can use the cursors to measure the series and parallel resonance frequencies.

12. Select the **Cursor 1** and **Cursor 2** check boxes to activate the cursors.

13. To find the series resonance frequency of the quartz filter, right-click the curve in the upper diagram, point to **Cursor 1**, and then click **Jump to Max**.

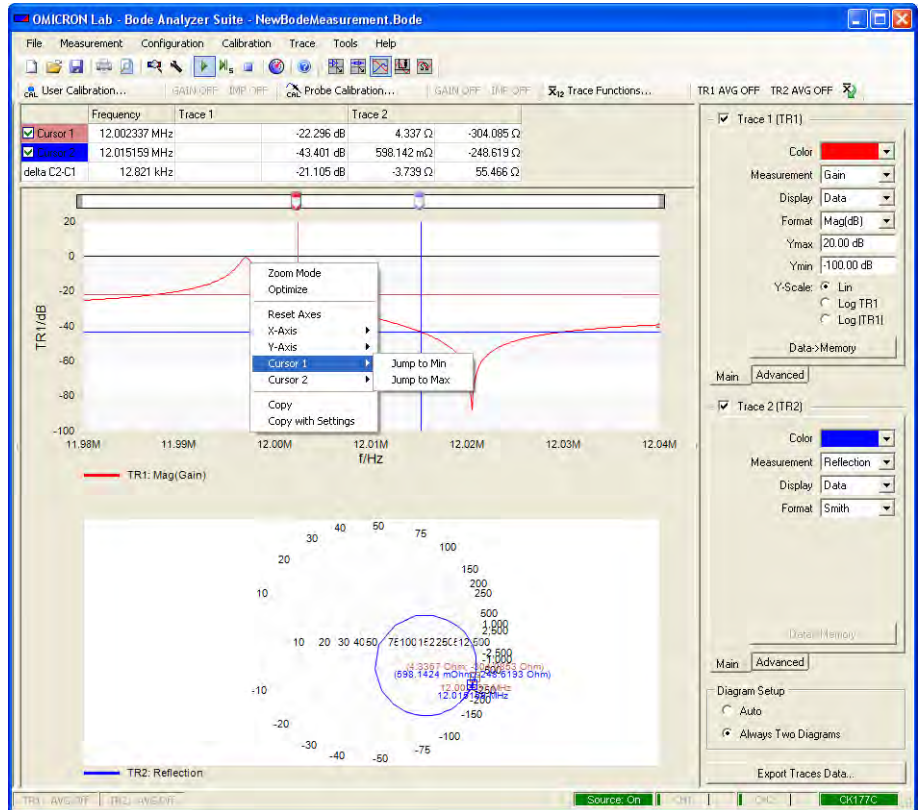

14. To find the parallel resonance frequency of the quartz filter, right-click the curve in the upper diagram, point to **Cursor 2**, and then click **Jump to Min**. In the marked area of the **Frequency Sweep** mode window, the series and parallel resonance frequencies and the corresponding measurement data are now displayed.

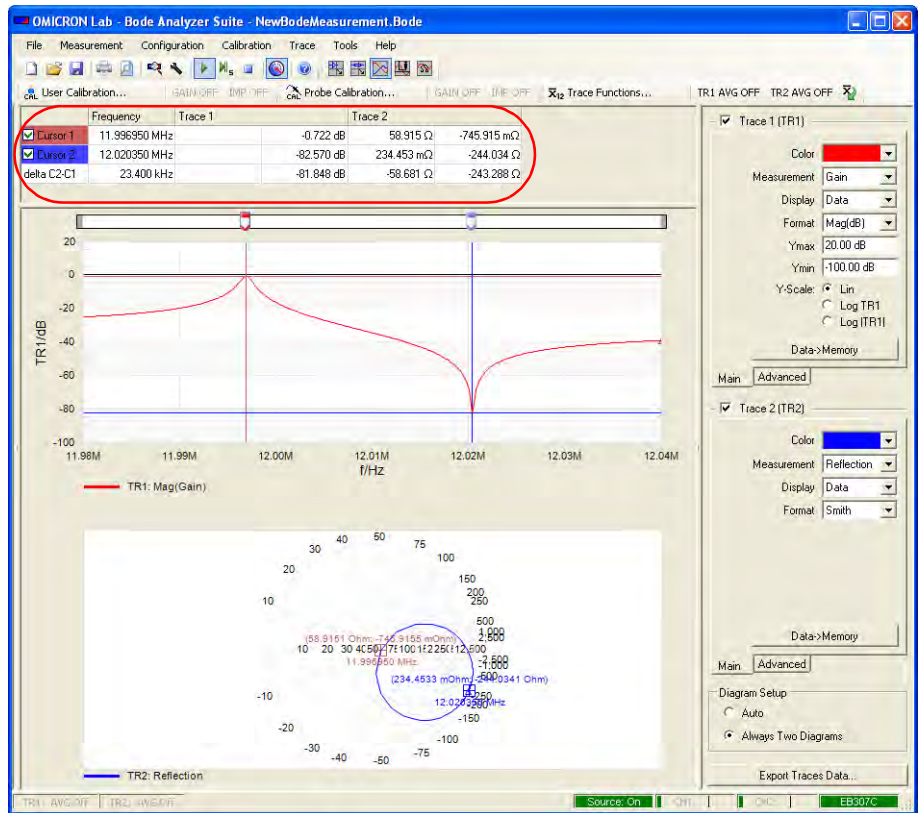

Results: Cursor 1 marks the series resonance frequency of 11.997 MHz and an attenuation at the series resonance frequency of 0.722 dB. Cursor 2 marks the parallel resonance frequency of 12.020 MHz and an attenuation at the parallel resonance frequency of 81.848 dB.

15. To measure the group delay of the quartz filter at its series resonance frequency, select **T_g** in the **Format** list. The following figure shows the group delay measured by **Trace 1** at the series resonance frequency marked by cursor 1.

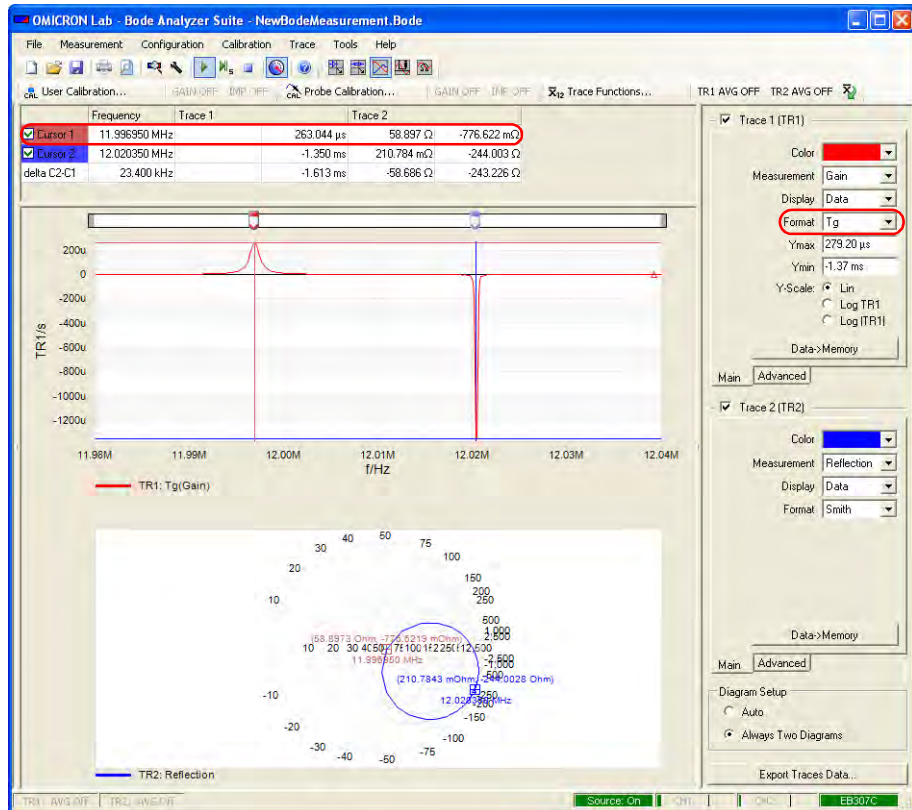

Result: The group delay T_g at the series resonance frequency of the quartz filter is 263.044 μs. Due to the high attenuation at the parallel resonance frequency it is not possible to measure the group delay at the quartz filter's parallel resonance.

Your result might be slightly different because even quartz filters show variations in their electrical characteristics.

16. For the measurement of the series resistance of the quartz filter we will use the Smith chart. The Smith chart displays the reflection coefficient (see (Eq. 4-3) on page 36) in the complex plane. The horizontal axis represents the real component and the vertical axis the imaginary component of the DUT's reflection coefficient. The central point of the Smith chart corresponds to the case when the DUT's impedance equals the reference resistance and,

consequently, the reflection coefficient is zero.

Additionally, the Smith chart contains circles with constant resistance (R) and constant reactance (X). This diagram format allows an easy "translation" of any point of the reflection coefficient curve into the corresponding DUT's impedance. The cursor values displayed in the Smith chart format are the real and imaginary components of the corresponding DUT's impedance. For more information on the Smith chart, refer to the relevant technical literature.

- In the lower graph you see the Smith chart showing the reflection coefficient of the quartz filter. To display only this chart, clear the **Trace 1** check box to deactivate trace 1.

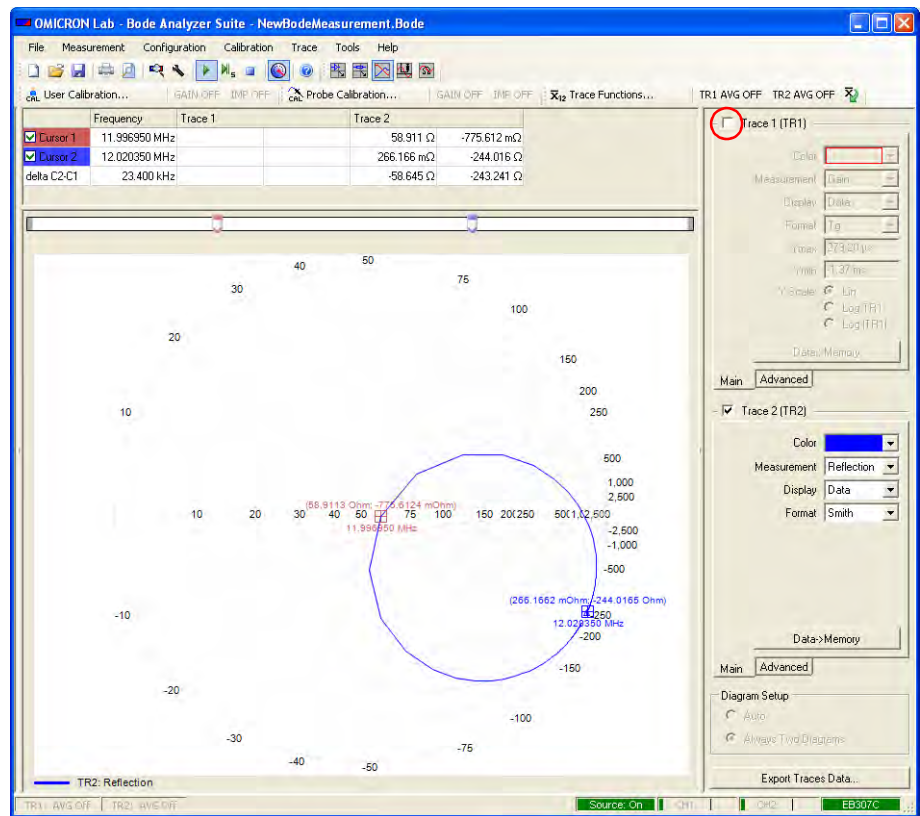

Since the output of the DUT (quartz filter) is connected to the channel 2 input, the measured impedance is the quartz impedance plus the 50 Ω input impedance of the *Bode 100*.

For an idle quartz, the trace should be nearly symmetrical against the real axis. The reason why it is not is as follows: We have used a cable to connect the quartz filter to the *Bode 100* and therefore we measure a phase shift of the reflected voltage (twice the shift of the cable itself). We can remove this

unwanted phase shift by using the **Impedance** calibration. By calibrating the *Bode 100* we move the **Impedance/Reflection** reference plane to the end of the cable connected to the input of the DUT.

5.2 Impedance Calibration

Now we perform the **Impedance** calibration. This type of calibration is also described in 8.4 "Calibration in the Impedance/Reflection Mode" on page 97.

1. Click the **Probe Calibration** toolbar button  to open the calibration window.

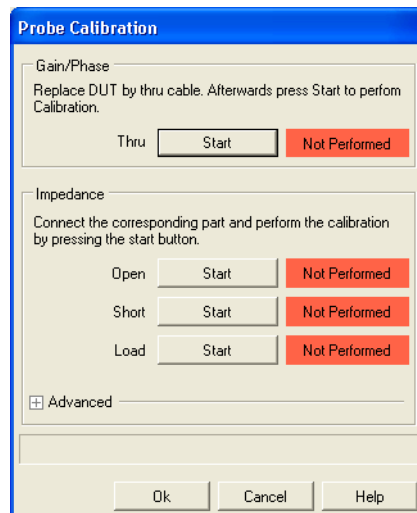

2. Connect the cable you want to use for the measurement to the OUTPUT connector of the *Bode 100*. Plug the BNC straight adapter on the other end of the cable.



- Click the **Start** button next to **Open** in the **Impedance** area of the calibration window. After the calibration has been finished, the field on the right displays **Performed** on green background.

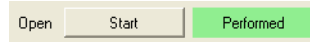

With the measurement settings the calibration may take a few seconds.

- Plug the BNC short circuit on the straight adapter connected to the cable.



- Click the **Start** button next to **Short** in the **Impedance** area of the calibration window. After the calibration has been finished, the field on the right displays **Performed** on green background.



- Replace the BNC short circuit with the BNC 50 Ω load.



- For very accurate measurements or if you use a load resistor different from 50 Ω , click the + symbol next to **Advanced**, and then enter the exact resistance of the load resistor.

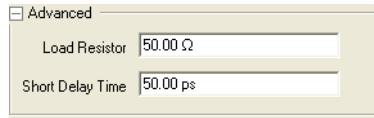

Hint: For more information on the advanced calibration settings, see 8.4 "Calibration in the Impedance/Reflection Mode" on page 97.

- Click the **Start** button next to **Load** in the **Impedance** area of the calibration window. After the calibration has been finished, the field on the right displays **Performed** on green background.



- After the calibration has been finished, the calibration window looks like shown below.

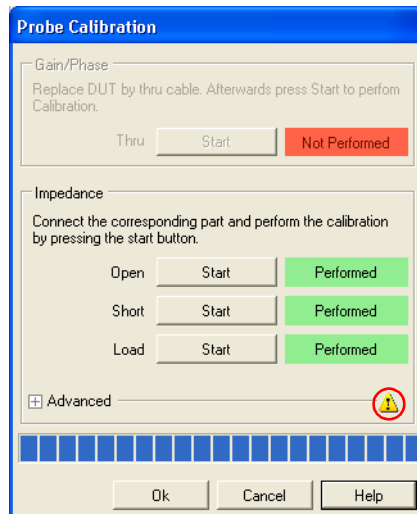

Hint: The warning symbol indicates that the load resistor and/or the short delay time value differ from the factory settings.

- Click . You have done the **Impedance** calibration in the **Frequency Sweep** mode.

11.Reconnect the quartz filter to the *Bode 100* as shown below.



12.View the calibrated Smith chart.

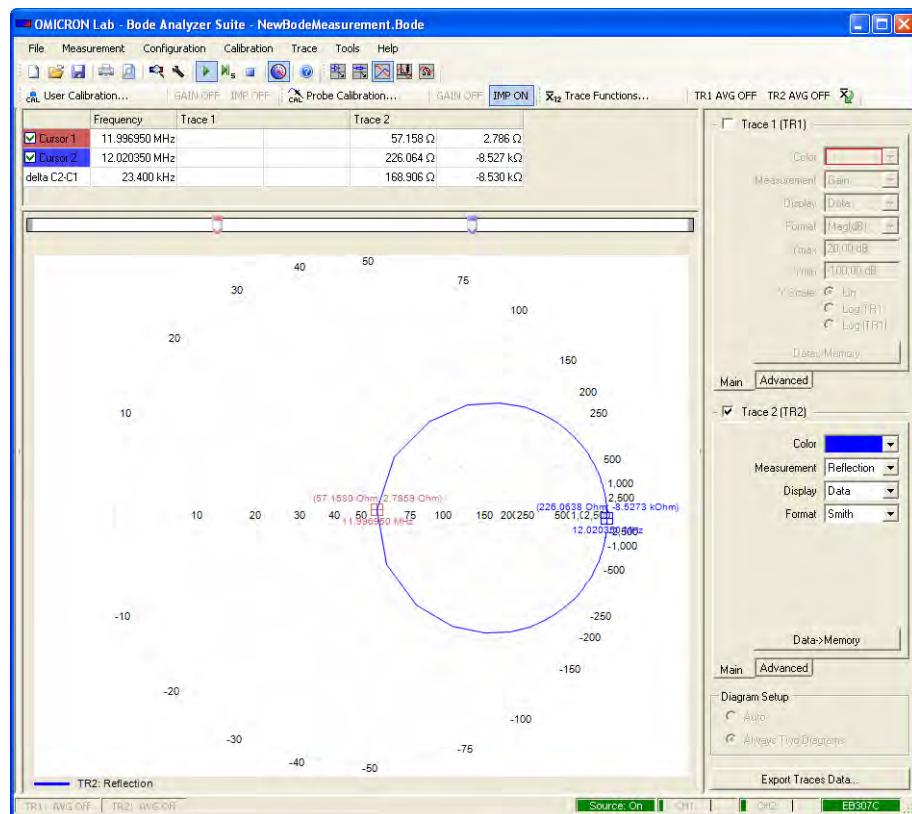

13.Calculation of the series resistance R_s at the series resonance frequency:
To calculate the series resistance of the quartz filter you need to subtract

50 Ω from the real part measured with cursor 1. The reason for this is that the reflection measurement circuit "sees" the quartz filter in series with the 50 Ω termination of the channel 2 input.

The **Trace 2** columns of the cursor table display the real and imaginary parts of the measurement results at the frequencies marked by the cursors.

Result: $R_s = 57.158 \Omega - 50 \Omega = 7.158 \Omega$

Your result may slightly differ because every quartz filter and measurement setup is different.

Congratulation! You learned how to use the **Frequency Sweep** mode.

How to:

- Visualize measurement data in a graph
- Set configuration parameters like the input resistor and bandwidth
- Set sweep parameters like start and stop frequencies
- Use cursors to read single measurement points
- Calibrate and compensate for the cable

Go back to the **Frequency Sweep** mode window in 5 "Frequency Sweep Mode" on page 47 and try things out.



Frequency sweepers have an easier time to get the picture.

6 Frequency Sweep (External Coupler) Mode

Figure 6-1:
Frequency Sweep
(External Coupler)
mode window

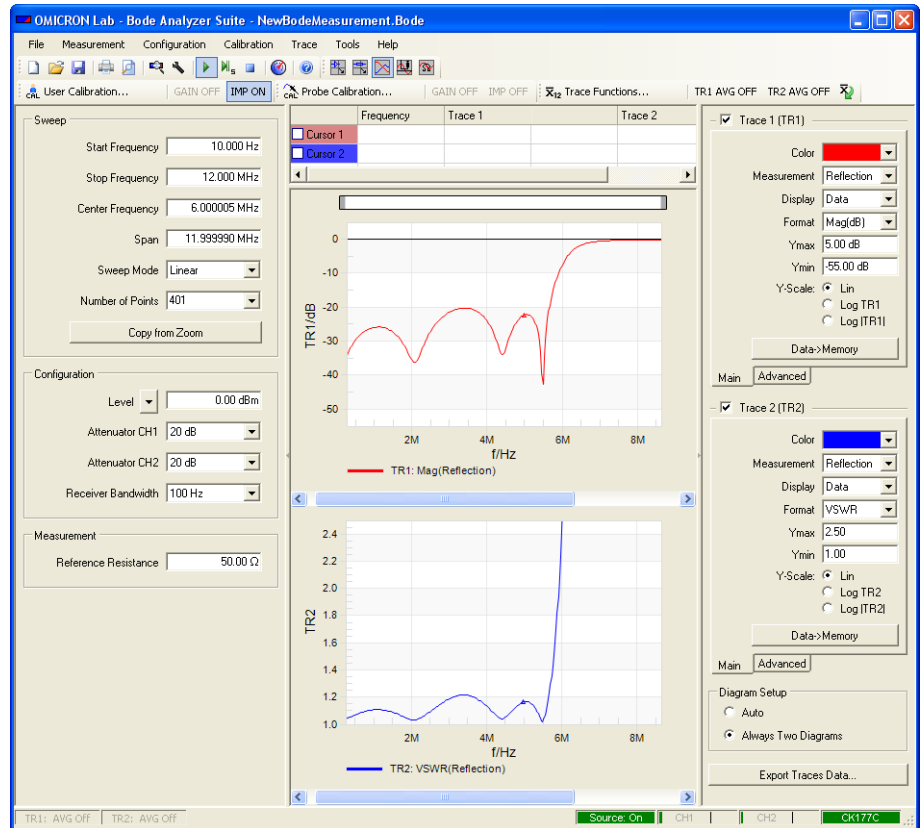

Note: The window areas and screen elements in the **Frequency Sweep (External Coupler)** mode are the same as in the **Frequency Sweep** mode. For their description, see Figure 5-1: "Frequency Sweep mode window" on page 47.



In the **Frequency Sweep (External Coupler)** mode you can perform a sequence of **Impedance/Reflection** measurements by using an external directional coupler only or in combination with an external amplifier.

For some impedance measurement applications, it is beneficial to use external couplers for an optimum adaptation of the *Bode 100* to the test object (see Figure 6-2: "Connecting external coupler" below). Further on, impedance measurements on some test objects such as medium wave antenna systems require higher signal levels than provided by the *Bode 100*. By using an external

coupler it is possible to utilize an external amplifier to boost the *Bode 100* source signal to the required output level (see Figure 6-3: "Connecting external coupler and amplifier" below).

Figure 6-2:
Connecting external
coupler

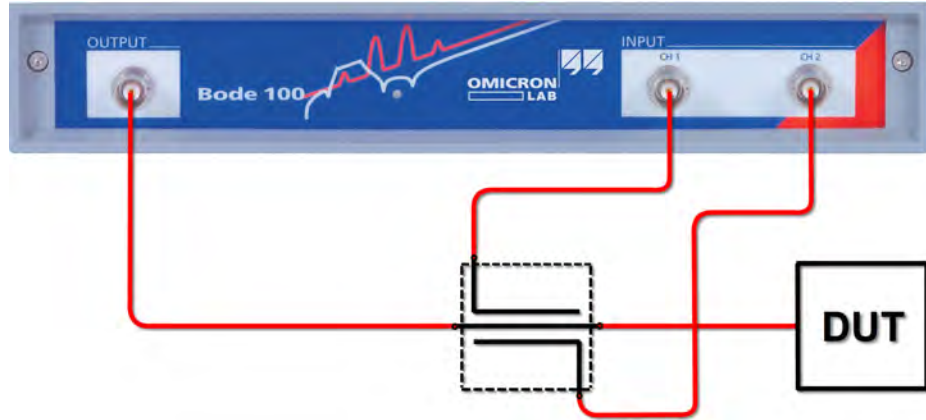
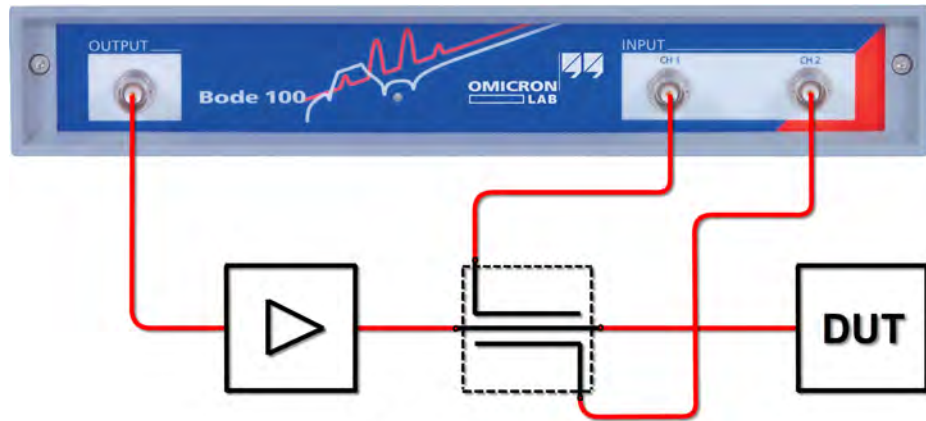

Figure 6-3:
Connecting external
coupler and amplifier



Hint: By using an external amplifier and an external coupler you can protect the *Bode 100* inputs and the source output from reverse power emitted by the DUT (e.g. radio waves received by a broadcast antenna).

6.1 Example: Frequency Sweep (External Coupler) Measurement

Expected example duration: 30 minutes.

In this example you will learn step by step how to use the **Frequency Sweep (External Coupler)** mode of the *Bode 100*.

How to:



- Connect an external coupler
- Set configuration parameters like the input resistor and bandwidth
- Calibrate and compensate the connection system
- Display reflection in VSWR format
- Display impedance in polar format
- Remove the effect of noise

Let's examine the delivered IF filter when connected to the *Bode 100* by means of a 50 Ω directional coupler.

Questions:

- What is the VSWR of the IF filter within its passband?
- How does the impedance of the IF filter look like in polar format?
- What is the exact impedance and VSWR of the filter at its center frequency of 10.7 MHz?

To find out the answers, proceed as follows:

1. Connect the *Bode 100* to the computer and start the *Bode Analyzer Suite*.
2. Click the **Frequency Sweep (External Coupler)** toolbar button  to switch to the **Frequency Sweep (External Coupler)** mode.
3. Click the **Device Configuration** toolbar button  to configure the **Frequency Sweep (External Coupler)** mode.

4. Set:

- SOURCE: On or Auto
- CH1: 50 Ω ON
- CH2: 50 Ω ON

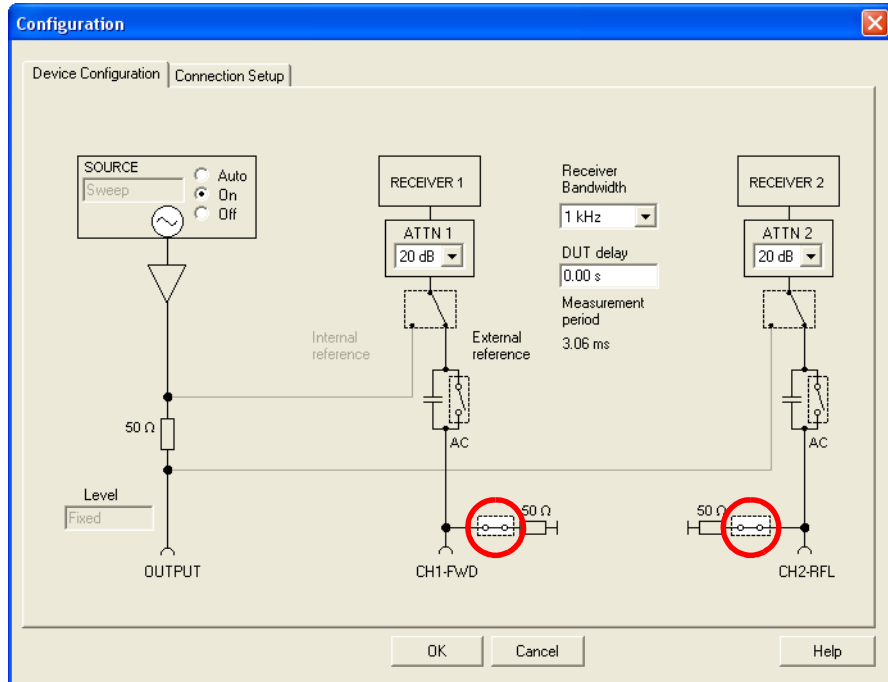

Hint: To match the impedance of the directional coupler, the input resistances of the channel 1 (CH1) and channel 2 (CH2) are set to 50 Ω .

- Click the **Connection Setup** tab.

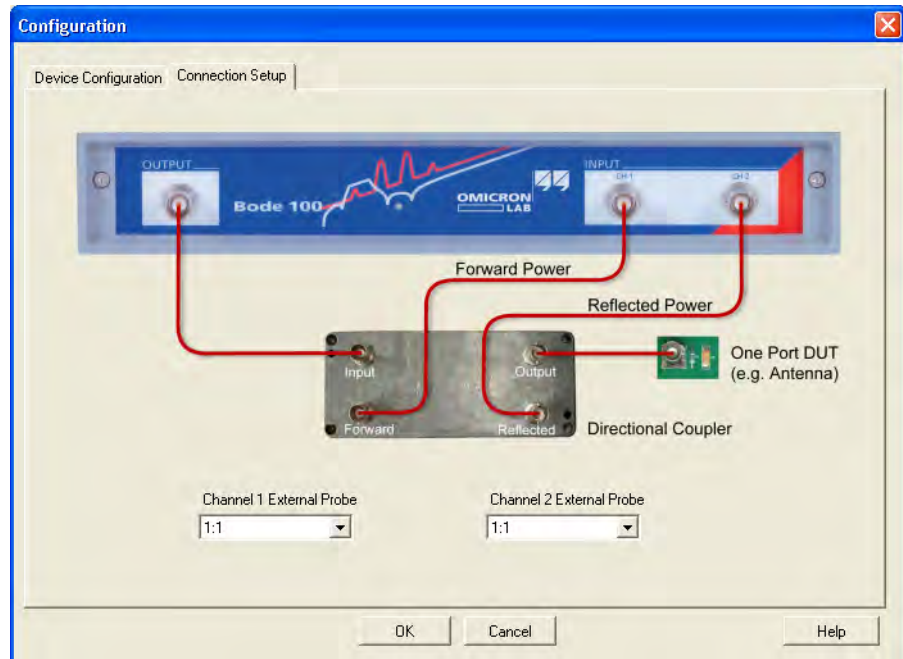

The connection diagram shows how to connect the DUT as well as the directional coupler to the *Bode 100*.

6. Connect the directional coupler to the *Bode 100* as shown.



7. Click to close the **Configuration** window and to get back to the **Frequency Sweep (External Coupler)** mode window.

8. Set the sweep frequencies:
- Start frequency: 8.7 MHz
 - Stop frequency: 12.7 MHz
 - Number of points: 201

The other settings will be automatically calculated and the **Sweep** area of the **Frequency Sweep (External Coupler)** mode window should now look like below.

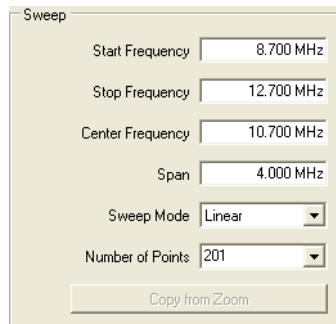

9. Set the reference resistance.

Default: 50 Ω

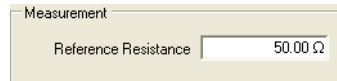

Hint: The reference resistance is used to calculate the reflection coefficient and the VSWR.

10. Calibrate the measurement setup as described in 8.6 "Calibration in the Frequency Sweep (External Coupler) Mode" on page 106.

Hint: Due to the strongly varying parameters of directional couplers a calibration is mandatory before performing a measurement. If you start a measurement in the **Frequency Sweep (External Coupler)** mode without calibration, the following dialog box appears.

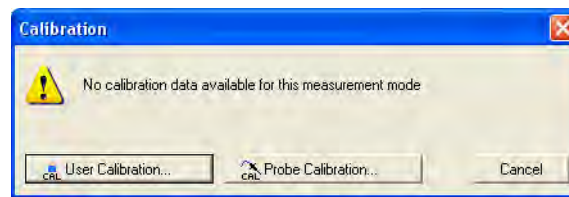

In this case, select the **User Calibration** or the **Probe Calibration**, and then proceed as described in 8.6 "Calibration in the Frequency Sweep (External Coupler) Mode" on page 106.

11. Connect the IF Filter to the *Bode 100* and the 50 Ω load to the output of the IF filter as shown below.



12. Activate both traces and set the parameters as shown below.

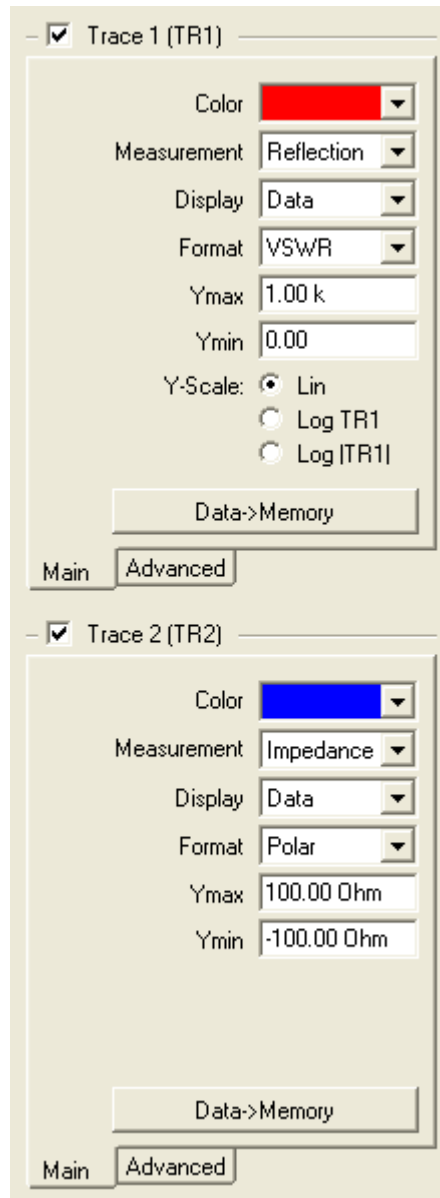

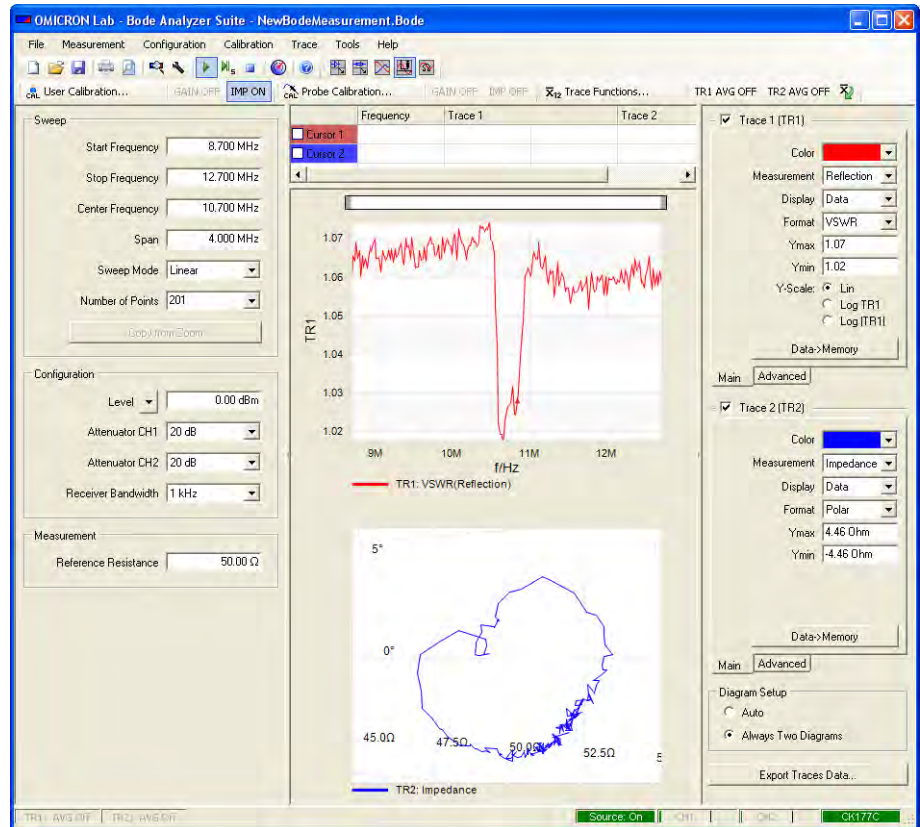

In the upper graph you see the reflection of the IF filter in VSWR format. Even outside its passband the VSWR of the filter is quite good – this indicates that the input impedance of the filter in the measured frequency range is very close to 50 Ω in general. The lower graphs shows the impedance of the IF filter in polar format, the so-called polar curve.

Hint: The effect of noise on the measurement results can be reduced by narrowing the receiver bandwidth, by using less attenuation in the input channels and by increasing the signal level of the *Bode 100* source output.

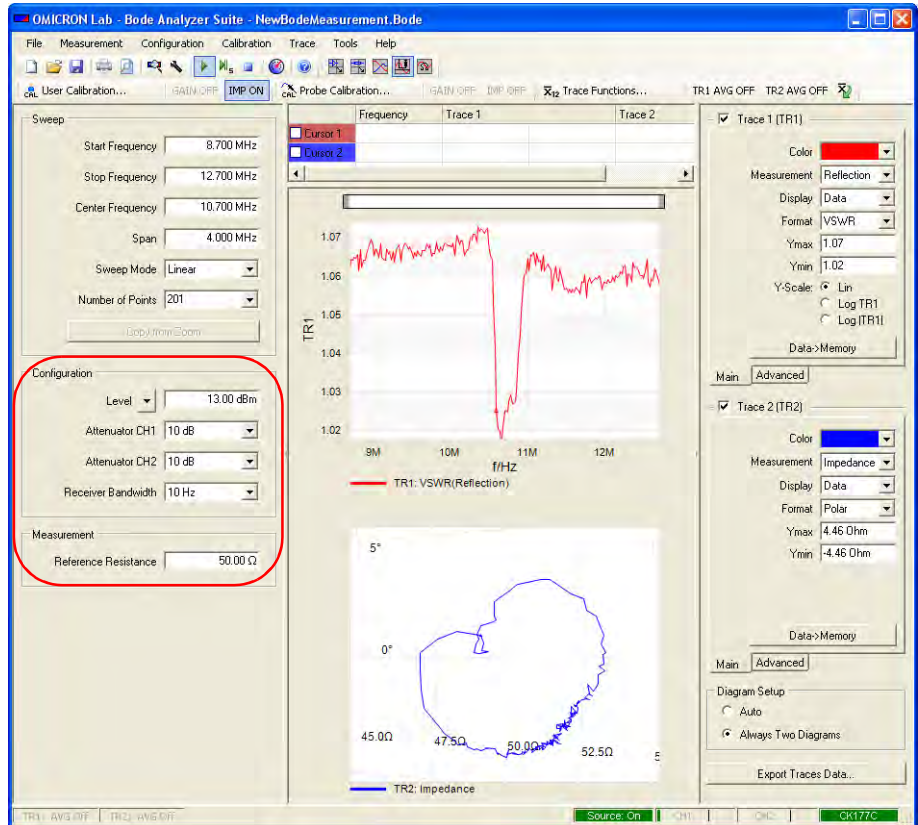

13. Select the **Cursor 1** check box to activate the cursor, and then set the cursor to the IF filter's center frequency of 10.7 MHz by entering 10.7 MHz in the respective box of the cursor table.

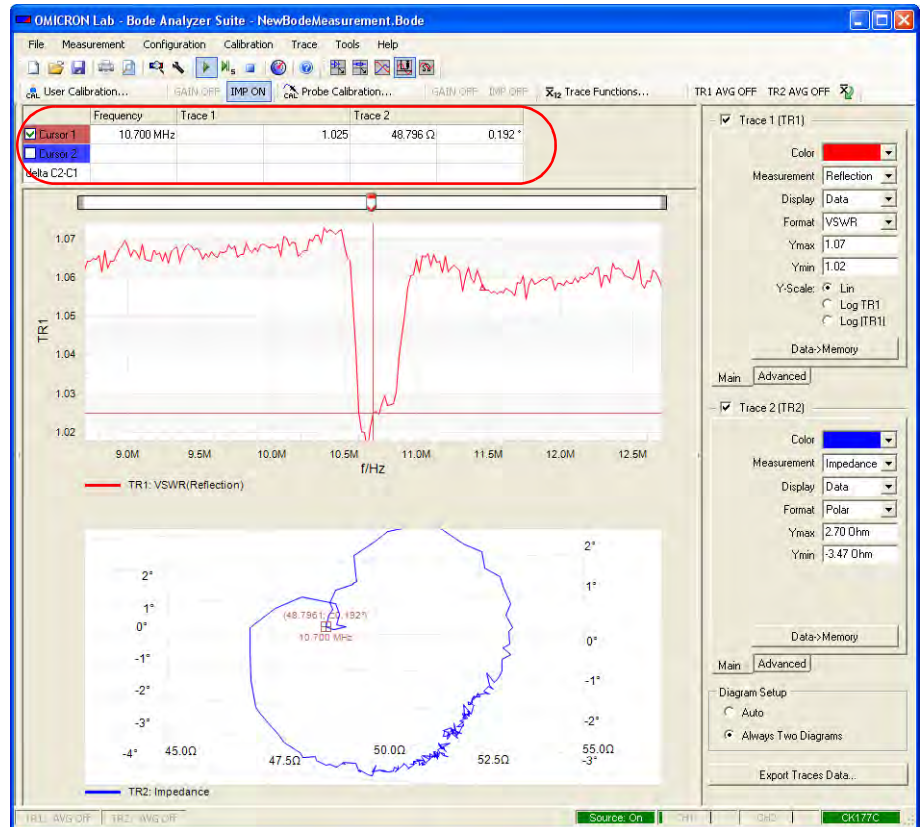

Result: The VSWR of the IF filter at its center frequency is 1.025. The impedance graph shows an impedance of 48.796 Ω and due to the very small positive phase shift a nearly pure resistive behavior.



Sometimes external couplers help to make a match and to enhance the power.

Congratulation! You learned how to use the **Frequency Sweep (External Coupler)** mode.

How to:

- Connect an external coupler
- Set configuration parameters like the input resistor and bandwidth
- Calibrate and compensate the connection system
- Display reflection in VSWR format
- Display impedance in polar format
- Remove the effects of noise

Go back to the **Frequency Sweep (External Coupler)** window in 6 "Frequency Sweep (External Coupler) Mode" on page 67 and try things out.

7 Frequency Sweep (Impedance Adapter) Mode

Figure 7-1:
Frequency Sweep
(Impedance Adapter)
mode window

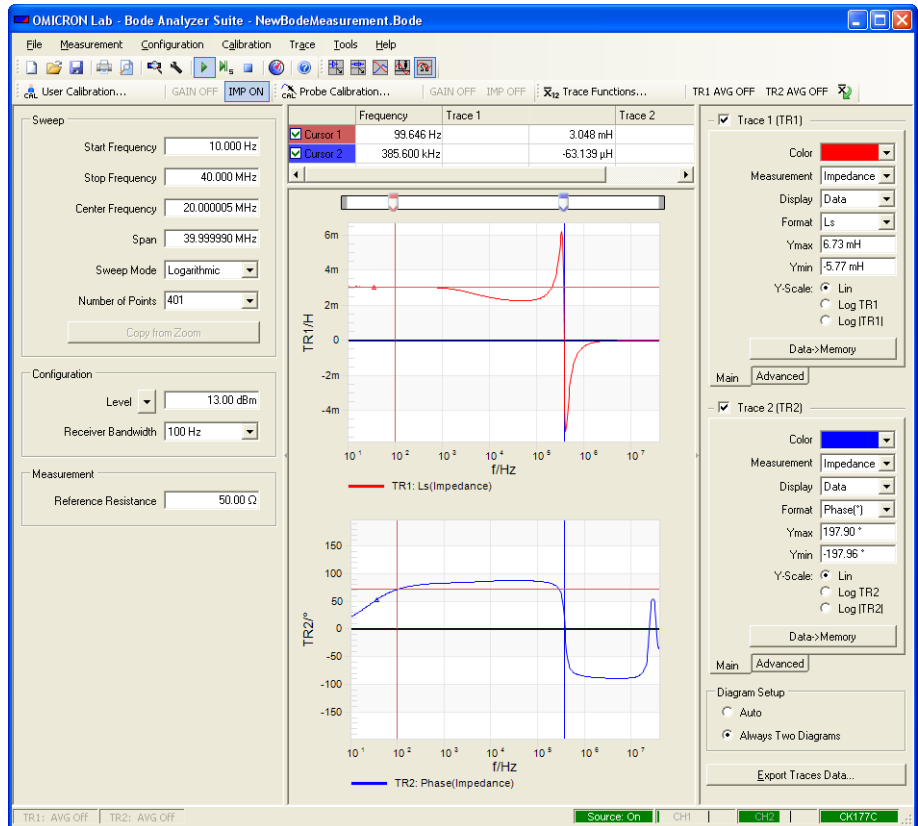

Note: The window areas and screen elements in the **Frequency Sweep (Impedance Adapter)** mode are the same as in the **Frequency Sweep** mode. For their description, see Figure 5-1: "Frequency Sweep mode window" on page 47.



In the **Frequency Sweep (Impedance Adapter)** mode, you can perform a sequence of **Impedance/Reflection** measurements and get a better grip on your electronic components by using OMICRON Lab impedance adapters for the *Bode 100* (see 1.8 "Additional Accessories" on page 15).

The impedance adapters contain a special circuitry which extends the impedance measurement range of the *Bode 100*. By using the adapters, you can quickly measure electronic components in various mounting forms. The

B-WIC adapter facilitates measuring of all wired passive components while the B-SMC adapter is especially designed for connecting even smallest SMD components.

7.1 Example: Frequency Sweep (Impedance Adapter) Measurement

Expected example duration: 30 minutes.

In this example you will learn step by step how to use the **Frequency Sweep (Impedance Adapter)** mode of the *Bode 100*.

How to:



- Connect the impedance adapters
- Set configuration parameters like the start and stop frequencies and the bandwidth
- Calibrate and compensate the connection system
- Display the series inductance in Henry
- Display the series resistance in double logarithmic scale

Let's examine the impedance behavior of a wired coil.

Questions:

- What is the frequency range the coil can be used in?
- Does the coil become capacitive and, if yes, where is its resonance frequency?
- Does the coil have a series or a parallel resonance?
- What is the coil's series resistance?

To find out the answers, proceed as follows:

1. Connect the *Bode 100* to the computer and start the *Bode Analyzer Suite*.
2. Click the **Frequency Sweep (Impedance Adapter)** toolbar button  to switch to the **Frequency Sweep (Impedance Adapter)** mode.
3. Click the **Device Configuration** toolbar button  to configure the **Frequency Sweep (Impedance Adapter)** mode.
4. Select the receiver bandwidth: 100 Hz

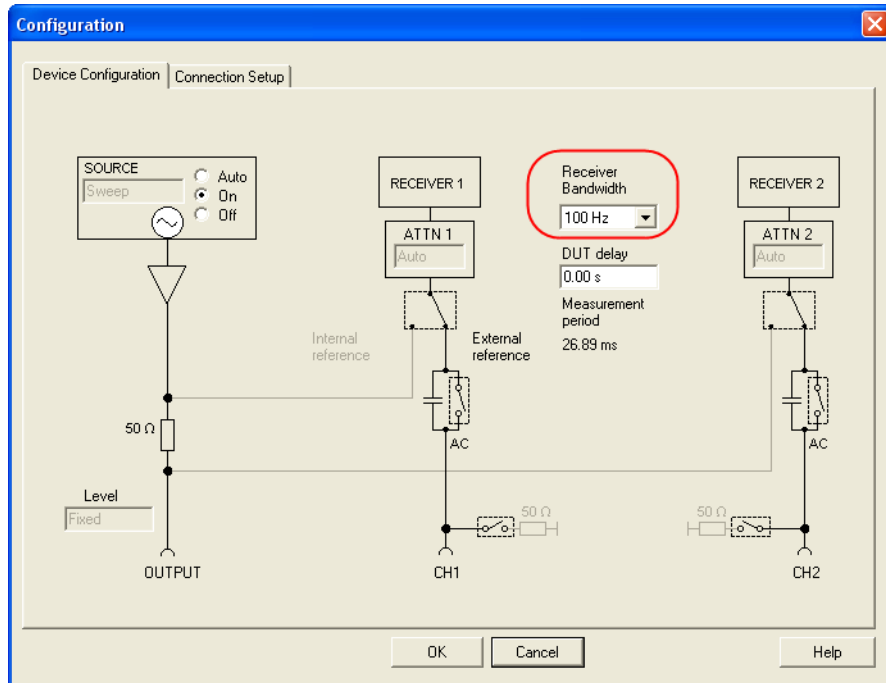

Hint: To ensure a wide measurement range the input impedances of the channel 1 (CH1) and channel 2 (CH2) are set to high impedance.

5. Click the **Connection Setup** tab.

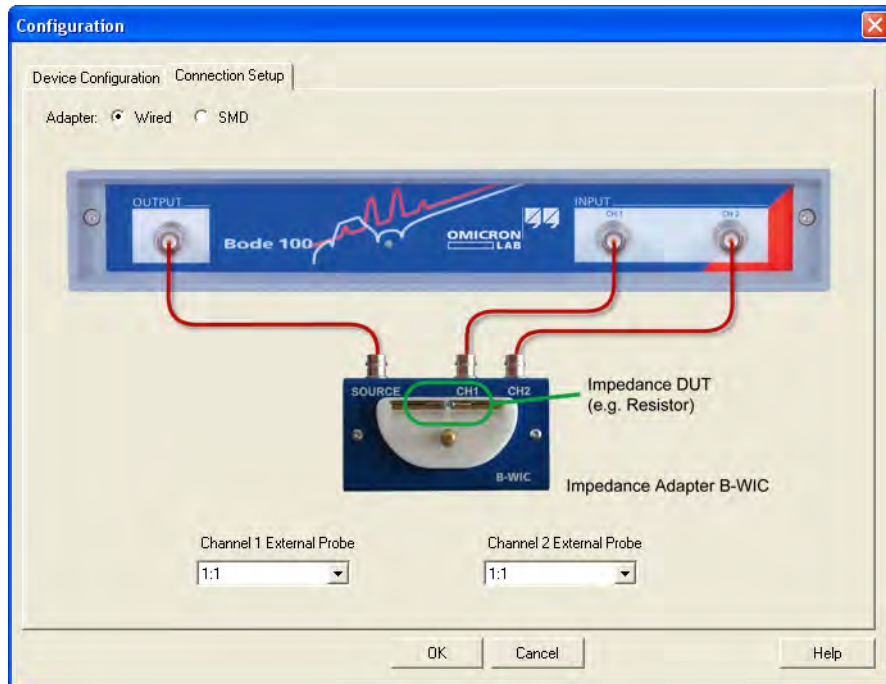

6. The connection diagram shows how to connect the impedance adapter to the *Bode 100*. Click **Wired** for connecting a wired component.
7. Connect the B-WIC impedance adapter to the *Bode 100* as shown in the following figure.

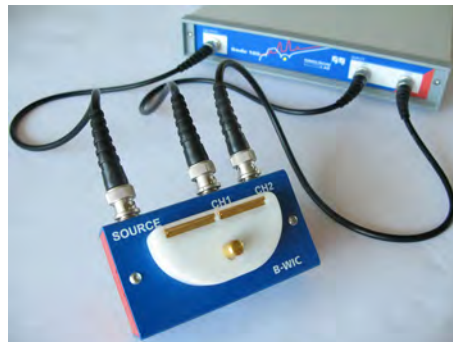

8. Click to close the **Configuration** window and to get back to the **Frequency Sweep (Impedance Adapter)** mode window.

9. Set the sweep frequencies:

- Start frequency: 10 Hz
- Stop frequency: 40 MHz
- Sweep mode: logarithmic
- Number of points: 401

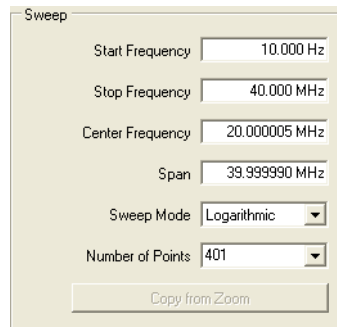

10. Calibrate the measurement setup as described in 8.7 "Calibration in the Frequency Sweep (Impedance Adapter) Mode" on page 110.

Hint: To compensate the impedance of the measurement circuitry inside the impedance adapter a calibration is mandatory before performing a measurement. If you start a measurement in the **Frequency Sweep (Impedance Adapter)** mode without calibration, the following dialog box appears.

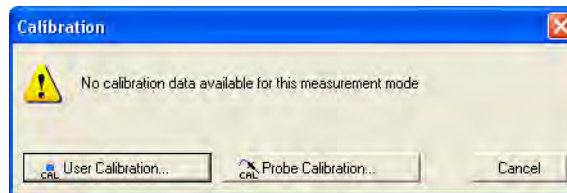

In this case, select the **User Calibration** or the **Probe Calibration**, and then proceed as described in 8.7 "Calibration in the Frequency Sweep (Impedance Adapter) Mode" on page 110.

11. Now, connect the DUT to the adapter's connectors as shown in the following figure.

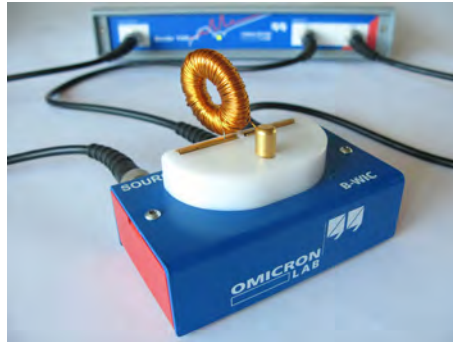

12. Activate both traces and set the parameters as shown in the following figure.

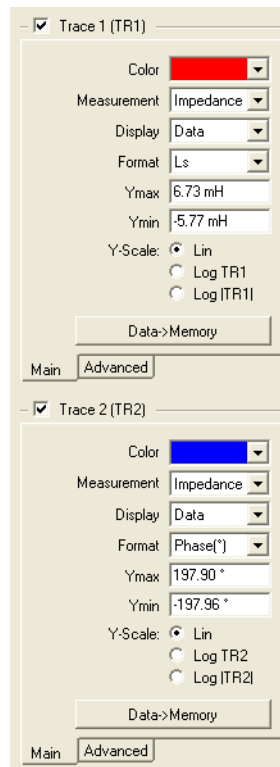

13. Select the **Cursor 1** and **Cursor 2** check boxes to activate the cursors for analyzing the measurement curve.

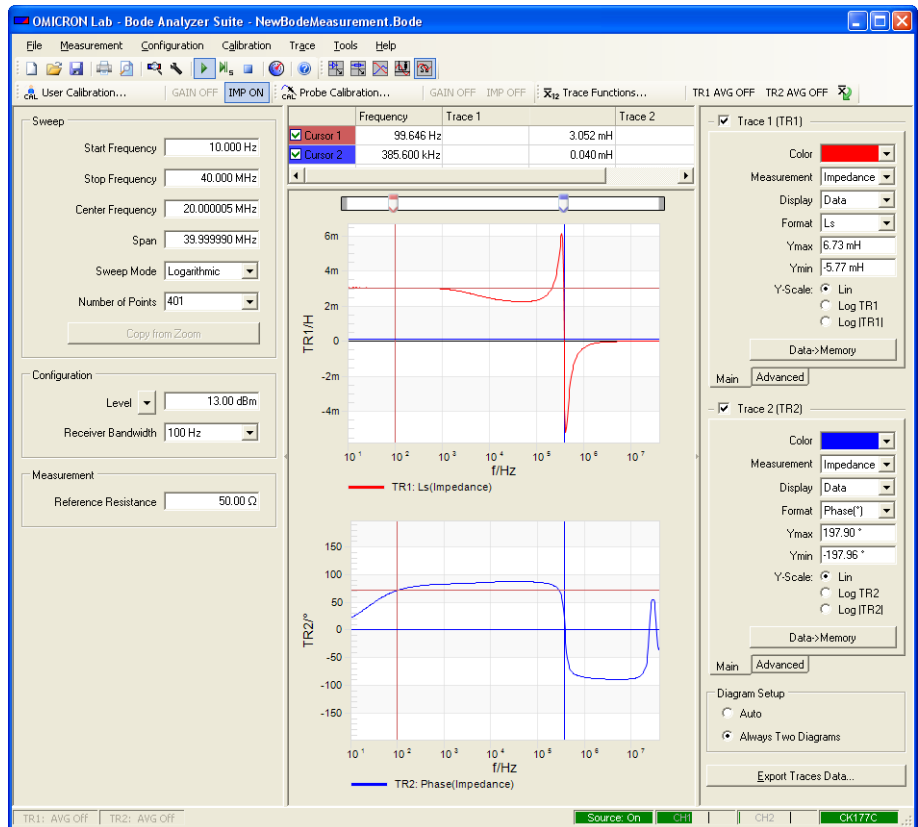

In the upper graph you see the serial inductance of the coil. At lower frequencies the serial inductance is around 3 mH. The graph shows that the inductance starts decreasing at a frequency around 1 kHz and shows a resonance at 385.6 kHz. For frequencies higher than the resonance frequency, the coil has a capacitive behavior except within a small frequency range where it gets inductive again. This indicates a parallel resonance as the inductance is active for low frequencies, while the capacitive part is active for high frequencies. The small inductive range between 24.5 MHz and 35.1 MHz is easily visible in the phase curve of the coil shown in the lower graph.

14. Now, switch the format of trace 1 to **Rs** to measure the series resistance of the coil.

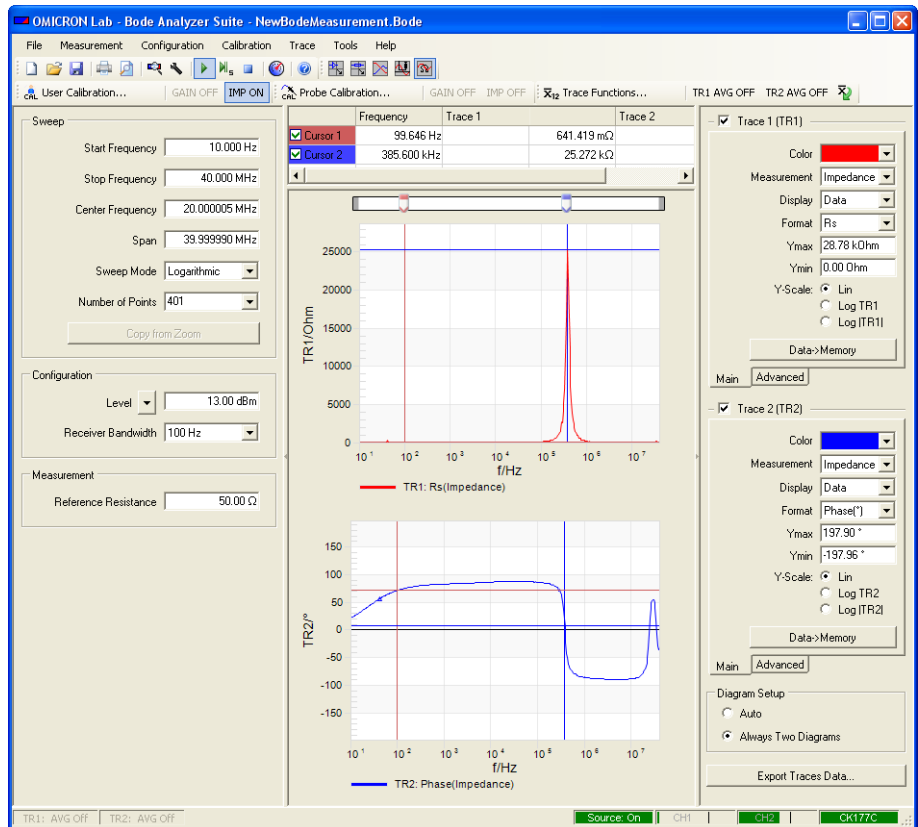

Hint: The series resistance shown in the upper graph shows a very high resistance at the resonance frequency. But due to the linear scaling the graph does not show any detailed information for the rest of the curve. Therefore we now set the scaling for the Y-axis to logarithmic.

- In the trace settings area of the *Bode Analyzer Suite* window, click **Log TR1** to display the graph in the logarithmic Y-axis scale.

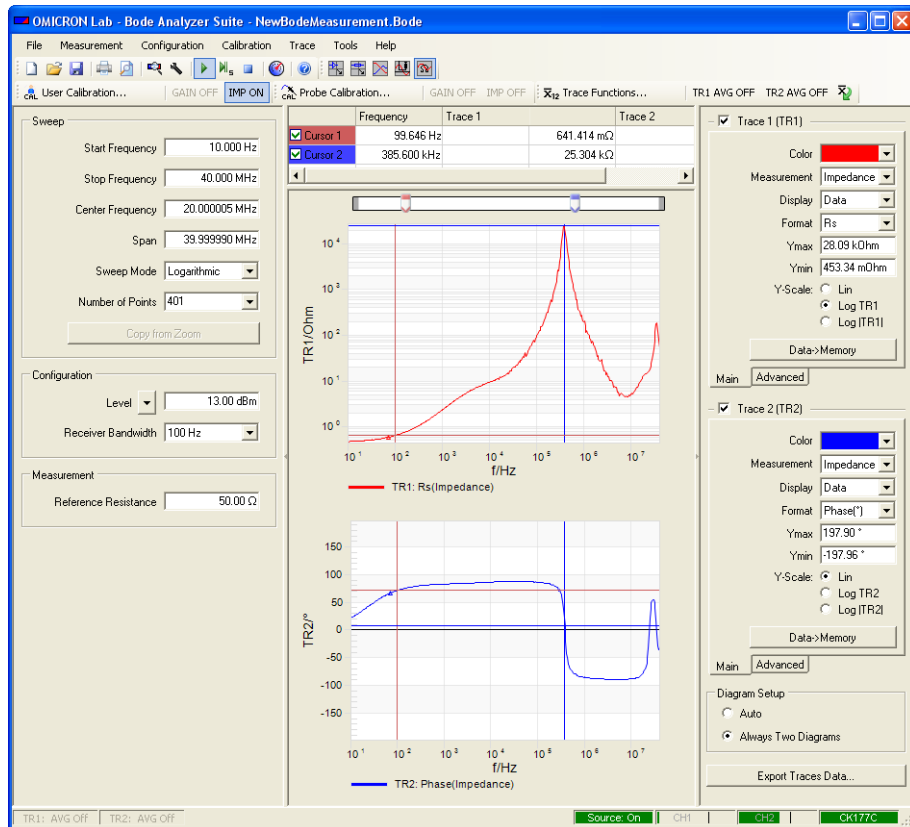

Result: In the upper graph you can now see a better graph of the series resistance. Due to the logarithmic Y-axis scaling, the graph clearly shows that the series resistance continuously rises until the maximum resistance is reached at the resonance frequency. You can also see that after dropping the series resistance increases again in the high-frequency range in which the coil shortly becomes inductive again.



If you adapt yourself to components you can characterize them more easily.

Congratulation! You learned how to use the **Frequency Sweep (Impedance Adapter)** mode.

How to:

- Connect an impedance adapter
- Calibrate and compensate the connection system
- Display the series inductance in Henry
- Display the series resistance in double logarithmic scale

Feel free to go back to the **Frequency Sweep (Impedance Adapter)** window in 7 "Frequency Sweep (Impedance Adapter) Mode" on page 79 and try things out.

8 Calibrating the *Bode 100*

The *Bode 100* can compensate effects of the measurement setup like cables and probes. Further on the overall accuracy may be improved by calibrating the *Bode 100* (e.g. if the operating temperature is outside the range specified in 13.5 "Environmental Requirements" on page 183).

8.1 Calibration Methods

The *Bode 100* supports two calibration methods: the **Probe Calibration** optimized for measurements which require frequent changes of measurement settings and the **User Calibration** for most accurate results.

Note: During startup, the *Bode 100* executes an **Internal Calibration** algorithm. During this calibration, internal attenuators and amplifiers are measured and calibrated.

8.1.1 Probe Calibration



The **Probe Calibration** of the *Bode 100* allows you to change several measurement parameters without the need of recalibration. During the **Probe Calibration**, calibration factors are determined at factory defined frequencies within the complete frequency range. The calibration factors for the frequency points used by the current measurement settings are then obtained by linear interpolation.

Hint: The **Probe Calibration** compensates effects of cables and broad-band probes. If you want to compensate frequency selective probes or if your cable length exceeds 10 m it is recommended to use the **User Calibration** (see 8.1.2 "User Calibration" on page 90).

The **Probe Calibration** allows **changing** the following parameters **without the need of recalibrating** the *Bode 100*:

- Frequency values
- Sweep mode (linear/logarithmic)
- Number of measurement points (in the **Frequency Sweep** modes)
- Source level
- Attenuator 1 and attenuator 2
- Receiver bandwidth
- Zoom **with & without** the **Copy from Zoom** function (see "Copy from Zoom" on page 131)

The **Probe Calibration** will be **switched off automatically** if the following parameters are changed:

- Reference mode (internal/external reference)
- Conversion ratio of external probes (see 10.9 "Using Probes" on page 171)
- Input resistance of channel 1 and/or channel 2 (low/high impedance)

Hint: Use the **Probe Calibration** if measurement parameters have to be changed often during the measurements. You will save time because you do not need to recalibrate the *Bode 100* each time you changed the parameters.

8.1.2 User Calibration

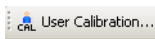

The **User Calibration** is the most accurate calibration method available with the *Bode 100*. The **User Calibration** is performed directly at the exact measurement frequencies. In the **Gain/Phase** and **Impedance/Reflection** measurement modes, the *Bode 100* is calibrated at the source frequency. In the **Frequency Sweep** modes, the calibration is performed at the exact frequencies specified by the measurement points.

The **User Calibration** allows **changing** the following parameters **without the need of recalibrating** the *Bode 100*:

- Source level
- Attenuator 1 and attenuator 2
- Receiver bandwidth
- Zoom **without** the **Copy from Zoom** function (see "Copy from Zoom" on page 131)

The **User Calibration** will be **switched off automatically** if one of the following parameters is changed:

- Frequency values
- Sweep mode (linear/logarithmic)
- Number of measurement points (in the **Frequency Sweep** modes)
- Reference mode (internal/external reference)
- Conversion ratio of external probes (see 10.9 "Using Probes" on page 171)
- Input resistance of channel 1 and/or channel 2 (low/high impedance)
- Zoom **with** the **Copy from Zoom** function (see "Copy from Zoom" on page 131)

Hint: Use the **User Calibration** for the highest accuracy of measurement results or if you want to compensate for highly frequency selective components in your measurement setup such as narrow-band measurement probes.

8.1.3 Hierarchy of Calibration Methods

The following table gives an overview of the *Bode 100* calibration methods.

Table 8-1:
Calibration methods

Measurement Mode	User Calibration	Probe Calibration
Gain/Phase	Calibrates at only one frequency (measurement frequency)	Calibrates the complete frequency range. Calibration factor for the measurement frequency is calculated by linear interpolation.
Impedance/Reflection		
Frequency Sweep	Calibrates at the exact frequency points used for the sweep	Calibrates the complete frequency range. Calibration factors for the measurement frequencies are calculated by linear interpolation.
Frequency Sweep (External Coupler)		
Frequency Sweep (Impedance Adapter)		

You can activate the **User Calibration** and the **Probe Calibration** at the same time as shown below.

Figure 8-1:
Activating
User Calibration and
Probe Calibration



If both the **User Calibration** and the **Probe Calibration** are activated, the more accurate **User Calibration** is used. If measurement parameters are changed and the **User Calibration** becomes void the *Bode 100* switches automatically to the **Probe Calibration**; the **User Calibration** remains switched off until the *Bode 100* is recalibrated.

8.2 Calibration in the Gain/Phase Mode (Internal Reference Connection)

For calibrating the *Bode 100* in the **Gain/Phase** mode you find a practical example in 3.3 "Example: Gain/Phase Measurement" on page 26.

Note: The **Probe Calibration** is performed in the same way as the **User Calibration**.

8.3 Calibration in the Gain/Phase Mode (External Reference Connection)

To compensate for the cable and connection setup effects in the **Gain/Phase** mode, proceed as follows:

1. Connect the *Bode 100* and start the *Bode Analyzer Suite*.
Select the **Gain/Phase** mode.

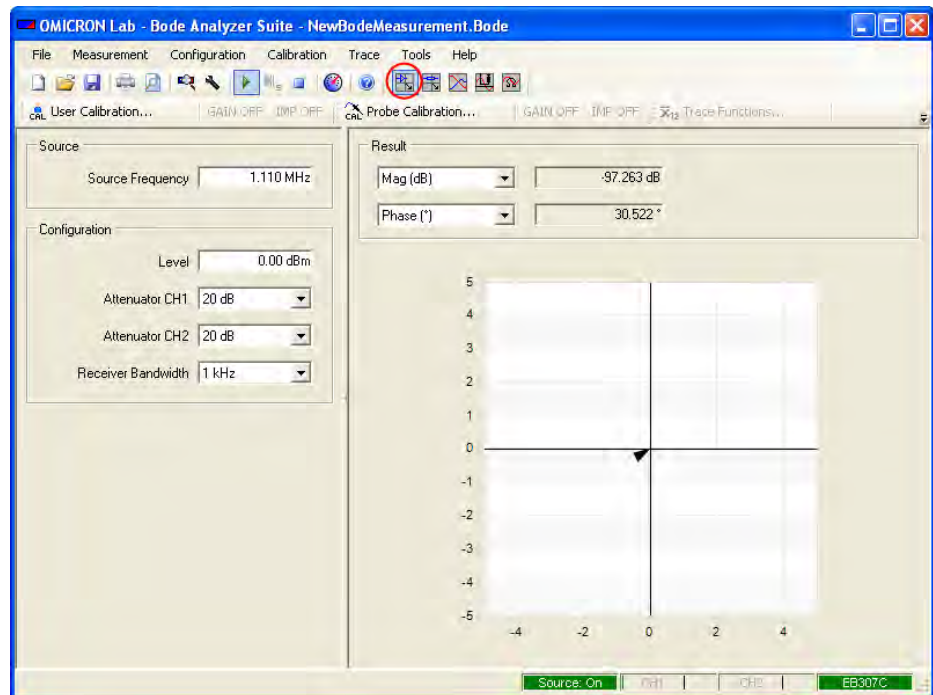

2. Click the **Device Configuration** toolbar button  to open the **Configuration** window.
In the **Configuration** window, set the parameters for your measurement. In our example we have chosen the following settings.

3. Set:

- External reference CH1 (Click the switch symbol )
- CH1 and CH2: 50 Ω (Click the switch symbols.)

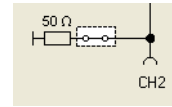
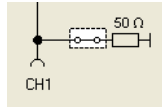

- SOURCE: 10.7 MHz
- SOURCE: On or Auto
- Receiver bandwidth: 10 Hz
- ATTN 1: 20 dB
- ATTN 2: 20 dB
- Level: 0 dBm

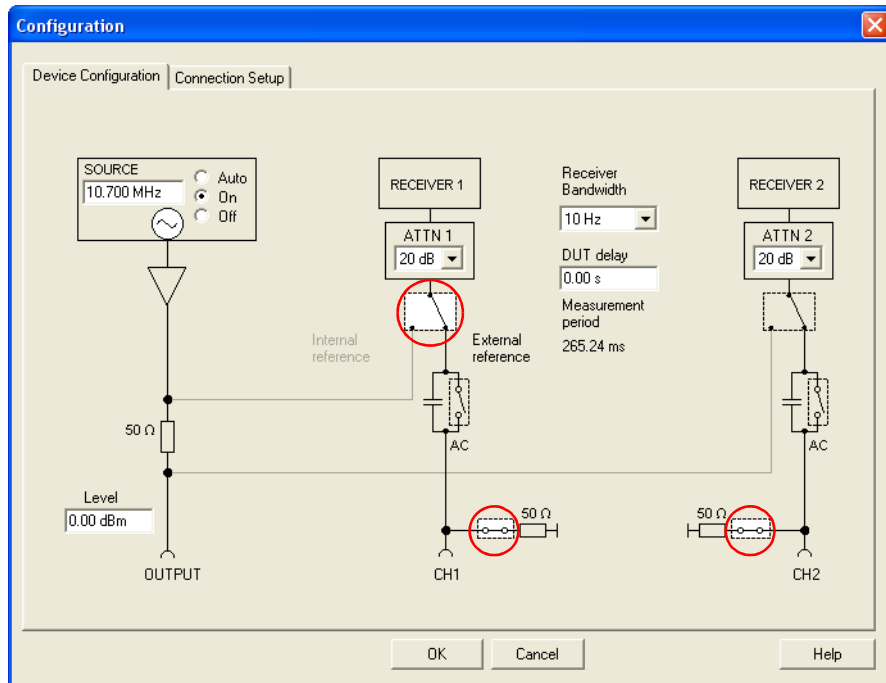

- Click the **Connection Setup** tab.

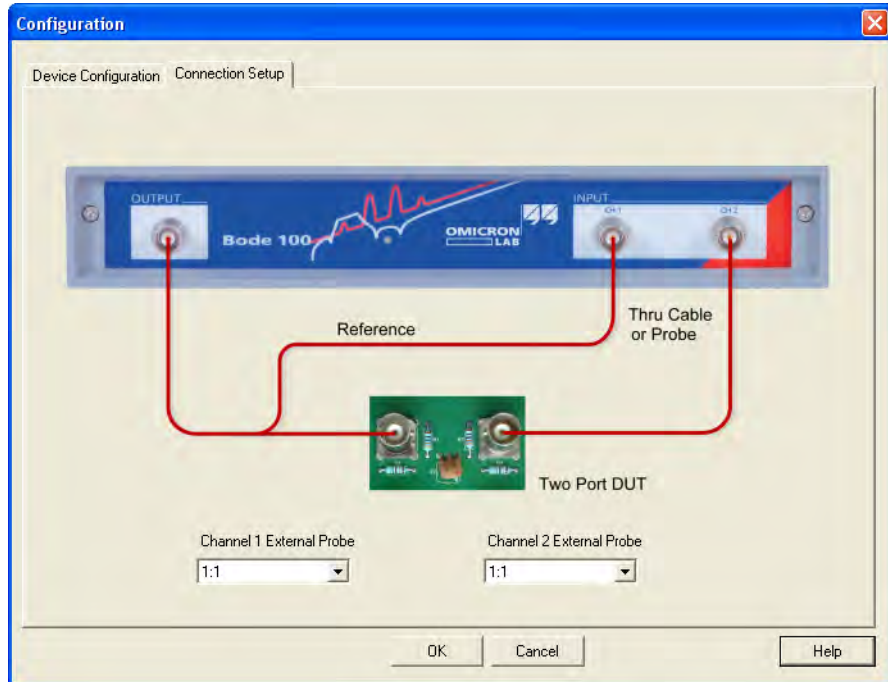

The connection diagram shows how to connect the DUT to the *Bode 100*.

- Connect the cables you want to use for the measurement as shown below.



- Click  to close the **Configuration** window.
- Choose either the **Probe Calibration** or the **User Calibration** and click the respective toolbar button.

8. In the respective calibration window, click the **Start** button next to **Thru** to calibrate the *Bode 100*.

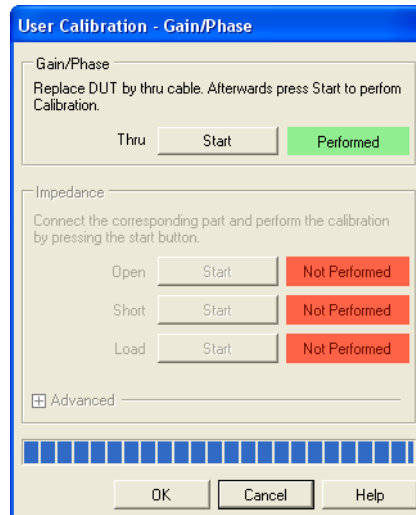

Note: In the **Gain/Phase** mode, no **Impedance** calibration is possible.

The **Gain/Phase** mode is now calibrated for the current specific measurement setup. Refer to 8.1 "Calibration Methods" on page 89 to learn in which cases you have to repeat the calibration if a parameter is changed.

9. Click .

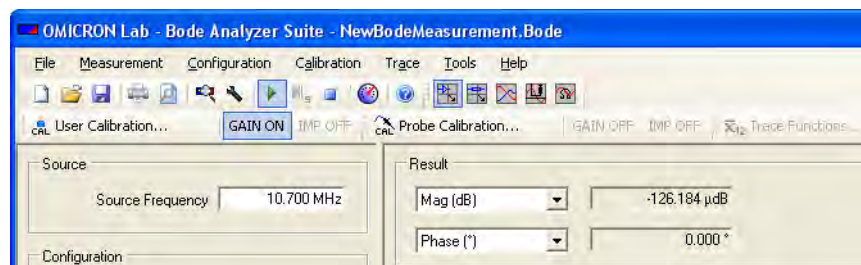

In our case we read $-126 \mu\text{dB}$ (-0.000126 dB) and 0.000° . Because we are close to zero your results may differ from this example. Nevertheless the displayed values should be very small.

10. The calibration is done and you can replace the BNC straight adapter with your DUT as shown below.



8.4 Calibration in the Impedance/Reflection Mode

By calibrating the *Bode 100* you can remove the effects of the connection setup on the accuracy of the measurement results in the **Impedance/Reflection** mode. Without calibration the reference plane of the impedance measurements is at the BNC connector of the *Bode 100* source output. Therefore if a DUT is connected through a cable, the measured impedance is the combination of the cable's impedance and the DUT's impedance. By calibrating the *Bode 100* you can move the reference plane for the impedance measurement to the end of the connection cable and fully remove the influence of the cable.

In the **Impedance** area of the calibration window, you can set the resistance of the load resistor and the short delay time as shown below.

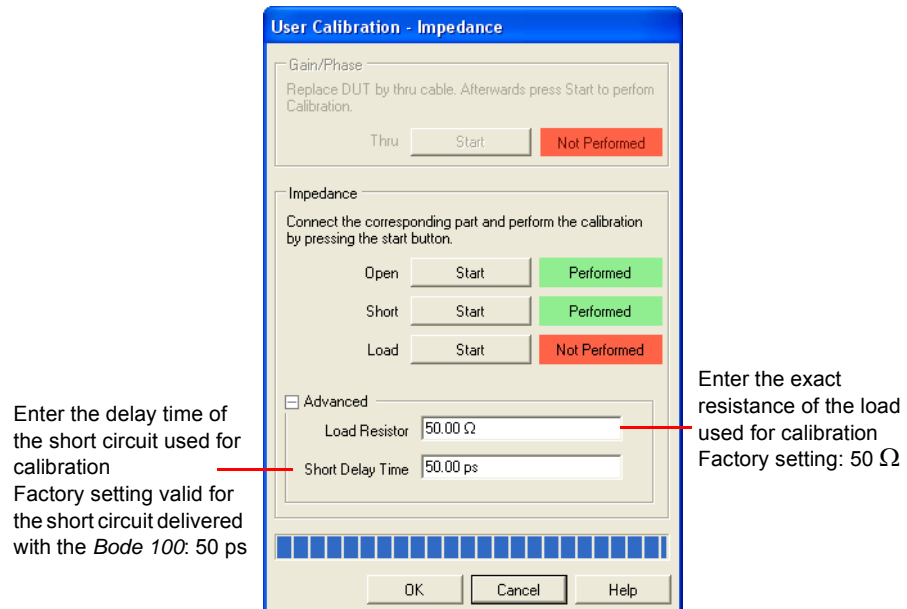

Enter the delay time of the short circuit used for calibration
Factory setting valid for the short circuit delivered with the *Bode 100*: 50 ps

Enter the exact resistance of the load used for calibration
Factory setting: 50 Ω

Hint: If the entered values of the load resistor and/or the short delay time differ from the factory settings a yellow warning symbol appears after the **Advanced** area has been collapsed.

Example: Measure the input impedance of the IF filter at the BNC connector of the PCB (and not the impedance at the input of the cable connecting the filter).

Expected example duration: 20 minutes.

In this example you will learn step by step how to use the calibration of the *Bode 100* in the **Impedance/Reflection** mode.



How to:

- Eliminate the effect of the cable
- Connect the cable in the open, short and load condition
- Connect the DUT

Questions:

- What is the real part of the impedance in Ω ?
- What is the reflection coefficient in dB?

To find out the answers, proceed as follows:

1. Click the **Impedance/Reflection** toolbar button  to switch to the **Impedance/Reflection** mode.
2. Click the **Device Configuration** toolbar button  to open the **Configuration** window.
3. Because we want to test the 10.7 MHz IF filter, set:
 - SOURCE: 10.7 MHz
 - SOURCE: On or Auto
 - Receiver bandwidth: 10 Hz
 - Level: 0 dB

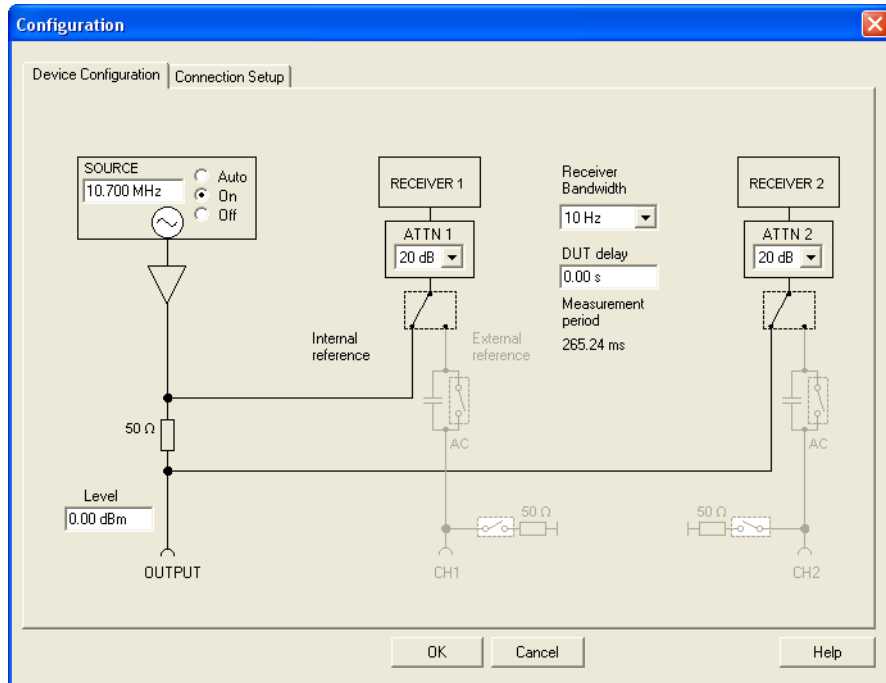

4. Click .
5. Choose either the **Probe Calibration** or the **User Calibration** and click the respective toolbar button.

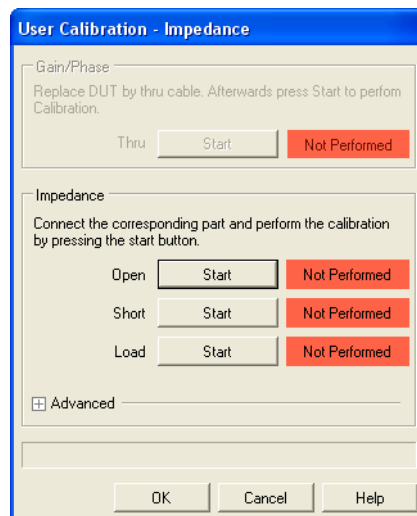

6. Connect the cable you want to use for the measurement to the OUTPUT connector of the *Bode 100*. Plug the BNC straight adapter on the other end of the cable to have the same reference plane for calibration.



7. Click the **Start** button next to **Open** in the **Impedance** area of the calibration window. After the calibration has been finished, the field on the right displays **Performed** on green background.

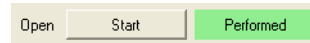

8. Plug the BNC short circuit on the straight adapter connected to the cable.

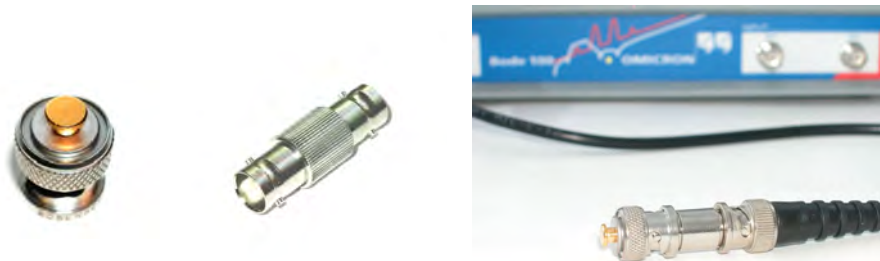

Hint: If you use a short circuit other than the one delivered with your *Bode 100* you can enter the short delay by clicking the + symbol next to **Advanced** and typing the short delay time.

9. Click the **Start** button next to **Short** in the **Impedance** area of the calibration window. After the calibration has been finished, the field on the right displays **Performed** on green background.

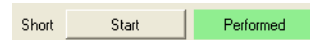

10. Replace the BNC short circuit with the BNC 50 Ω load.



11. For very accurate measurements or if you use a load resistor different from 50 Ω, click the + symbol next to **Advanced**, and then enter the exact resistance of the load resistor.
12. Click the **Start** button next to **Load** in the **Impedance** area of the calibration window. After the calibration has been finished, the field on the right displays **Performed** on green background.

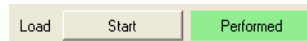

13. After the calibration has been finished, the calibration window looks like shown below.

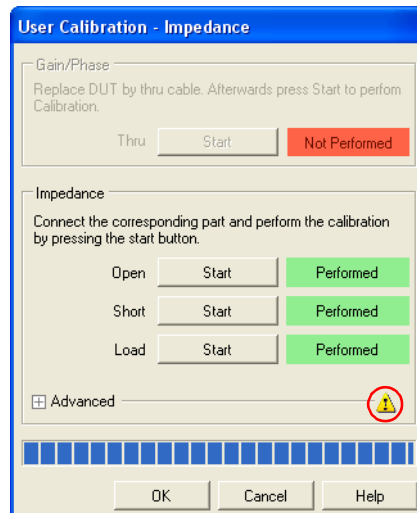

Hint: If the entered values of the load resistor and/or the short delay time differ from the factory settings a yellow warning symbol appears after the **Advanced** area has been collapsed.

14. Click . You have done the **Impedance** calibration.
15. Open the **Configuration** window by clicking the **Device Configuration** toolbar button  to see how to connect your DUT to the *Bode 100*.

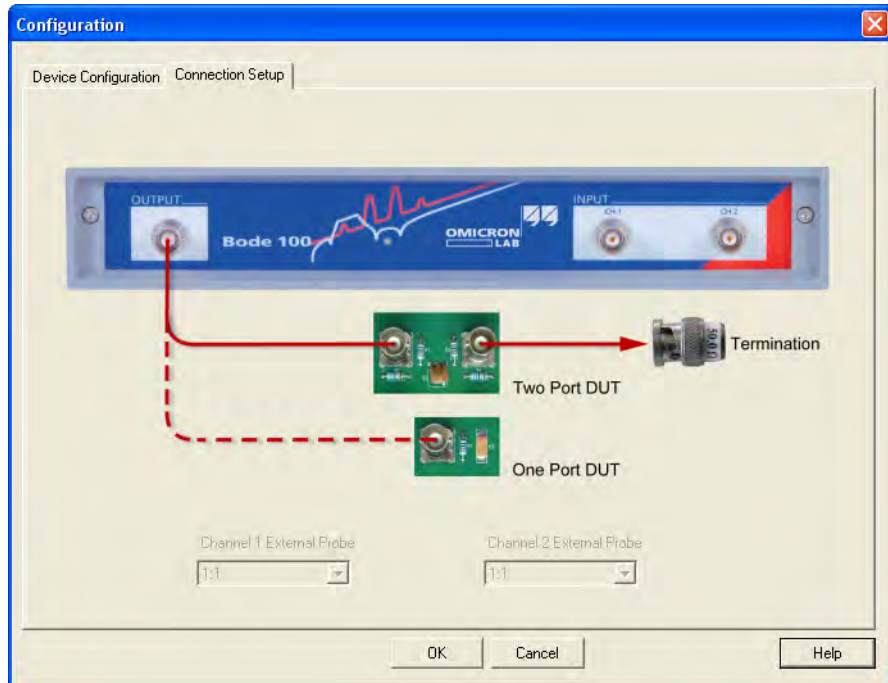

16. Connect the test object.



Note: The IF filter is a two-port device. To ensure that the impedance of the filter is measured correctly, its output must be terminated. For measuring a one-port device like a capacitor or an inductor, no termination resistor is needed.

17. Read the results.

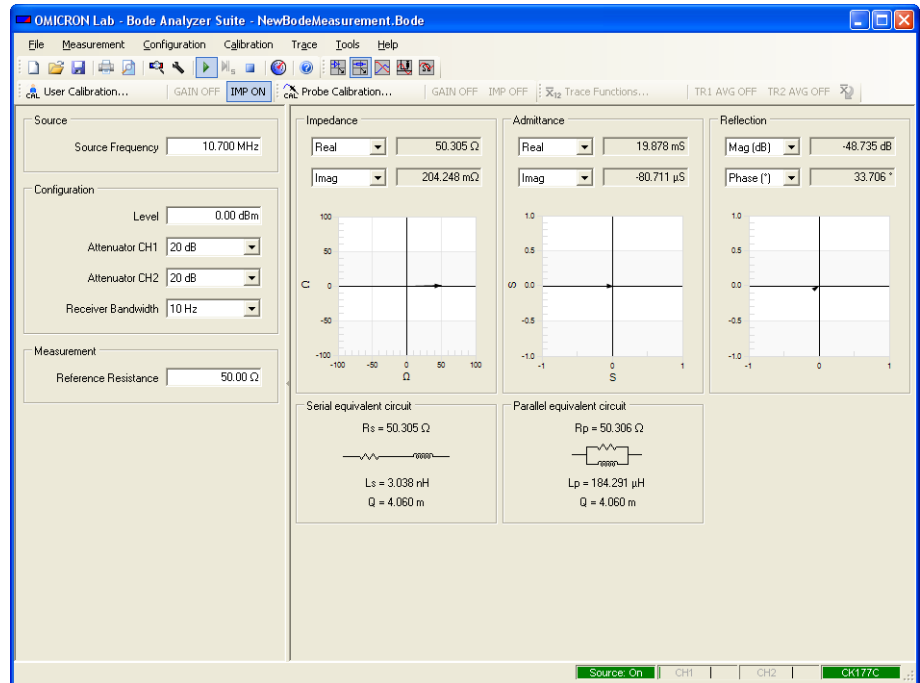

Answers:

- The real part of the impedance is 50.3 Ω .
- The magnitude of the reflection coefficient is -48.7 dB.

Your results may differ because every IF filter and measurement setup is slightly different.



I had my first cable problem when I was born but luckily the midwife solved that problem.

Congratulation! You learned the calibration of the *Bode 100* in the **Impedance/Reflection** mode.

How to:

- Eliminate the effect of the cable
- Connect the cable in the open, short and load condition
- Connect the DUT

8.5 Calibration in the Frequency Sweep Mode

In the **Frequency Sweep** mode, you can perform **Gain/Phase** and **Impedance/Reflection** measurements. Therefore both the **Gain/Phase** and the **Impedance** calibration are available. The actually performed measurements depend on the measurement type assigned to **Trace 1** and **Trace 2**.

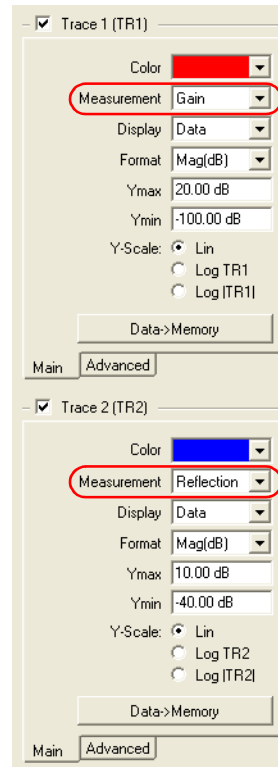

To perform the **Gain/Phase** calibration in the **Frequency Sweep** mode, proceed as described in 3.3 "Example: Gain/Phase Measurement" on page 26 or if you use an external reference proceed as described in 8.3 "Calibration in the Gain/Phase Mode (External Reference Connection)" on page 92. For the **Impedance** calibration, see 5.2 "Impedance Calibration" on page 62.

Hints:

The calibration time for the **User Calibration** depends on the number of measurement points and the selected receiver bandwidth.

The calibration time required for the **Probe Calibration** depends only on the selected receiver bandwidth.

When working with the *Bode 100* at frequencies below 10 Hz, the calibration can take quite long.



8.6 Calibration in the Frequency Sweep (External Coupler) Mode

By calibrating the *Bode 100* in the **Frequency Sweep (External Coupler)** mode you remove the effects of the connection setup including the external coupler and, if used, the amplifier on the accuracy of the measurement results. Due to the strongly varying parameters of directional couplers a calibration is mandatory before performing a measurement.

In the **Frequency Sweep (External Coupler)** mode, you can perform only **Impedance/Reflection** measurements. Therefore only the **Impedance** calibration is available in this mode.

Hint: Some directional couplers show nonlinear behavior at the edges of their passband. If your measurement frequency range is close to such nonlinearities, we recommend to use the **User Calibration** to remove the nonlinear effects.

To calibrate the *Bode 100* in the **Frequency Sweep (External Coupler)** mode:

1. Click the **Frequency Sweep (External Coupler)** toolbar button  to switch to the **Frequency Sweep (External Coupler)** mode.
2. Click the **User Calibration** toolbar button  to open the calibration window.

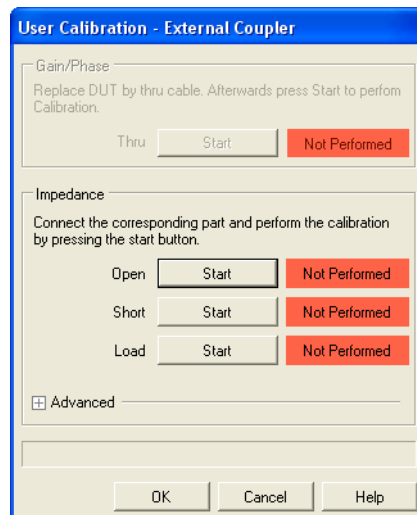

3. Plug the BNC straight adapter on the end of the cable.



4. Click the **Start** button next to **Open** in the **Impedance** area of the calibration window. After the calibration has been finished, the field on the right displays **Performed** on green background.

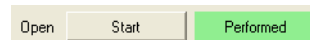

5. Plug the BNC short circuit on the straight adapter connected to the cable.



6. Click the + symbol next to **Advanced**, and then enter the short delay time (only if you use a short circuit other than the one delivered with your *Bode 100*).
7. Click the **Start** button next to **Short** in the **Impedance** area of the calibration window. After the calibration has been finished, the field on the right displays **Performed** on green background.



8. Replace the BNC short circuit with the BNC 50 Ω load.



9. For very accurate measurements or if you use a load resistor different from 50 Ω , enter the exact resistance of the load resistor in the respective box in the **Advanced** area of the calibration window.
10. Click the **Start** button next to **Load** in the **Impedance** area of the calibration window. After the calibration has been finished, the field on the right displays **Performed** on green background.

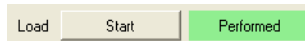

11. After the calibration has been finished, the calibration window looks like shown below.

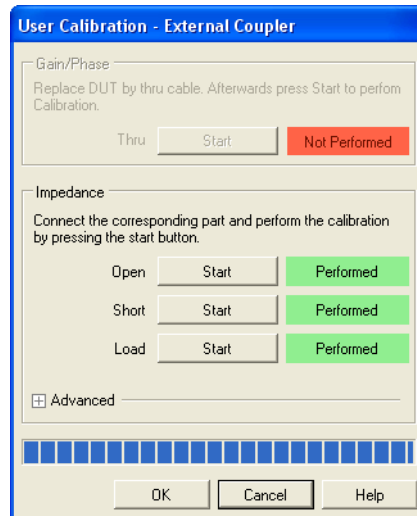

Hint: A yellow warning symbol displayed close to **Advanced** indicates that the short delay and/or the load resistance entered in the **Advanced** area differ from the factory settings.

12. Click . You have done the **Impedance** calibration in the **Frequency Sweep (External Coupler)** mode.

8.7 Calibration in the Frequency Sweep (Impedance Adapter) Mode

By calibrating the *Bode 100* in the **Frequency Sweep (Impedance Adapter)** mode you remove the effects of the connection setup on the accuracy of the measurement results. To measure the impedance of a DUT connected to the impedance adapter the calibration point needs to be at the impedance adapters connectors. Therefore calibration is mandatory before performing a measurement.

In the **Frequency Sweep (Impedance Adapter)** mode, you can perform only **Impedance/Reflection** measurements. Therefore only the **Impedance** calibration is available in this mode.

To calibrate the *Bode 100* in the **Frequency Sweep (Impedance Adapter)** mode:

1. Click the **Frequency Sweep (Impedance Adapter)** toolbar button  to switch to the **Frequency Sweep (Impedance Adapter)** mode.
2. Click the **User Calibration** toolbar button  or the **Probe Calibration** toolbar button  to open the corresponding calibration window.

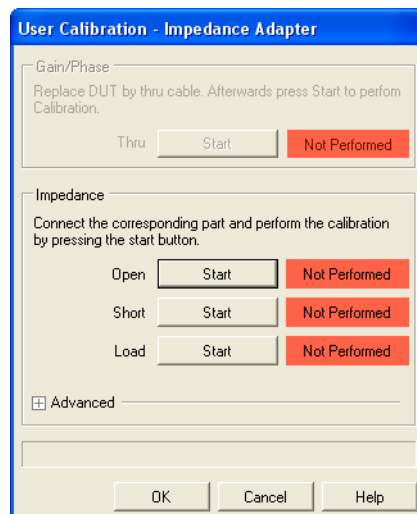

3. Connect the impedance adapter used for the measurement to the *Bode 100*.

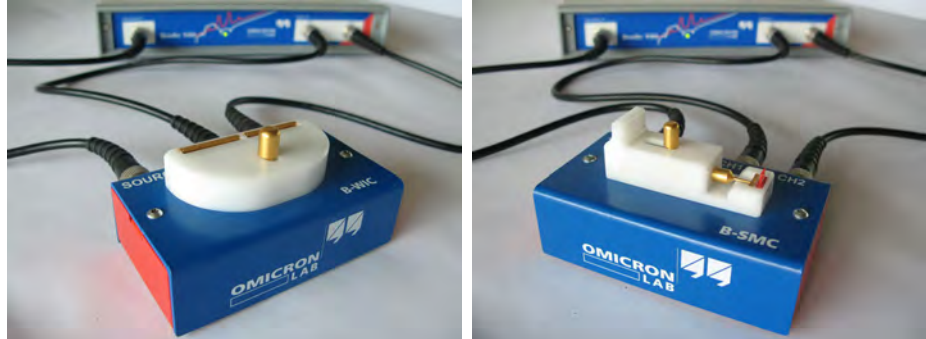

4. If you use the B-SMC impedance adapter, separate its DUT connectors by using the small jumper delivered with the adapter as shown in the following figures.

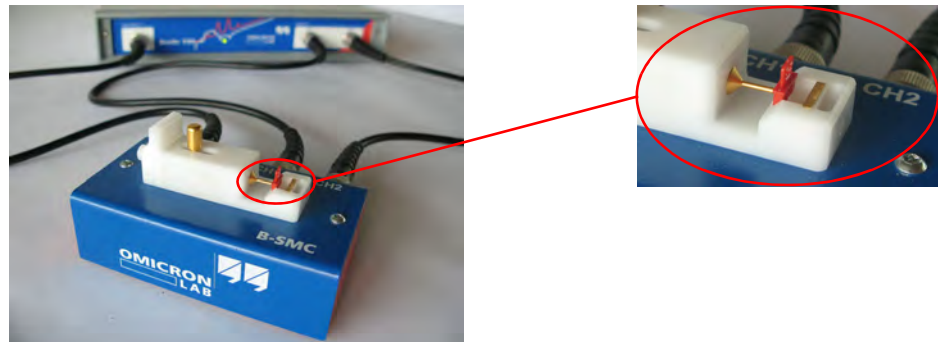

- Click the **Start** button next to **Open** in the **Impedance** area of the calibration window. After the calibration has been finished, the field on the right displays **Performed** on green background.

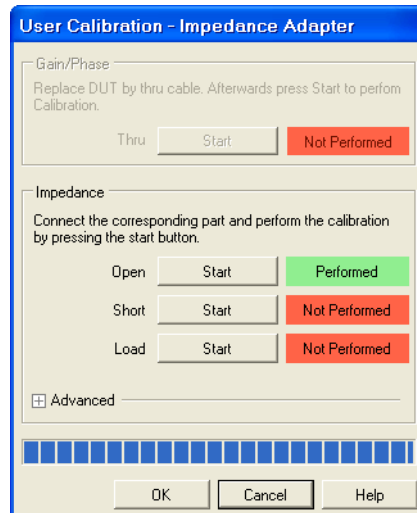

- Short-circuit the DUT connectors of the impedance adapter.

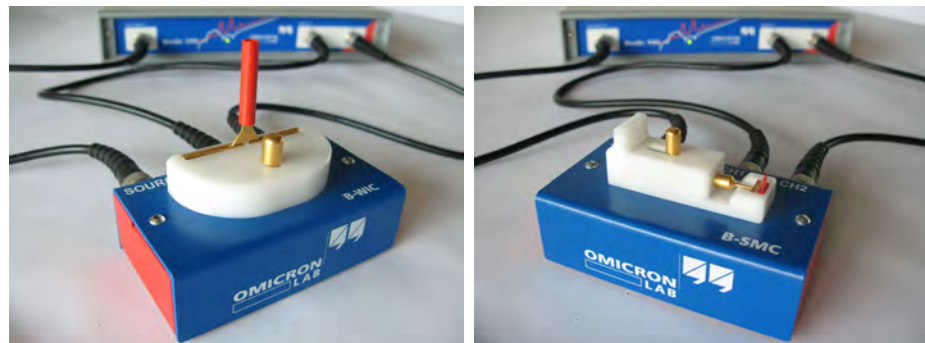

Hint: For the B-WIC impedance adapter use the delivered short circuit.

- Click the **Start** button next to **Short** in the **Impedance** area of the calibration window. After the calibration has been finished, the field on the right displays **Performed** on green background.

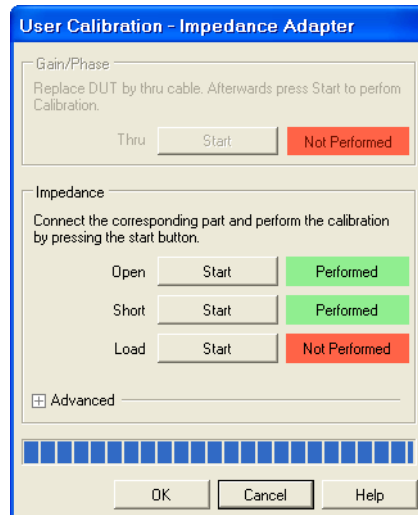

8. Connect the 100 Ω load resistor delivered with the impedance adapter to the DUT connectors as shown in the following figures.

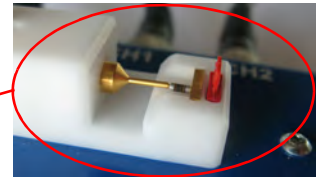

9. For very accurate measurements or if you use a load resistor different from $100\ \Omega$, enter the exact resistance of the load resistor in the respective box in the **Advanced** area of the calibration window.

The screenshot shows the 'User Calibration - Impedance Adapter' dialog box. It has a blue title bar and a light gray background. The 'Gain/Phase' section is collapsed. The 'Impedance' section is expanded and contains three rows: 'Open', 'Short', and 'Load'. Each row has a 'Start' button and a status field. 'Open' and 'Short' have green 'Performed' status, while 'Load' has a red 'Not Performed' status. The 'Advanced' section is expanded, showing a 'Load Resistor' text box with '100.00 Ω' and a 'Short Delay Time' text box with '0.00 s'. The 'Load Resistor' text box is highlighted with a red oval. At the bottom are 'OK', 'Cancel', and 'Help' buttons.

10. Click the **Start** button next to **Load** in the **Impedance** area of the calibration window. After the calibration has been finished, the field on the right displays **Performed** on green background.

This screenshot is identical to the previous one, but the 'Load' status field now shows 'Performed' on a green background, indicating that the calibration for the load resistor has been successfully completed.

Hint: A yellow warning symbol displayed close to **Advanced** indicates that the short delay and/or the load resistance entered in the **Advanced** area differ from the factory settings.

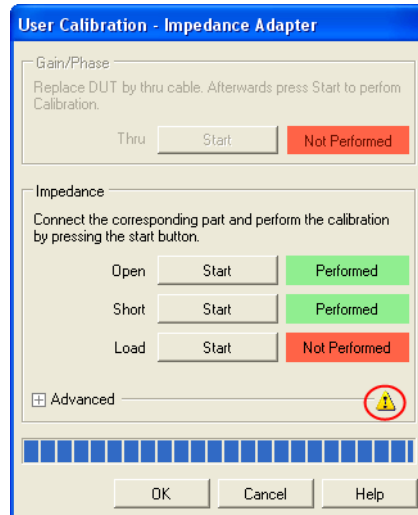

11. Click . You have done the **Impedance** calibration in the **Frequency Sweep (Impedance Adapter)** mode.

9 Common Functions

In this section you can find the *Bode Analyzer Suite* basics. The section provides an overview of the toolbars, menus and commands common to all measurement modes. Further on, this section explains how to change the measurement range, how to select the measurement speed, how to export the data, and how to store and load configuration files.

9.1 Toolbars, Menus and Commands

Figure 9-1:
Toolbar

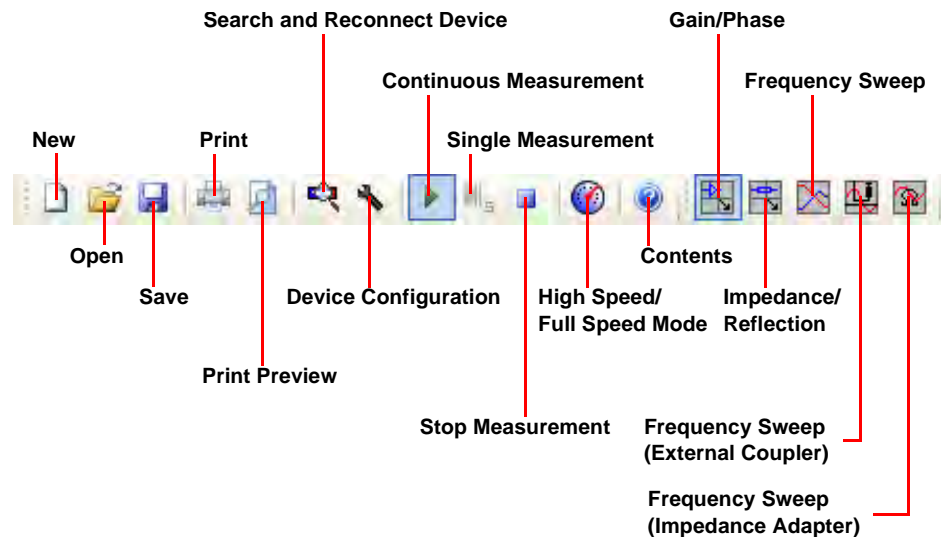

Figure 9-2:
Calibration and trace functions toolbar

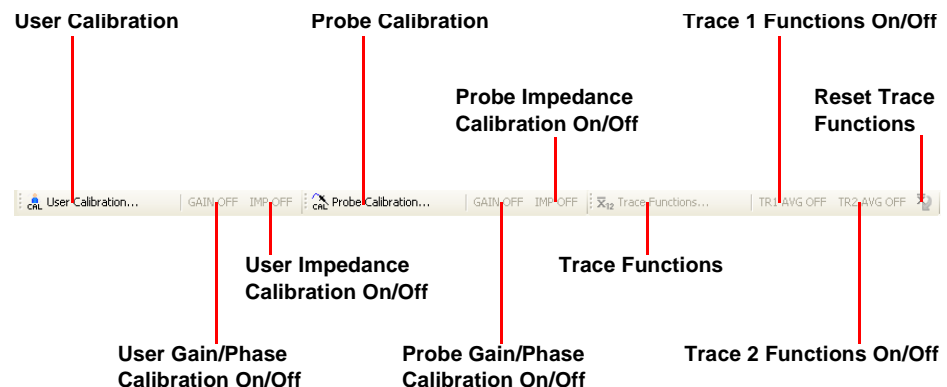

Table 9-1:
File menu















Command	Description
 New	Opens the NewBodeMeasurement.Bode file containing default settings.
 Open	Opens a .Bode file containing saved settings and measurement data.
 Save	Saves the device configuration, measurement settings, calibration and measurement data and the graphical display settings.
Save As	
 Print	Prints a report containing the diagram, measurement results, and device configuration data.
 Print Preview	Previews the print report.
Exit	Enables you to exit the <i>Bode Analyzer Suite</i> .

Table 9-2:
Measurement menu

Command	Description
 Gain/Phase	Selects the Gain/Phase measurement mode.
 Impedance/Reflection	Selects the Impedance/Reflection measurement mode.
 Frequency Sweep	Selects the Frequency Sweep measurement mode.
 Frequency Sweep (External Coupler)	Selects the Frequency Sweep (External Coupler) measurement mode.
 Frequency Sweep (Impedance Adapter)	Selects the Frequency Sweep (Impedance Adapter) measurement mode.
 Continuous Measurement	Starts a continuous measurement.
 Single Measurement	Starts a single frequency sweep measurement. ¹
 Stop Measurement	Stops a measurement. The last result remains displayed.
 High Speed/ Full Speed Mode	Toggles between the High Speed and Full Speed mode (see 9.3 "Selecting the Measurement Speed" on page 120).

1. Only available in the **Frequency Sweep** modes

Table 9-3:
Configuration menu



Command	Description
 Device Configuration	Opens the Configuration window for configuring the <i>Bode 100</i> .
Connection Setup	Shows the connection of the DUT to the <i>Bode 100</i> .
 Search and Reconnect Device	Reconnects the <i>Bode 100</i> with the computer.

Table 9-4:
Calibration menu



Command	Description
 User Calibration	Starts the User Calibration (see 8 "Calibrating the Bode 100" on page 89).
 Probe Calibration	Starts the Probe Calibration (see 8 "Calibrating the Bode 100" on page 89).

Table 9-5:
Trace menu





Command	Description
 Trace Functions	Opens the Trace Functions – Settings dialog box for setting the parameters of trace functions (see 10.4 "Using the Trace Functions" on page 147).
 Reset Trace Functions	Resets the trace functions (see 10.4 "Using the Trace Functions" on page 147).

Table 9-6:
Tools menu

Command	Description
Options	Opens the Options dialog box for setting the options (see 9.2 "Setting the Measurement Range" on page 120, 9.4 "File Operations" on page 121, and 9.4.1 "Loading and Saving the Equipment Configuration" on page 121).

Table 9-7:
Help menu

Command	Description
 Contents	Starts the <i>Bode Analyzer Suite</i> Help.
 Bode 100 Web site	Opens the OMICRON Lab Web site www.omicron-lab.com .
About	Displays the <i>Bode Analyzer Suite</i> version.

9.2 Setting the Measurement Range

With the *Bode 100* you can perform measurements within 10 Hz...40 MHz (default frequency range) and 1 Hz...40 MHz (extended frequency range). To select the measurement range, click **Options** on the **Tools** menu, click the **Measurement** tab, and then select the frequency range for your measurement.

Figure 9-3:
Setting the
measurement range

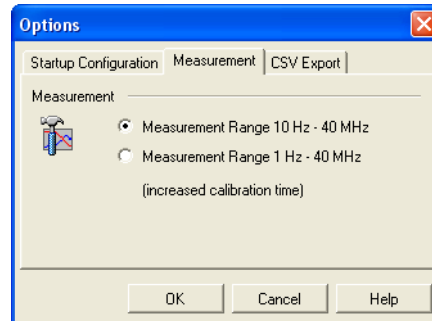



9.3 Selecting the Measurement Speed

You can operate your *Bode 100* in the **High Speed** and **Full Speed** mode. By default, the *Bode Analyzer Suite* starts in the **High Speed** mode. The **High Speed** mode is recommended for measurements where you have to expect distortions from the DUT.

The **Full Speed** mode increases the *Bode 100* measurement speed. In the **Full Speed** mode, the sweep times are reduced considerably especially at low receiver bandwidths and at low measurement frequencies.

Table 9-8:
Selecting the
measurement speed

Measurement Speed	Action
Full Speed mode	Click the High Speed/Full Speed Mode toolbar button  or the High Speed/Full Speed Mode command on the Measurement menu.
High Speed mode	Click the High Speed/Full Speed Mode toolbar button  or the High Speed/Full Speed Mode command on the Measurement menu

9.4 File Operations



The *Bode 100* supports the following file operations.

9.4.1 Loading and Saving the Equipment Configuration

You can store all settings of the *Bode 100* including the device configuration, measurement settings, calibration and measurement data and the graphical display settings by clicking the **Save** toolbar button  (see Table 9-1: "File menu" on page 118).

Hint: This functionality allows you to store multiple equipment configurations for repetitive measurement tasks. With the equipment configurations stored, you can load the respective files for each measurement instead of setting the *Bode 100* manually.

A saved file containing the *Bode 100* settings has the .Bode extension. The file is stored in XML format and can be viewed with standard Web browsers or a simple text editor tool.

After loading a .Bode file the stored measurement data is displayed. To preserve these values, the measurement is held (the **Stop Measurement** toolbar button  is activated). In this state you can change display options and use cursors to read measurement data. To start a measurement with the loaded configuration and settings, click the **Continuous Measurement** toolbar button .

Hint: To ensure that the *Bode 100* starts with the same configuration as in your last session, click **Options** on the **Tools** menu, click the **Startup Configuration** tab, and then select **Settings from last session**.

Figure 9-4:
Setting the startup
configuration

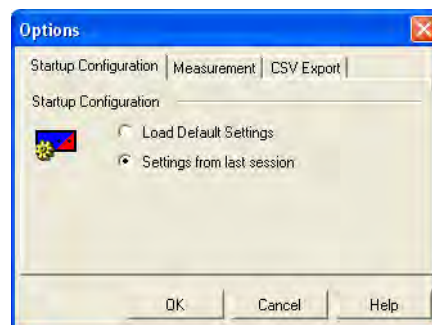

Hint: If you have selected **Settings from last session** the calibration settings of you last session are NOT loaded. This is done on purpose since your measurement setup might have changed since you last used the *Bode 100*. If

you want to load measurement settings including the calibration data, use the *Bode 100* file functions (see 9.4.1 "Loading and Saving the Equipment Configuration" on page 121). However, we recommend to recalibrate the *Bode 100* each time you start a new work session.

9.4.2 Exporting Measurement Data



In all frequency sweep modes (), you can export the measurement data by clicking the  button. In addition to the trace (measurement) data, all equipment settings are exported into a comma separated .csv file. This file format can be easily processed by standard spreadsheet analysis tools such as Excel[®]. The .csv file always contains the real and the imaginary part of the measured parameter (e.g. gain). Additionally, the measurement data in the selected output format is included.

Figure 9-5:
Displayed CSV file data



---Measurement Setup---				
2	Device Type: Bode100	Serial Number: CK177C	Date: 4/27/2010	Time: 11:29 AM
3	Start Frequency: 10.000 MHz	Stop Frequency: 11.500 MHz	Number of Points: 401	Sweep Mode: Linear Reference Resistance: 50.00 Ohm
4	Source Level: 8.50 dBm	Receiver Bandwidth: 1 kHz	Reference Signal: SourceVoltage	Attenuator CH1: 20 dB Attenuator CH2: 20 dB
6	Frequency (Hz)	TR1: Gain (Real)	TR1: Gain (Imag)	TR1: Gain (dB)
7	10000000	9.33E-06	-1.15E-05	-96.60731336
8	10003750	2.74E-05	-1.96E-06	-91.21655911
9	10007500	1.84E-05	-6.89E-06	-94.13590539
10	10011250	-3.49E-06	-1.35E-05	-97.11576564
11	10015000	2.96E-06	1.46E-05	-96.56593414
12	10018750	-9.08E-06	-1.27E-06	-100.7497379
13	10022500	2.54E-05	1.58E-05	-90.48951491
14	10026250	3.37E-05	-1.15E-05	-88.97996988
15	10030000	5.43E-05	-4.57E-07	-85.31074865
16	10033750	2.67E-05	-1.45E-05	-90.34793514
17	10037500	4.04E-05	5.94E-06	-87.77771872
18	10041250	7.38E-06	1.71E-05	-94.58396448
19	10045000	1.50E-05	1.48E-05	-93.51799247
20	10048750	3.81E-05	9.19E-06	-88.13388058
21	10052500	3.45E-05	-3.42E-05	-86.27164694
22	10056250	9.09E-05	1.53E-05	-80.71211482
23	10060000	5.84E-05	-1.62E-05	-84.35237089

To adapt the .csv file to your requirements, you can choose between different decimal and value separators. To select the separators you want to use, click **Options** on the **Tools** menu, click the **CSV Export** tab, and then select the decimal and value separators.

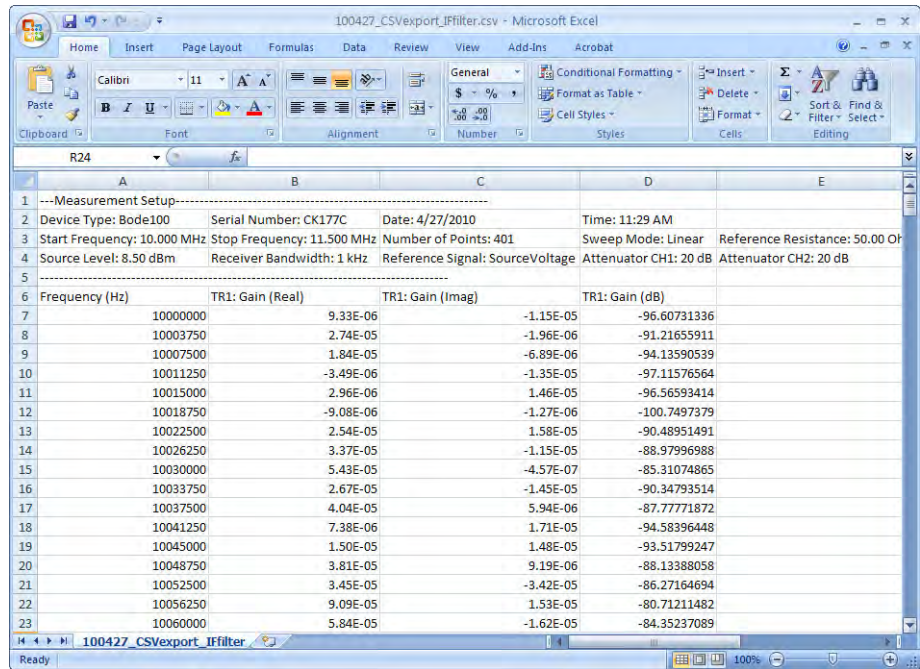
Figure 9-6:
Selecting the
separators

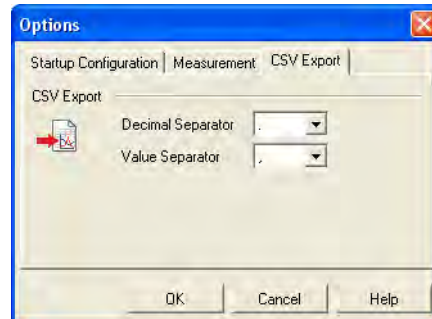

This page intentionally left blank

10 Advanced Functions

The *Bode 100* provides additional features extending the *Bode Analyzer Suite* functionality described in sections 3 to 9 of this User Manual. This section describes these advanced functions which will make your daily measurement tasks with the *Bode 100* even easier.

10.1 Advanced Display Options

In all measurement modes, the *Bode Analyzer Suite* provides several possibilities to visualize the measurement results according to your needs. You can control these advanced display options through the shortcut menus and/or buttons in the main window.

10.1.1 Gain/Phase and Impedance/Reflection Mode

The shortcut menu in the **Gain/Phase** and **Impedance/Reflection** mode is shown below. To open the shortcut menu, right-click a diagram in the graphical display.

Figure 10-1:
Gain/Phase and
Impedance/Reflection
mode shortcut menu,
Grid Cartesian
selected

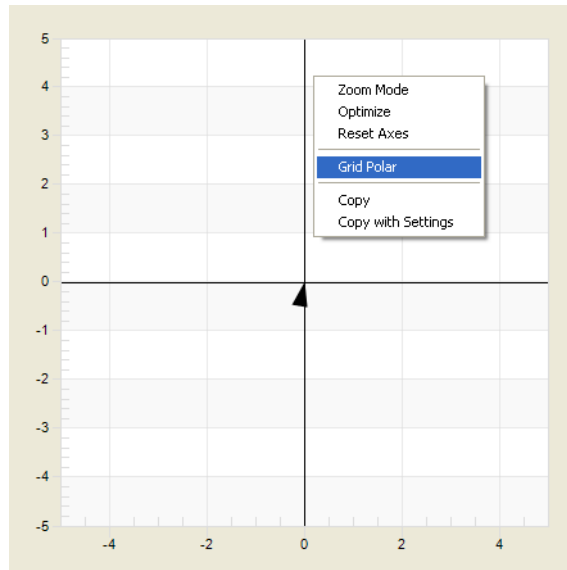
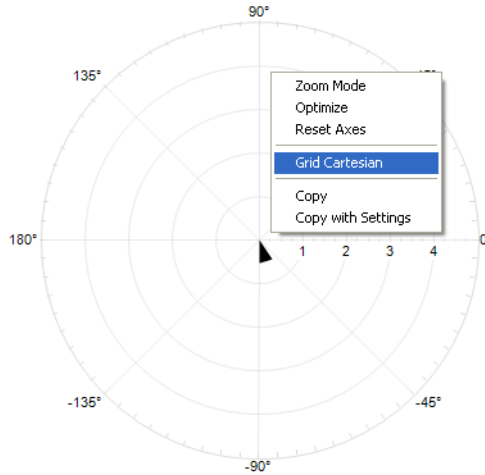

Figure 10-2:
Gain/Phase and
Impedance/Reflection
mode shortcut menu,
Grid Polar selected



Optimize

The **Optimize** command allows you to optimize the diagram by scaling both axes so that you can see the complete measurement result in the highest possible resolution.

Figure 10-3:
Diagram with default
settings

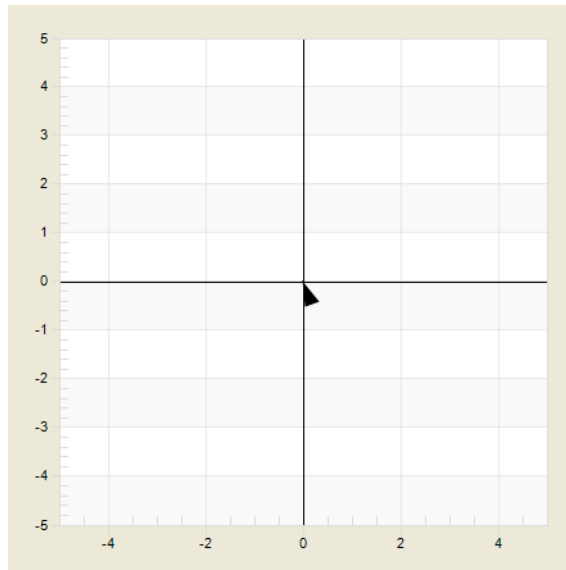
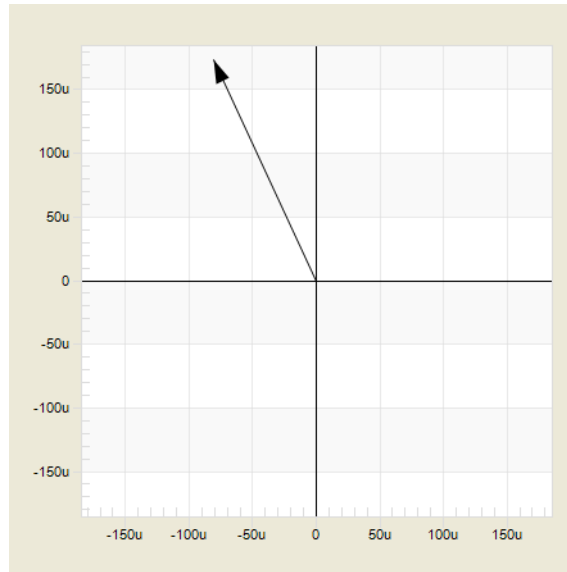

Figure 10-4:
Diagram after applying
Optimize



Reset Axes

The **Reset Axes** command resets both axes of the diagram to the default values.

Zoom Mode

After clicking **Zoom Mode**, the pointer changes to a magnifying glass when you move it over the diagram. Press and hold the left mouse button to select the zoom area. After releasing the left mouse button, the diagram is rescaled to display the zoomed area.

Figure 10-5:
Selecting zoom area

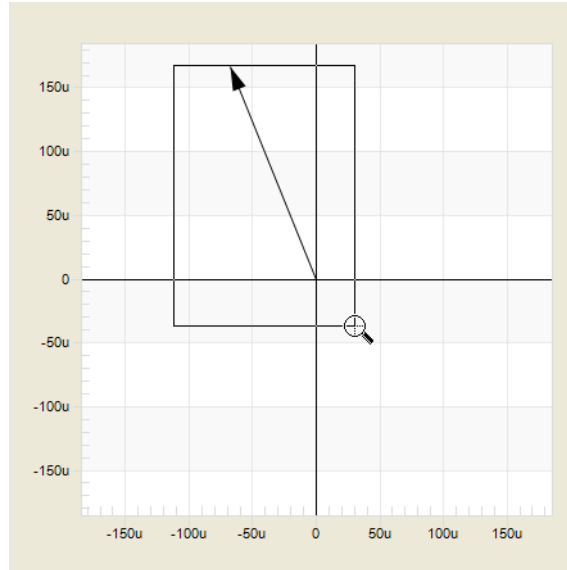

To switch off the zoom mode, right-click in the diagram, and then click **Zoom Mode** to cancel the selection.

To zoom out, right-click in the diagram, and then click **Reset Axes**. To optimize the graphical display, right-click in the diagram, and then click **Optimize**.

Copy

By clicking **Copy** you copy the complete diagram to the clipboard. Thereafter you can insert the diagram into all Windows[®] software applications which support the insertion of graphical clipboard content.

Copy with Settings

By clicking **Copy with Settings** you copy the complete diagram as well as all relevant equipment settings to the clipboard. From there you can insert the data into all Windows[®] software applications which support the insertion of graphical clipboard content. Depending on the chosen Windows[®] application, the clipboard content is inserted as a graphic (e.g. Microsoft Paint), an editable text (e.g. Microsoft Notepad) or a graphic plus the settings in editable text format (Microsoft Word).

10.1.2 Frequency Sweep Modes



The shortcut menu in all frequency sweep modes (,  and ) is shown in the following figure. To open the shortcut menu, right-click the diagram in the graphical display

Figure 10-6:
**Frequency Sweep,
Frequency Sweep
(External Coupler),
and Frequency Sweep
(Impedance Adapter)
mode shortcut menu**



For the **Reset**, **Optimize**, **Copy** and **Copy with Settings** commands, see 10.1.1 "Gain/Phase and Impedance/Reflection Mode" on page 125.

Zoom Mode

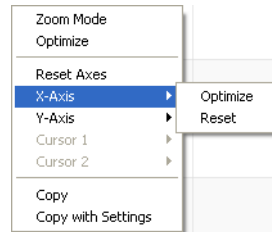
By using the **Zoom Mode** command, you can select a zoom area for an in-depth display of a part of the diagram. The zoom function is a nice way to inspect particular parts of the measurement curve without having to change the measurement parameters.

Figure 10-7:
Selecting the zoom area

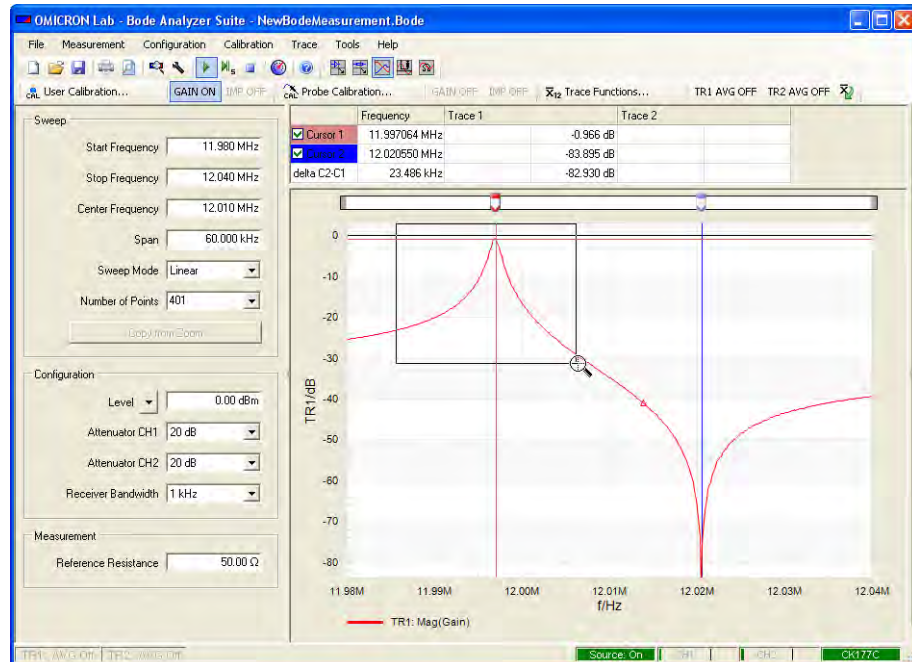
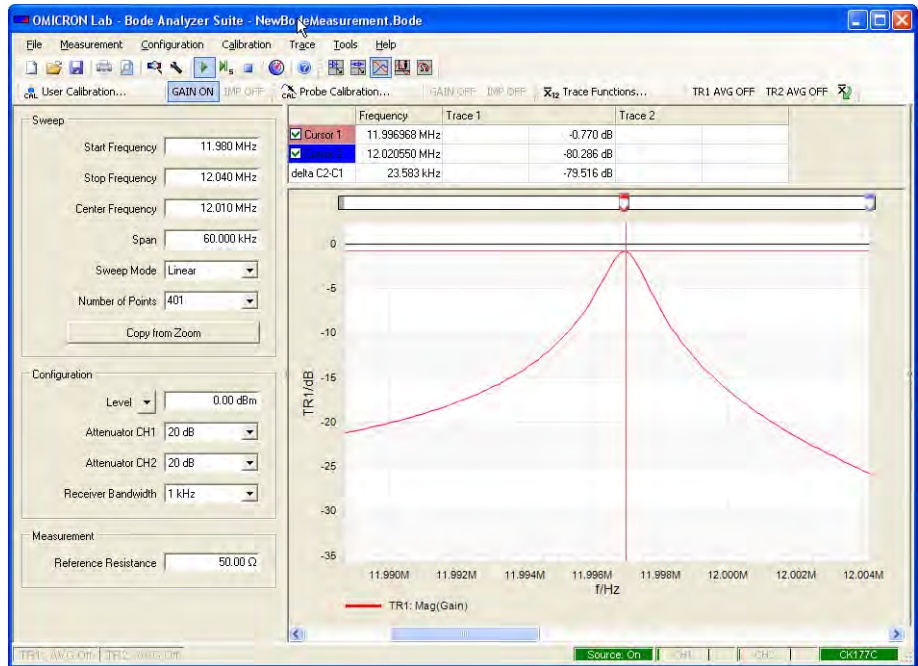

Figure 10-8:
Displaying the zoom
area



In the **Zoom Mode**, the measurement is still performed in the whole frequency sweep range (span); the zoom area applies only to the graphical display. (Compare the sweep settings in Figure 10-7: "Selecting the zoom area" and Figure 10-8: "Displaying the zoom area" above – they are identical.)

To optimize the graphical display in both axes, right-click in the diagram, and then click **Optimize**. Alternatively, you can reset the axes separately by using the **X-Axis** and **Y-Axis** commands.

X-Axis, Y-Axis

To optimize or reset an axis, right-click in the diagram, point to **X-Axis** or **Y-Axis**, and then click the respective command to optimize or to zoom out the selected axis.

**Cursor 1,
Cursor 2**

By using the **Cursor 1** and **Cursor 2** commands, you can set the respective cursor to the minimum and the maximum of a curve as follows:

1. Right-click a curve in the diagram.
2. Point to **Cursor 1** or **Cursor 2**, and then click **Jump to Max** or **Jump to Min** to set the respective cursor to the maximum or the minimum of the curve.

Figure 10-9:
Setting the cursor 1 to
the maximum

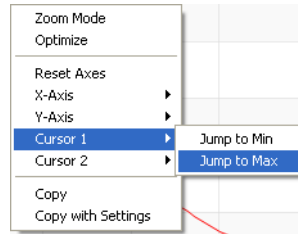

Hint: If both traces are close together and are displayed in one diagram, it might be difficult to select the curve you want to process. In this case, you can click **Always Two Diagrams**, select the trace in the respective diagram, and then set a cursor as described above. Then you can switch back to one-diagram display by clicking **Auto**.

Hint: To set the cursor to a specific frequency, you can enter this frequency directly in the frequency box next to the respective cursor.

Figure 10-10:
Setting the cursor 1 to a
frequency

	Frequency	Trace 1	Trace 2
<input checked="" type="checkbox"/> Cursor 1	10.700 MHz	-30.838 dB	-33.403 dB
<input checked="" type="checkbox"/> Cursor 2	11.300 MHz	-90.898 dB	-25.518 dB
delta C2-C1	600.000 kHz	-60.060 dB	7.885 dB

Copy from Zoom

By clicking the **Copy from Zoom** button you can copy the start and stop frequencies of the zoom area to the sweep settings, keeping the number of measurement points constant. This function is especially useful to measure a detail of a curve with a higher resolution.

Note: The **Copy from Zoom** command is available once the **Zoom Mode** has been activated.

The following figure shows a zoom area of an measurement. Due to the low number of measurement points within the area, the displayed curve is not smooth.

Figure 10-11:
Measured curve with
initial sweep settings

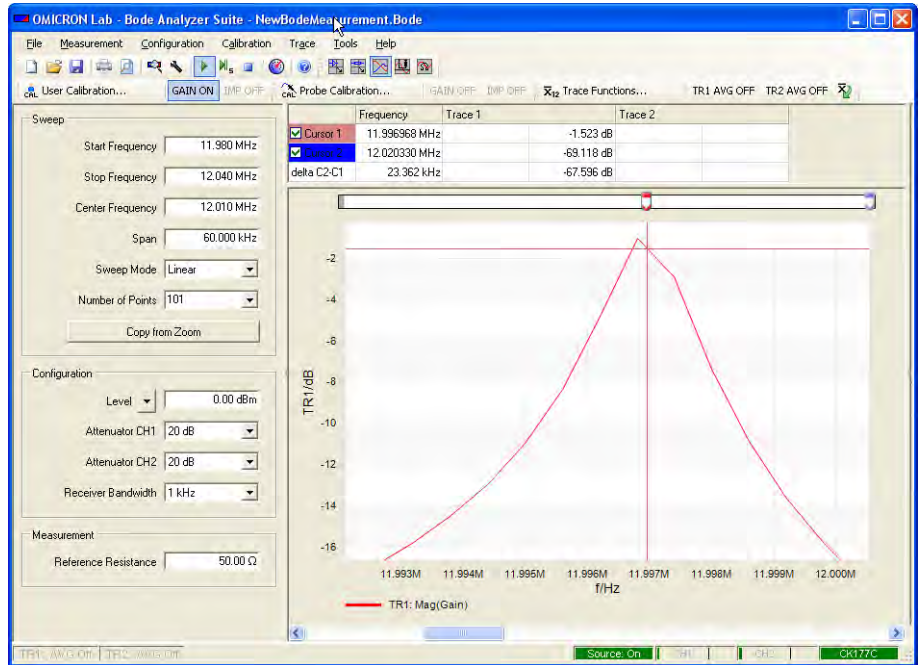

By applying the **Copy from Zoom** function the frequency span is narrower, resulting in a higher resolution of the measured curve.

Figure 10-12:
Measured curve with sweep settings copied from the zoom area

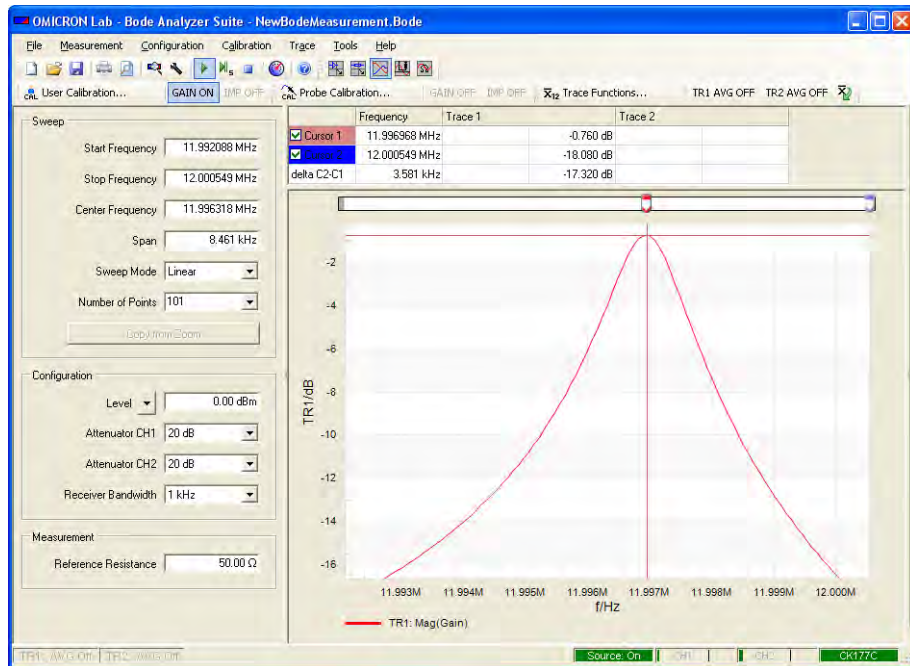

After using the **Copy from Zoom** function, the original sweep settings are lost. If used, the **User Calibration** is switched off, too.

Hint: Compare the frequency sweep settings before (see Figure 10-11: "Measured curve with initial sweep settings" on page 132) and after applying the **Copy from Zoom** function (see Figure 10-12: "Measured curve with sweep settings copied from the zoom area" above).

Special Zoom Function

In the **Zoom Mode**, when moving the pointer over an axis the pointer becomes a double-headed arrow. Then click the left mouse button to zoom in and the right mouse button to zoom out respectively.

Figure 10-13:
Special zoom function applied on Y-axis

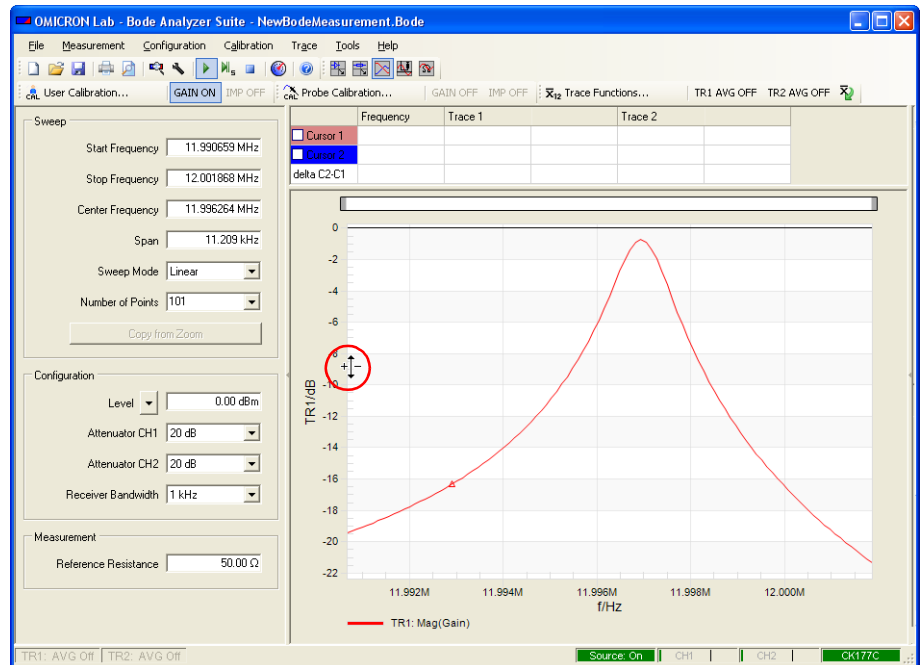

Hint: This function is also available in the **Gain/Phase** mode and in the **Impedance/Reflection** mode.

Data and Memory

With the *Bode 100* you can copy the current measurement data into the trace memory and display it.

To store and display the measurement data:

1. Click the button to store the current measurement data into the trace memory.
2. In the **Display** list, select one of the following:
 - **Data** to display the current measurement data
 - **Memory** to display the stored measurement data
 - **Data/Memory** to display the difference between the current and the stored measurement data
 - **Data & Memory** to display the current and stored measurement data as two curves in the same diagram

Hint: The **Data/Memory** option is particularly useful to compare two electrical components of the same type because even smallest differences in the frequency behavior can be detected easily.

Figure 10-14:
Selecting **Display**
function

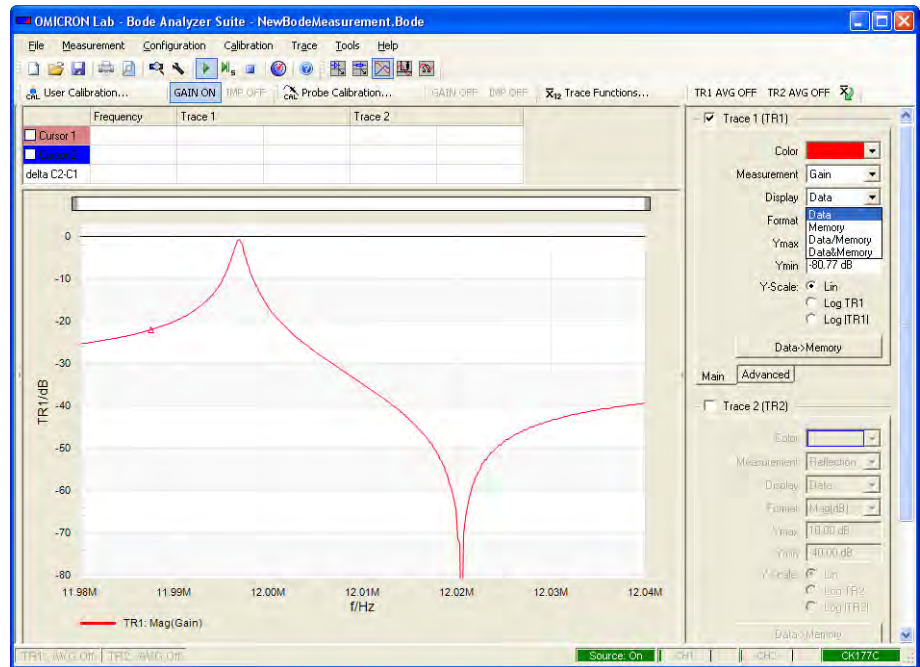

Example: Using the data and memory functions

Example duration: 15 minutes

In this example you will learn step by step how to use the data and memory display function in the **Frequency Sweep** mode.

How to:

- Copy the current measurement data to the trace memory
- Compare the frequency responses
- Detect even smallest differences between the current and stored measurement data by using the **Data/Memory** display function

Question: How does touching the housing of the quartz filter on the sample PCB influence the measurement?

To find out the answer, proceed as follows:

1. Follow steps 1 to 14 of the example outlined in 5.1 "Example: Frequency Sweep Measurement" on page 52.
2. Clear the **Trace 2** check box.
Your screen should now look like this:

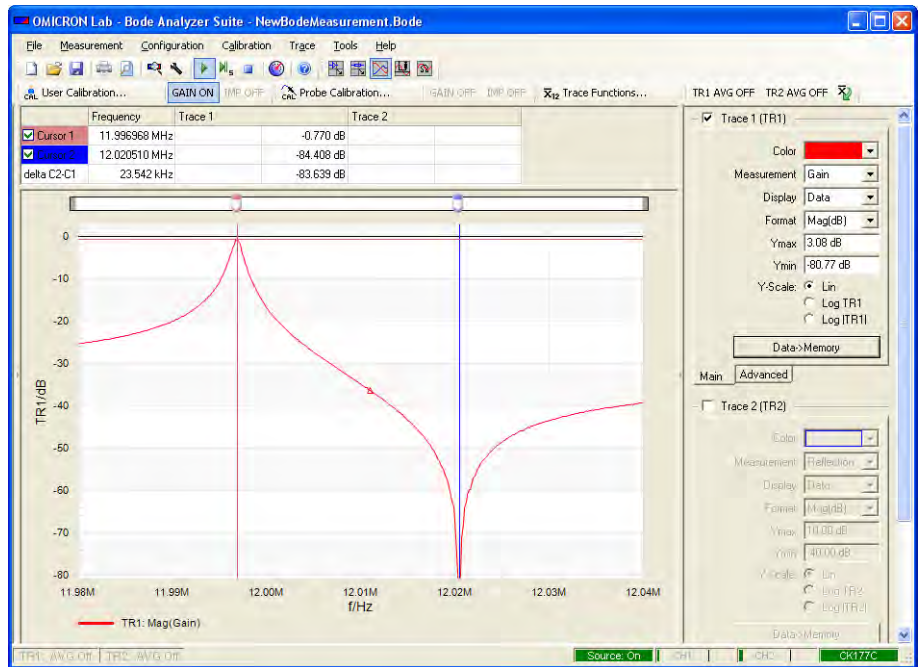

3. Click the Data->Memory button to store the measurement data.

- In the **Display** list, select **Memory**.
The stored data is displayed as a dashed line.

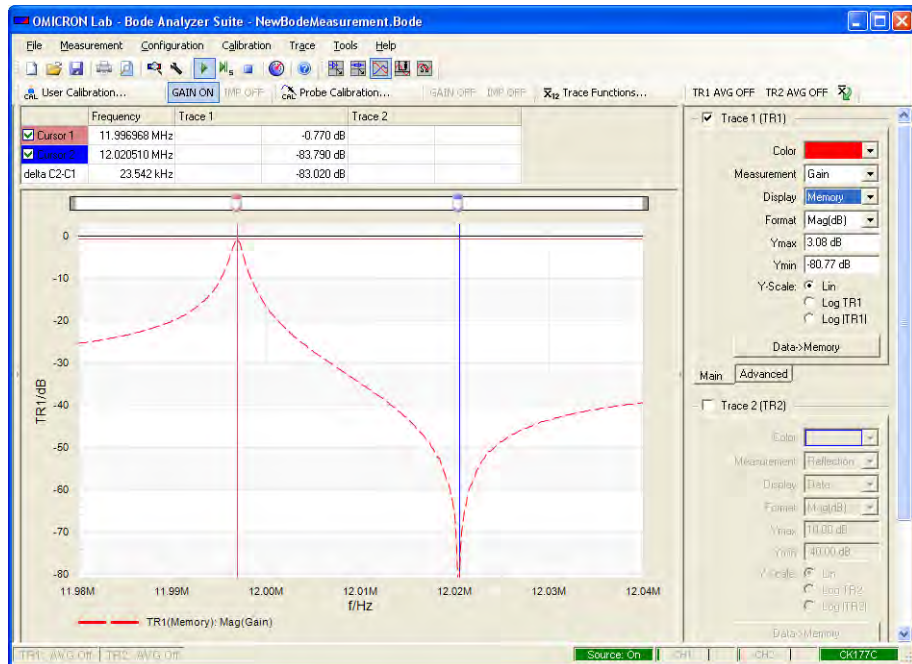

- In the **Display** list, select **Data & Memory**, and then touch the housing of the quartz filter (or even better the pins of the quartz) with your finger.
By doing this you shift the parallel resonance frequency of the filter.
- Mark the new parallel resonance frequency with the cursor 1 by using the **Jump to Min** function. Right-click the curve, point to **Cursor 1**, and then click **Jump to Min**.

Figure 10-15:
Setting the cursor 1 to
the minimum

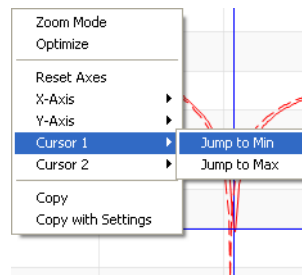

- Now, you can measure the effect of touching the quartz filter by using the **delta C2-C1** function.

Hint: Use the **Zoom Mode** function to get a better view. The figure below shows a zoomed diagram showing the effect of touching the quartz filter's housing.

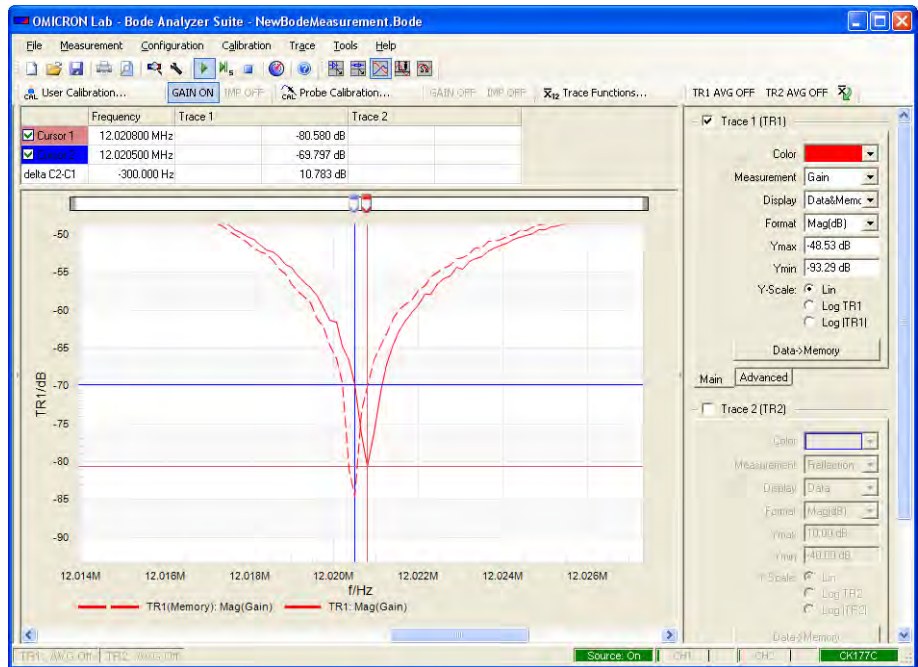

Result: Touching the quartz housing shifts the parallel resonance frequency by 300 Hz. You might measure different values with your quartz filter.

- In the **Display** list, select **Data/Memory**, and then touch the filter.

9. Optimize the Y-axis.

The diagram now displays the difference between the actual measurement data and the stored data.

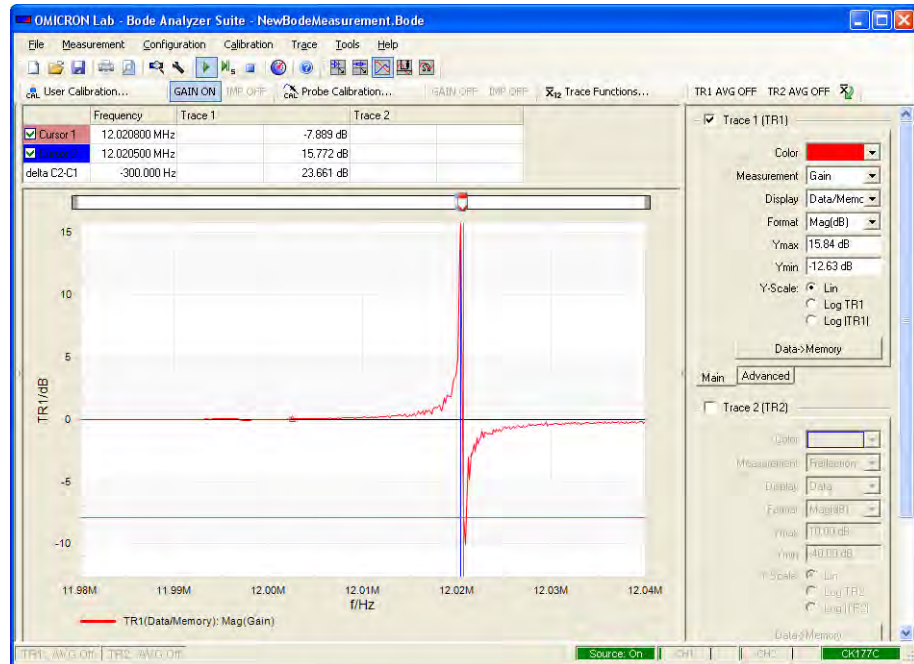

If the curve is above the 0 dB line the current measured data is higher than the stored measurement data. If the curve is below the 0 dB line the currently measured data is lower than the stored measurement data.





Hint: The **Data/Memory** function allows you to detect even smallest differences between different parameters of the same component type (e.g. comparison of two quartz filters of the same type).

Congratulation! You learned how to use the data and memory functions in the **Frequency Sweep** mode.

How to:

- Copy the current measurement data to the trace memory
- Compare the frequency responses
- Detect even smallest differences between the current and stored measurement data by using the **Data/Memory** display function

10.2 Advanced Sweep Options

In all frequency sweep modes (, , and ), you can choose between continuous sweep  and single sweep  measurements. In most applications, it is recommended to use the continuous sweep measurement since all measurement data is periodically updated.

Single Sweep

You can use the single sweep  measurement to capture one-time events or to produce a stable curve before using the **Copy** or **Copy with Settings** function.

DUT Delay, Measurement Period

In the **Configuration** window, you can find the **DUT delay** and **Measurement period** boxes.

Figure 10-16:
DUT delay and
Measurement period
fields

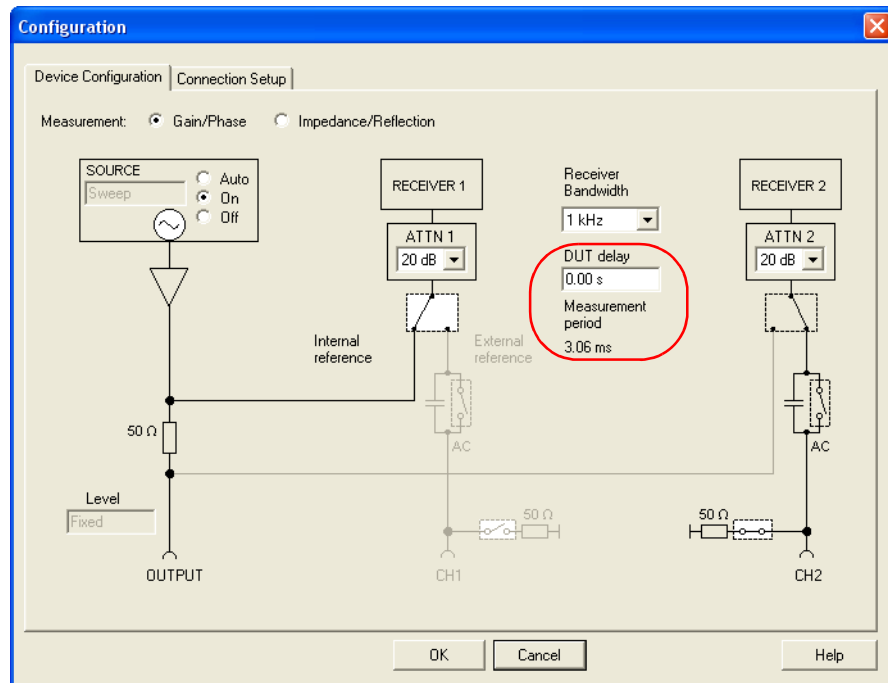

The measurement period indicates the time the *Bode 100* requires to perform measurement at one frequency point. By multiplying this value with the selected number of measurement points you can get an estimate of the expected sweep time.

Example: Expected sweep time for 401 points and a measurement period of 3.06 ms

$$\text{sweep time} = 3.06 \text{ ms} \cdot 401 \text{ frequency points} = 1.2 \text{ s}$$

Some devices under test require a settling time when the input frequency has been changed (e.g. phase-locked loops). The DUT delay allows setting this waiting time.

Let's assume our DUT requires a 10 ms settling time each time the input frequency has changed. To allow for this waiting time, enter 10 ms in the DUT delay box.

Figure 10-17:
Setting the DUT delay

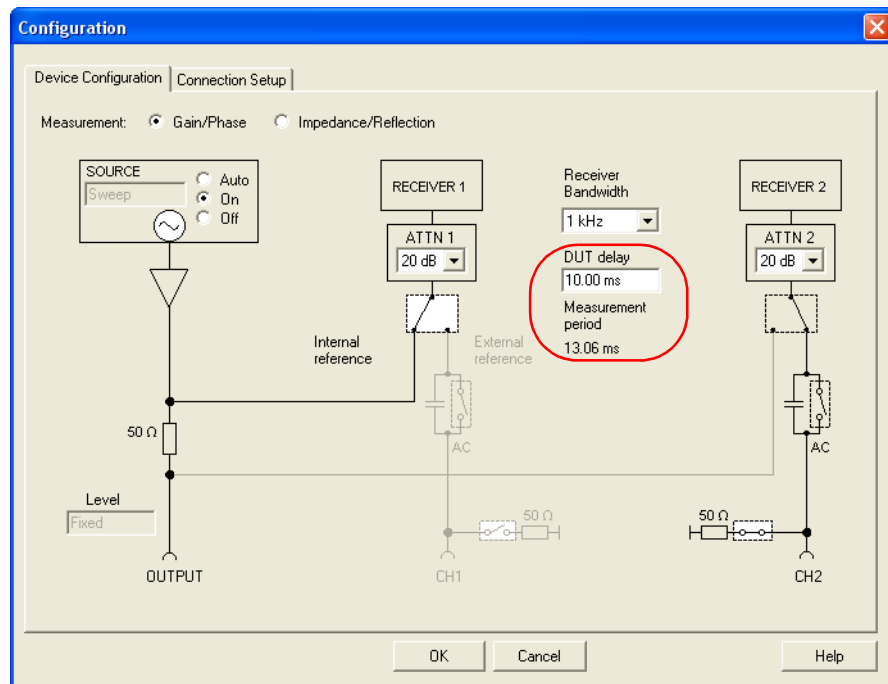

The measurement period is automatically updated. When using the same number of measurement points as before, the sweep time is now much longer.

$$\text{sweep time} = 13.06 \text{ ms} \cdot 401 \text{ frequency points} = 5.23 \text{ s}$$

Hint: Set the DUT's delay to zero after your measurement is completed to ensure the shortest sweep time possible for next measurements.

Number of Measurement Points

Sometimes a very specific number of measurement points is required. With the *Bode 100* you can set any number of measurement points in the range 2...16501. To set the number of measurement points, click in the **Number of Points** box, and then enter the number of points you wish to use for your measurement.

Figure 10-18:
Entering the number of measurement points

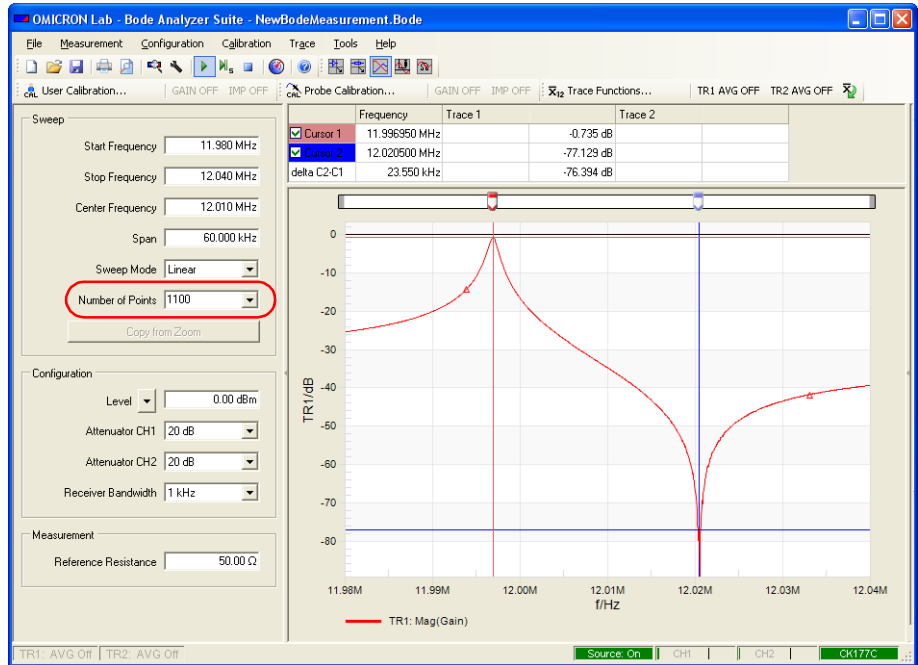

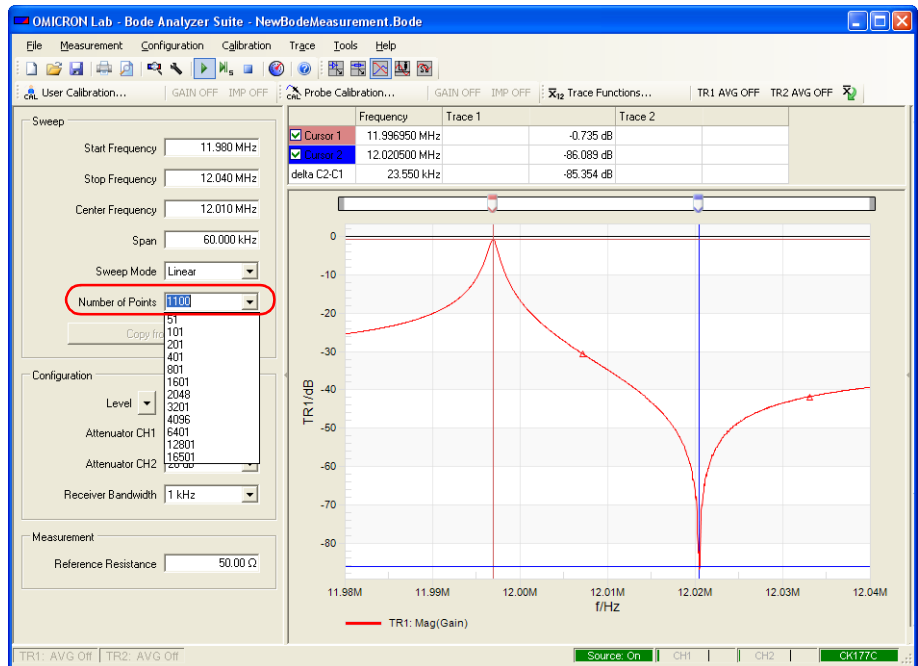

To get back a predefined number of measurement points, select the corresponding entry in the **Number of Points** list.

Figure 10-19:
Selecting a predefined
number of
measurement points



10.3 Unwrapped Phase

The **Unwrapped Phase** function is available in all frequency sweep modes (, , and ). Usually the phase is displayed between $\pm 180^\circ$ (± 3.14159 rad). By using the **Unwrapped Phase** function, you can display the phase continuously. In some applications such as calculation of the phase delay times (for example, for filters) an unwrapped, continuous display of the phase is very useful.

To activate the **Unwrapped Phase** function:

1. In the trace settings area of the *Bode Analyzer Suite* window, select the **Phase** format.

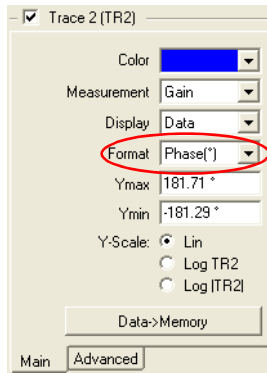

2. Click the **Advanced** tab, and then select the **Unwrapped Phase** check box.

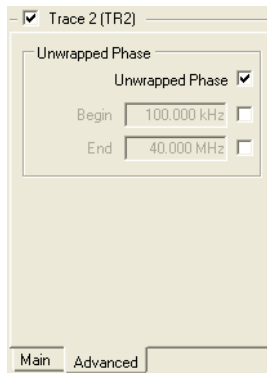

- Optionally, you can activate the **Unwrapped Phase** function within a specific frequency range. To do so, select the check boxes next to **Begin** and **End**, and then enter the begin and end frequencies between which a continuous phase is displayed.

Hint: Activating the **Unwrapped Phase** function within a frequency range is especially useful when the phase is instable or noisy at the start frequency of the sweep.

- To display the wrapped phase again, clear the **Unwrapped Phase** check box.

The following figures show a measurement with the wrapped and unwrapped phase.

Figure 10-20:
Example of the wrapped
phase

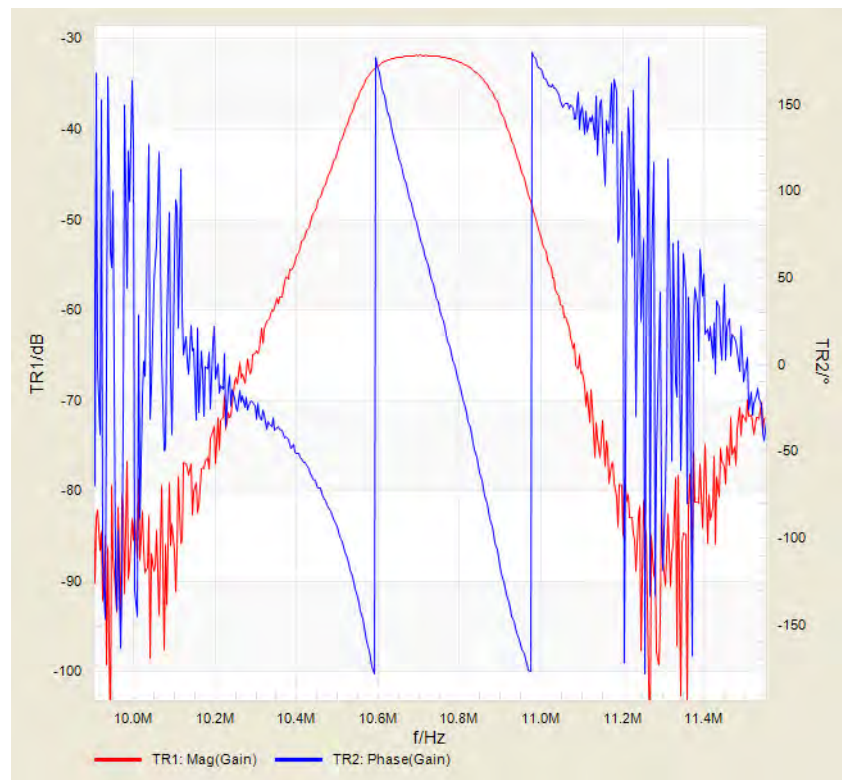
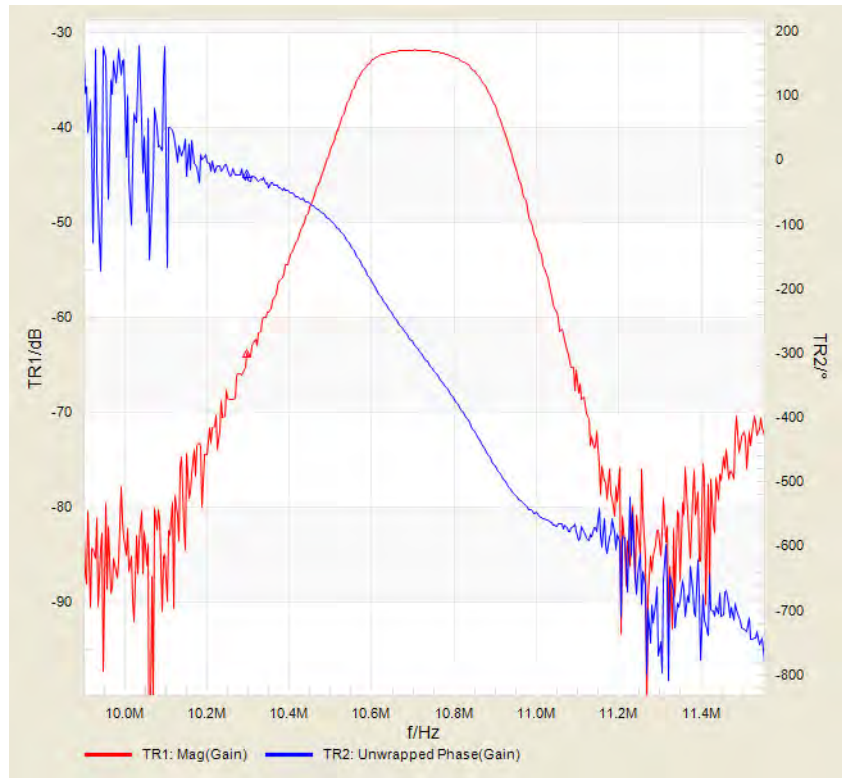

Figure 10-21:
Example of the
unwrapped phase



10.4 Using the Trace Functions

The *Bode Analyzer Suite* provides the following trace functions for advanced displaying of the measurement results in the **Frequency Sweep** mode:

- **Average**
- **Min Hold**
- **Max Hold**

You can control the trace functions in the trace functions area of the tool bar.

Figure 10-22:
Trace functions area of
the toolbar

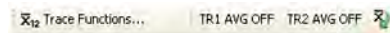

To activate the trace functions:



1. Click the **Trace Functions** button  to open the **Trace Functions – Settings** dialog box.

Figure 10-23:
**Trace Functions -
Settings** dialog box

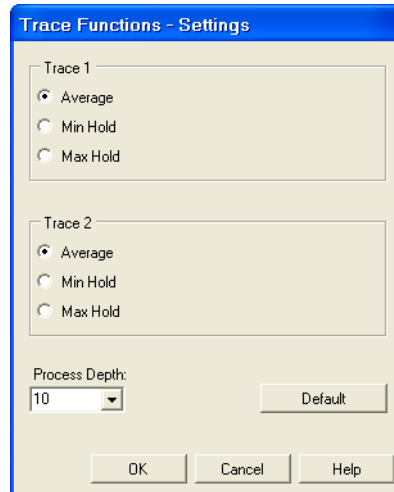

2. In the **Trace Functions – Settings** dialog box, select the trace function you want to use.
3. Select the process depth to define the number of sweeps used for the calculation of the selected trace function. The accuracy of the trace functions increases with the process depth value.
4. Click **OK**.

You can reset all trace functions settings to the default values by clicking the **Default** button.

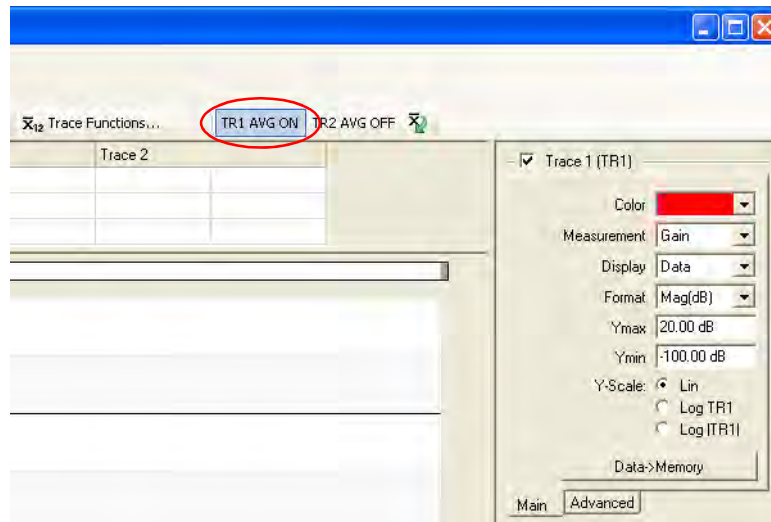

Hint: You can switch the trace functions on/off by clicking the **TR1 AVG OFF** button  for the corresponding trace. The first clicking of the **TR1 AVG OFF** button  starts the averaging. After that, clicking this button toggles between the averaged curve and the current (not averaged) sweep.

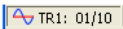
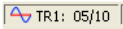
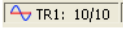

The averaging indicator in the status bar shows how many sweeps are currently used for the averaging.

Table 10-1:
Averaging indicator

Averaging Indicator	Description
	1 out of 10 sweeps is so far used for averaging.
	5 out of 10 sweeps are so far used for averaging.
	10 out of 10 sweeps are used for averaging.

By clicking the **Reset Trace Functions** button , you can set the number of sweeps used to calculate the **Average**, **Min Hold**, and **Max Hold** trace functions to zero – this restarts the trace function process. The **Reset Trace Functions** button  resets the number of used sweeps for both traces.

The trace function indicator in the status bar can show four different statuses:

Table 10-2:
Trace function indicator

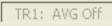
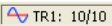
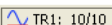
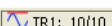
Trace Function Indicator	Description
	Trace function is switched off.
	Average trace function is used.
	Min Hold trace function is used.
	Max Hold trace function is used.

10.4.1 Average

By using the **Average** trace function of the *Bode 100*, you can reduce noise and remove stochastic events. Usually narrow receiver bandwidths are required to reduce the noise in a measurement, leading to long sweep times. Alternatively, you can use a wide receiver bandwidth and reduce the noise by averaging the measurement results over several sweeps. The noise reduction increases with the number of sweeps over which the measurement results are averaged.

The **Average** trace function displays a curve averaged over a defined number of sweeps. The measurement results are averaged in the complex plane. Each data point is a vector described by its real and imaginary part. The averaged curve is calculated at each data point as the vector sum of the measurement results obtained during the sweeps divided by the number of the sweeps:

$$\underline{G}_{Avg} = \frac{\sum_{i=1}^n \underline{G}_i}{n} \quad (\text{Eq. 10-1})$$

where the process depth n can be set between 1 and 99 or to the infinite value (see 10.4.4 "Setting the Process Depth to Infinity" on page 155).

Example: $n = 10$

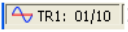
First sweep : The displayed curve after the first sweep is the current measurement.

$$\underline{G}_{Avg} = \underline{G}_1 \tag{Eq. 10-2}$$

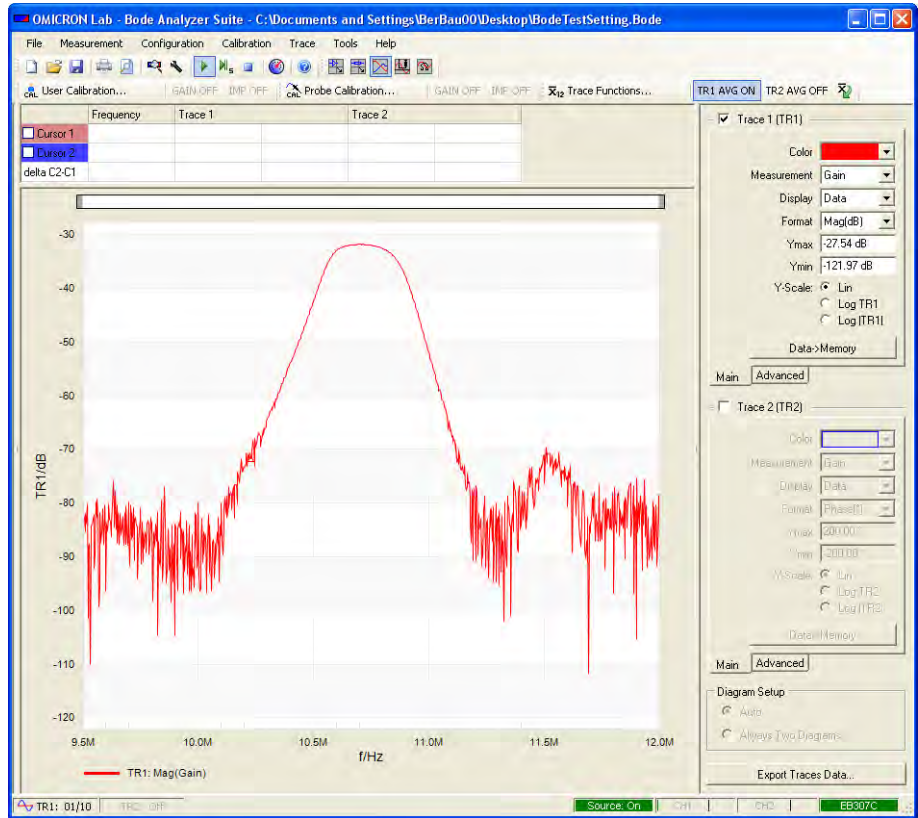

Fifth sweep TR1: 05/10 : The displayed curve is a curve averaged over the first five sweeps.

$$G_{Avg} = \frac{\sum_{i=1}^5 G_i}{5} \quad (\text{Eq. 10-3})$$

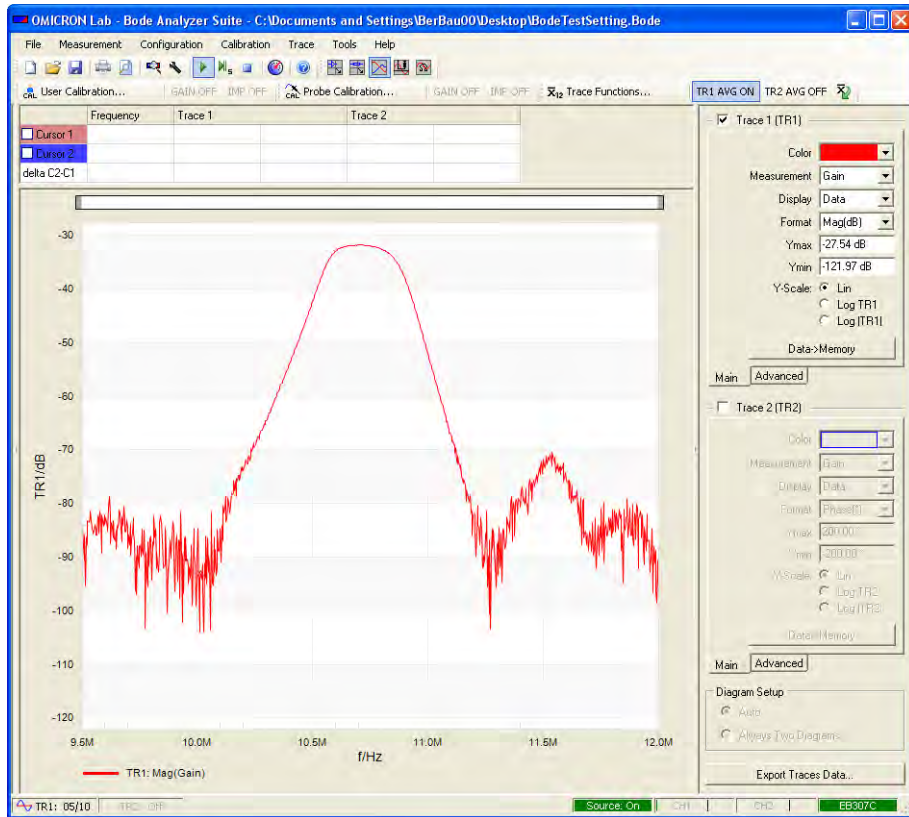

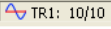
Tenth sweep and up : The displayed curve is a curve averaged over the last ten sweeps.

$$G_{Avg} = \frac{\sum_{i=1}^{10} G_i}{10} \quad (\text{Eq. 10-4})$$

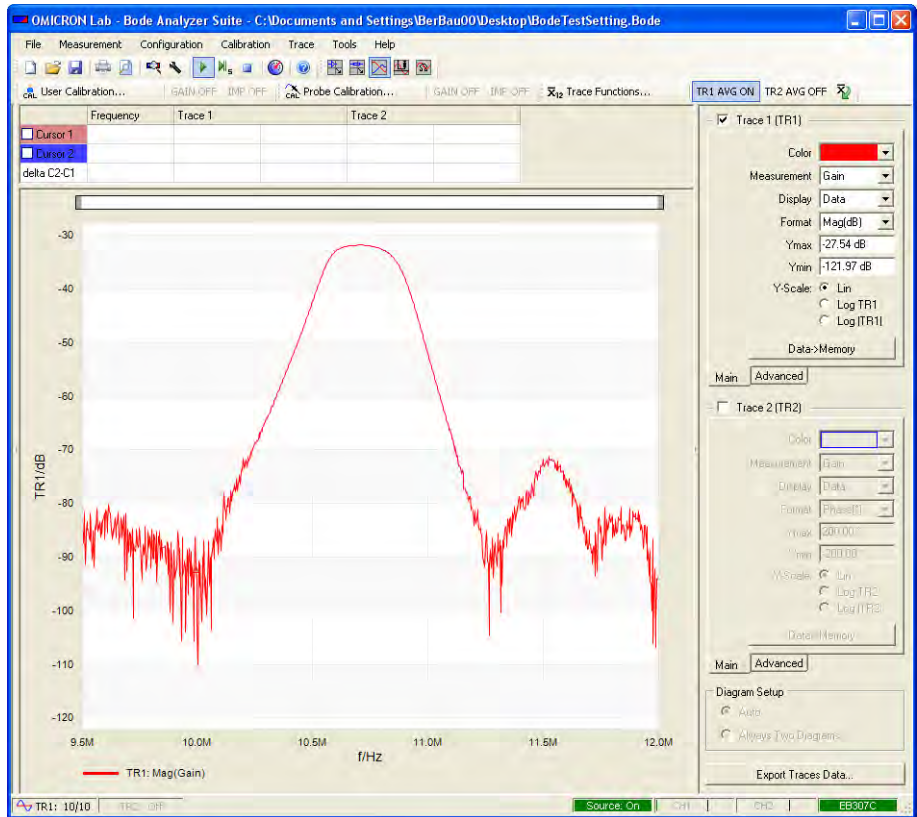

Hint: As soon as the defined process depth n (in this example 10) is reached, the last n sweeps are used for the calculation of the averaged curve.

10.4.2 Min Hold

If the **Min Hold** trace function is activated, the *Bode Analyzer Suite* displays the minimum of the selected output format. For example, if the **Imaginary** output format is selected for the **Gain** measurement, the minimum imaginary part of the defined number of sweeps is displayed.

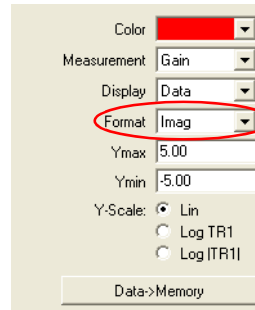

$$\text{Imag}(G_{min}) = \min_{i=1\dots n}(\text{Imag}(G_i)) \quad (\text{Eq. 10-5})$$

Hint: The **Min Hold** and **Max Hold** trace functions refer always to the selected output format.

10.4.3 Max Hold

If the **Max Hold** trace function is activated, the *Bode Analyzer Suite* displays the maximum of the selected output format. For example, if the **Imaginary** output format is selected for the **Gain** measurement, the maximum imaginary part of the defined number of sweeps is displayed.

$$\text{Imag}(G_{max}) = \max_{i=1\dots n}(\text{Imag}(G_i)) \quad (\text{Eq. 10-6})$$

The following figure shows the maximum and the minimum of the same measurement.

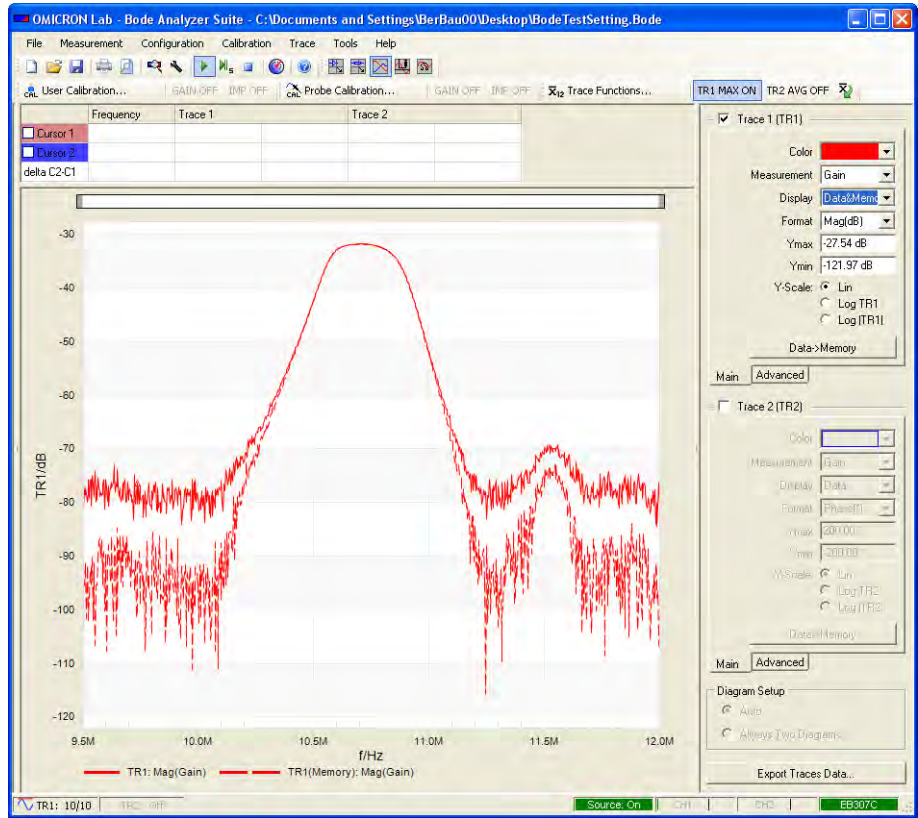

10.4.4 Setting the Process Depth to Infinity

To set the process depth to infinity, select **Infinity** in the **Trace Functions – Settings** dialog box.

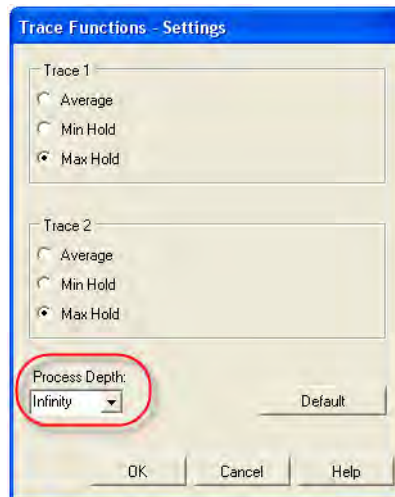
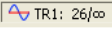

Figure 10-24:
Setting the process
depth to infinity



If you set the process depth to infinity, special incremental algorithms are used for calculating the **Average**, **Min Hold** and **Max Hold** trace functions. The advantage of these algorithms is that not all sweeps have to be stored for calculation. The following table shows how the algorithms work for different trace functions.

Trace Function	Description
Average	The incremental averaging works up to over two billion sweeps.
Min Hold/Max Hold	The Min Hold and Max Hold trace functions always show the minimum or maximum of all so far measured sweeps without limitation. The Min Hold and Max Hold trace functions work for the measurement format selected at the time the respective trace function was activated. If the measurement format is changed the trace function is reset and starts again with a new first sweep.

The following table shows how the process depth set to infinity is indicated.

Averaging Indicator	Description
	If the number of sweeps is less than 100, the current number of sweeps is displayed.
	If the number of sweeps is greater than 99, the infinity symbol is displayed.

10.5 Y-Axis Scaling



In all frequency sweep modes (, , and ), you can select the linear or the logarithmic scaling of the Y-axis. You can select the scaling of the Y-axis separately for each trace in the **Trace** menu.

Figure 10-25:
Setting the Y-axis
scaling



The default setting for the Y-axis scale is linear (Lin). If measurement curves contain very low and very high values, it is difficult to get a good impression about the curves characteristic for the low values. As an example of such a curve, the following chart shows the imaginary part of an inductance dominated by a resonance around 360 kHz.

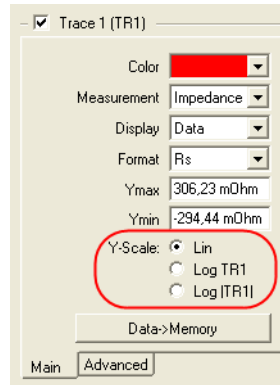
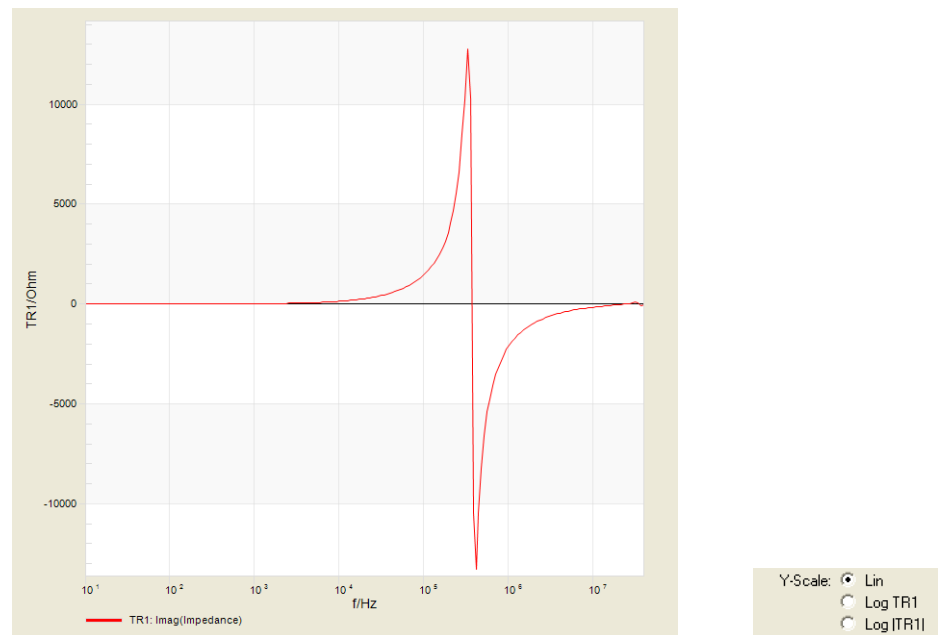

By switching to the logarithmic scaling (Log TR1), the characteristic provides a much better view on the inductor's behavior below the resonance frequency.

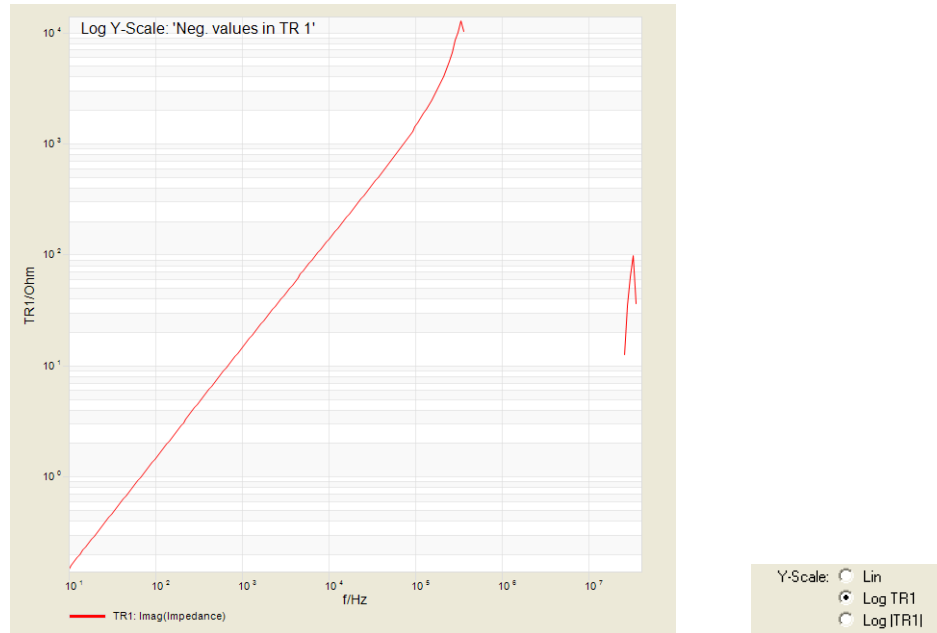

Since negative values cannot be displayed in a logarithmic scale, the curve will show gaps wherever negative measurement values are present. The presence of negative values is indicated by a warning message in the upper left corner of the frequency curve.

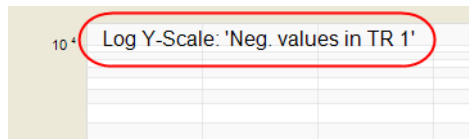

To display the measurement curve without gaps in the logarithmic scale, you can display the absolute values of the measurement (Log |TR1|).

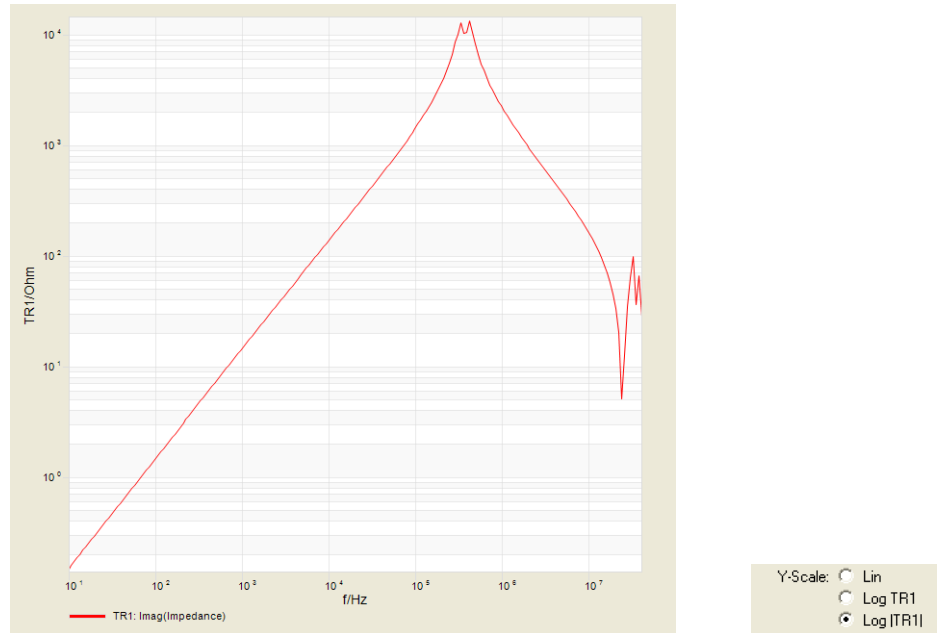

Hint: If the imaginary part of a DUT is displayed with the Log |TR1| scaling, a rising flank of the curve indicates an inductive behavior of the DUT while a falling flank indicates a capacitive behavior.

10.6 RLC-Q Sweep

The **RLC-Q Sweep** function is available for all frequency sweep modes (). By using the **RLC-Q sweep** function, you can display frequency swept curves for the serial and parallel equivalent circuits of the DUT. For the definitions of the equivalent components used in this section, see 4.1.2 "Equivalent Circuits" on page 37 and 4.1.3 "Quality Factor" on page 39.

For the **Impedance** measurement, the following quantities can be displayed:

- Series resistance R_s in Ohms
- Series inductance L_s in Henry
- Series capacitance C_s in Farad
- Q factor

Figure 10-26:
Setting the **Impedance**
measurement

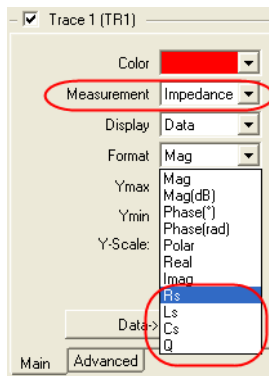

The following frequency characteristic shows the series inductance L_s of an inductor under test.

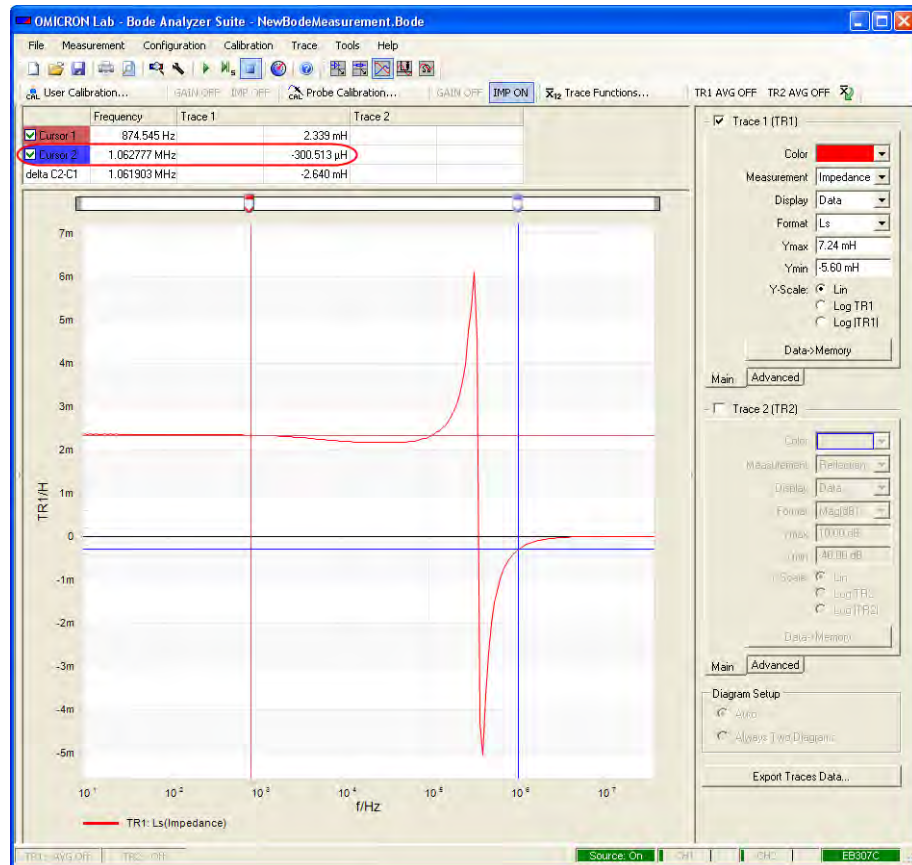

Hint: Negative readings in Henry (see cursor 2) indicate that the inductor under test shows capacitive behavior at the respective frequency.

For the **Admittance** measurement, the following quantities can be displayed:

- Parallel resistance R_p in Ohms
- Parallel inductance L_p in Henry
- Parallel capacitance C_p in Farad
- Q factor

Figure 10-27:
Setting the **Admittance**
measurement

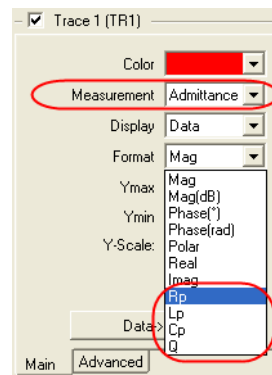

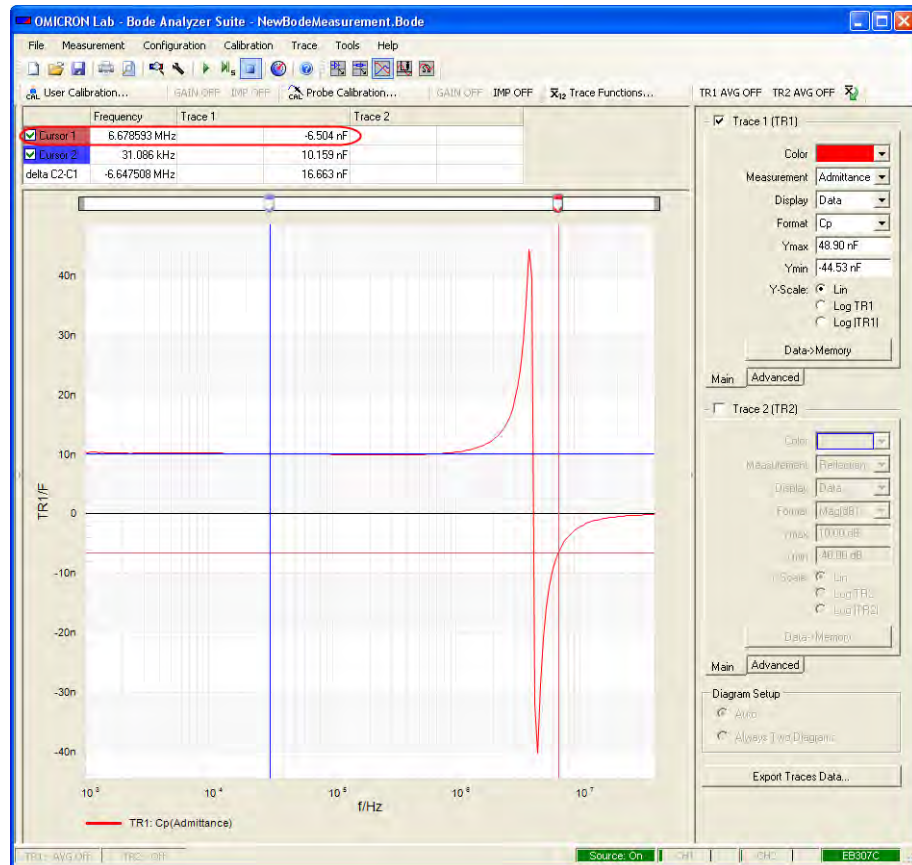

The following frequency characteristic shows the parallel capacitance C_p of a 10 nF foil capacitor.



Hint: Negative readings in Farad (see cursor 1) indicate that the capacitor under test shows inductive behavior at the respective frequency.

10.7 Level Shaping

By using the **Shaped Level** function available in all frequency sweep modes (,  and ), you can vary the *Bode 100* output level within the frequency sweep range. Possible applications for this functionality include:

- Avoiding nonlinearities during Control Circle analysis (e.g. of DC/DC converters)
- Reduction of noise or avoiding overloads for circuits showing a high dynamic variation of gain within the frequency sweep range

To activate the **Shaped Level** function:

1. In the **Configuration** area, click the **Level** arrow, and then click **Shaped Level**.

Figure 10-28:
Select the
Shaped Level function

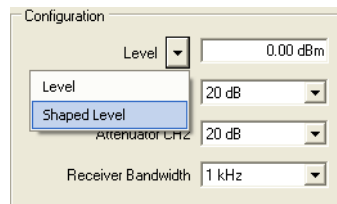

2. Click the **Shaped Level** button.

Figure 10-29:
Open the
Shaped Level window

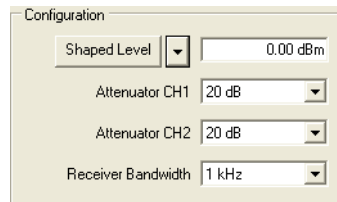

In the **Shaped Level** window, enter the frequencies and the delta output levels in dB relative to the reference level. In the **Output Level** column, the calculated output levels are displayed.

Figure 10-30:
Enter frequencies and
delta levels

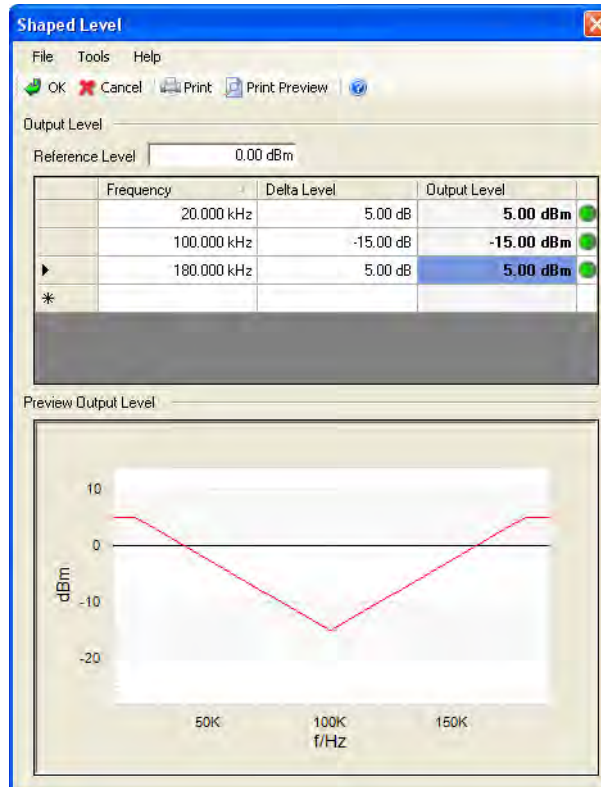

The green indicators next to the **Output Level** column signal that the output level is within the *Bode 100* output level range (-27 dBm...13 dBm). If an entered delta level results in an output level outside the *Bode 100* range, the output level is limited accordingly. The output level limiting is signaled by a red indicator (see the following figure).

You can shift the output level frequency characteristic up or down by changing the reference level in the **Reference Level** box.

Figure 10-31:
Change reference level

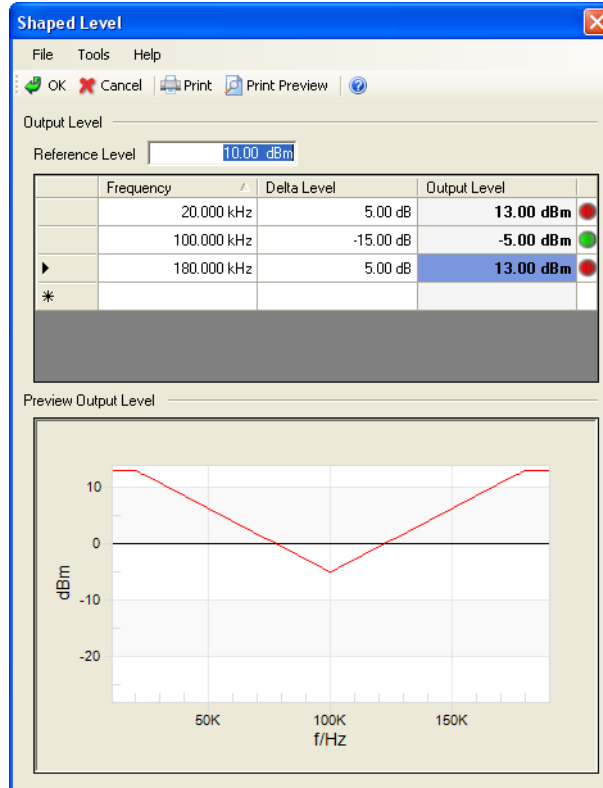

Hint: Based on the entered delta level the calculated output levels at 20 kHz and 180 kHz are outside the level range of the *Bode 100*. Therefore the values are limited to the maximum possible output level and the red indicators are activated.

You can shape very steep slopes by entering two delta levels at the same frequency. To select either the rising or falling edge, adjust the sequence of the delta levels:

1. Click in the respective frequency cell.
2. Right-click in the selected frequency cell, and then click **Set as First** or **Set as Second**.

Figure 10-32:
Original characteristic

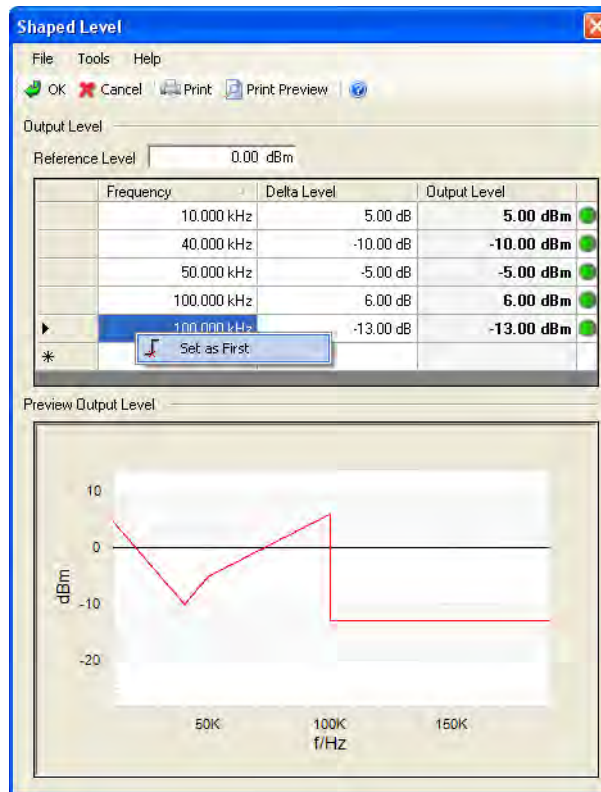

The figure shows the output level frequency characteristic before clicking **Set as First**.

Figure 10-33:
Characteristic with
changed slope

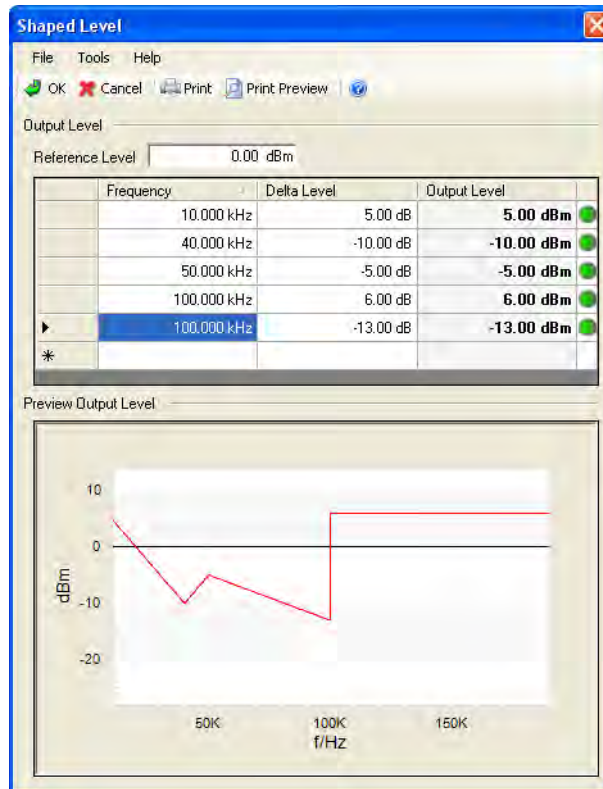

The figure shows the output level frequency characteristic after clicking **Set as First**.

10.8 Source Control

The *Bode Analyzer Suite* provides control of the *Bode 100* output source. With this function, you can switch the output source on and off. The source control is useful if, for example, some sensitive measurement objects should not be permanently exposed to the output signal of the *Bode 100*.

To access the source control:

1. Click **Device Configuration** on the **Configuration** menu or the **Device Configuration** toolbar button  to open the **Configuration** window.

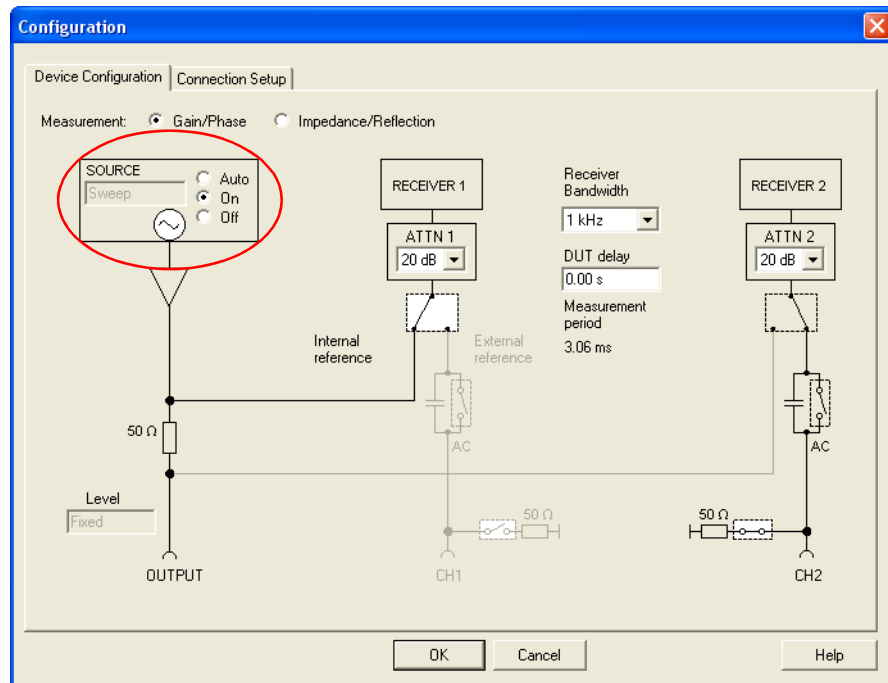

2. In the **Configuration** window, select one the following options:

Table 10-3:
Source control options

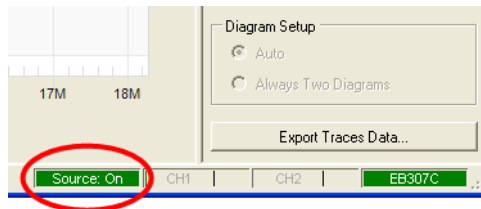

Source Control Option	Description
On (default)	The output source is always on.
Off	The output source is off.
Auto	The output source is switched on only during a measurement (▶ or ). The output source is switched off immediately after a measurement is stopped (■).

The source status is indicated in the status bar of the *Bode Analyzer Suite* window.

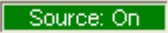

The following table shows the source status as indicated in the status bar of the *Bode Analyzer Suite* window.

Table 10-4:
Source control indicator

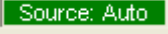
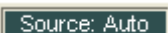
Source Control Indicator	Description
	The output source is on.
	The output source is off.
	The source output is on, a measurement is currently performed.
	The source output is off but will be immediately switched on when a measurement is started.

Note: If the output source is switched off no measurements can be performed.

10.9 Using Probes

With the *Bode 100* you can use measurement probes for channel 1 input and channel 2 input.

Figure 10-34:
Using a probe



Using the probes is recommended in the following applications:

- Measurements at points within the DUT circuitry not accessible with BNC cables
- Measurements of devices under test which are sensitive to capacitive or resistive influences (e.g. resonant circuits)

When using a probe, consider the following instructions:

1. Always set the correct probe ratio in the **Connection Setup** tab of the **Configuration** window.
You can choose between 1:1, 10:1 or 100:1.

Figure 10-35:
Setting the probe ratio

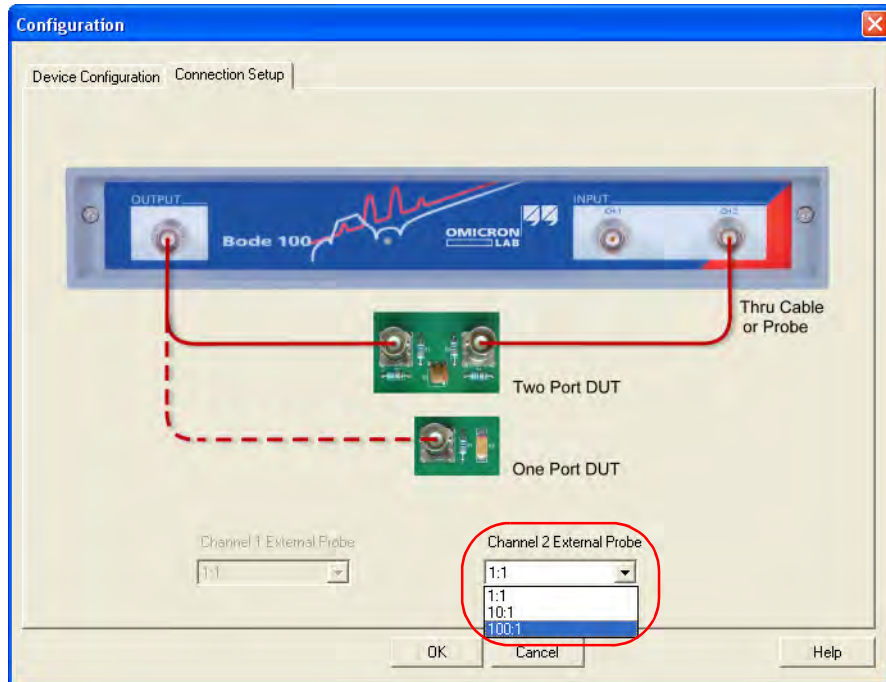

- For correct probe operation switch the input impedance of the channel connected to the probe to high impedance ($1\text{ M}\Omega$).

Figure 10-36:
Setting high input
impedance of channel 2

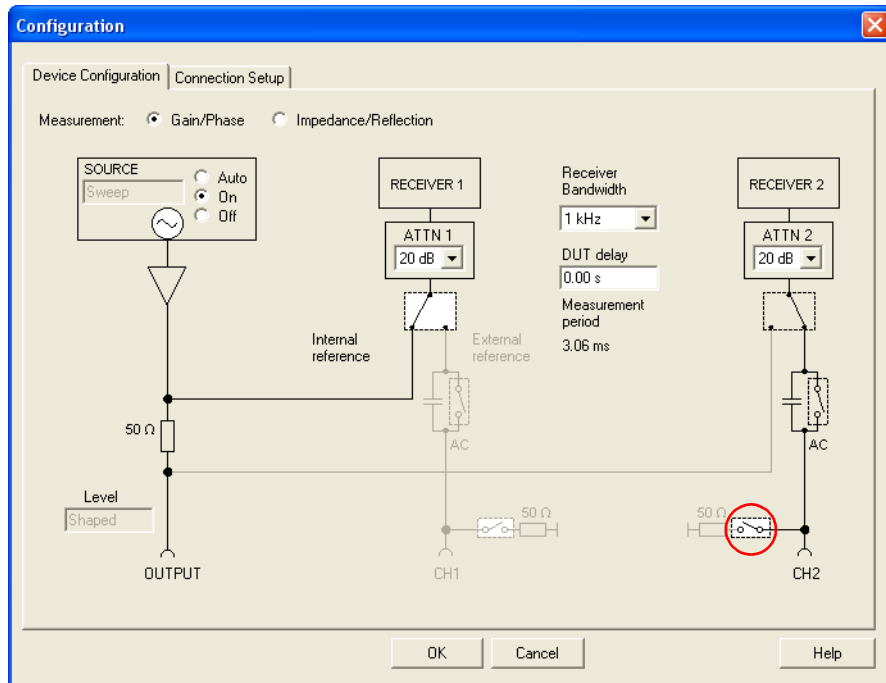

- Ensure that your DUT is terminated correctly.

Hint: When using a probe with a DUT which requires a $50\ \Omega$ termination, you can simply connect the BNC $50\ \Omega$ load delivered with your *Bode 100* to the output of the DUT.

- To obtain accurate measurement results, calibrate the *Bode 100* as follows:
- Connect the ground of the probe with the ground of the DUT and touch the DUT's input with the probe tip.
- Now, perform the calibration in the **Gain/Phase** mode as described in 3.3 "Example: Gain/Phase Measurement" on page 26.

Figure 10-37:
Touching the DUT's
input with the probe's tip

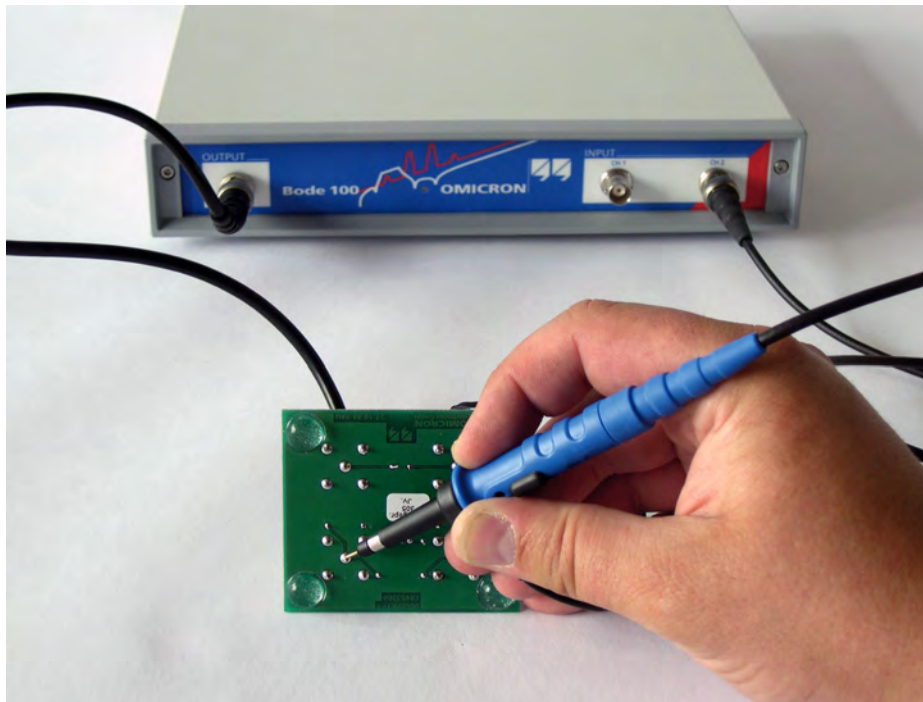

Hint: Ensure that the probe's tip is in contact with the DUT's input all the time until the calibration is finished.

7. After having calibrated the probe, start your measurement at any point of the DUT using the probe.

Congratulation! You learned how to use the advanced functions of the *Bode 100*.

How to:

- Use the advanced display functions like **Zoom** and **Copy to Clipboard**
- Use the advanced sweep options
- Use the level shaping functionality
- Use probes



The first time I used my measurement **probe** to **zoom** into an electrical circuit will always remain in my **memory**.

11 Automation Interface

So far you have worked with the *Bode 100* by using the graphical user interface (GUI) of the *Bode Analyzer Suite*. Beside this very comfortable user interface for laboratory use, the *Bode 100* provides also an all-purpose application programming interface (API) for interfacing with the *Bode 100*.

The *Bode Analyzer Automation Interface* supports OLE automation and allows quick access of the *Bode 100* using OLE compatible controllers such as Excel[®] or programming languages like Visual C++[®]. This allows simple integration of the *Bode 100* into automated measurement setups. Additionally, by using the *Bode Analyzer Automation Interface* you can directly control the *Bode 100* with programs such as LabVIEW and MATLAB.

The *Bode Analyzer Automation Interface* is automatically installed during the *Bode Analyzer Suite* installation and is available for use as soon as a *Bode 100* unit is connected to your computer. (You do not need to start the *Bode Analyzer Suite* to access the *Bode Analyzer Automation Interface*).

Figure 11-1: "Object hierarchy overview" on page 176 shows an overview of the command structure for the *Bode Analyzer Automation Interface*.

Note: An overview on the measurement functions available through the *Bode Analyzer Automation Interface* is provided in the Automation Interface Object Hierarchy and in the Automation Interface Reference. Both documents are located in the Automation subdirectory in the Bode Analyzer Suite directory. You can find detailed information how to access this directory on page 177.

Figure 11-1:
Object hierarchy
overview

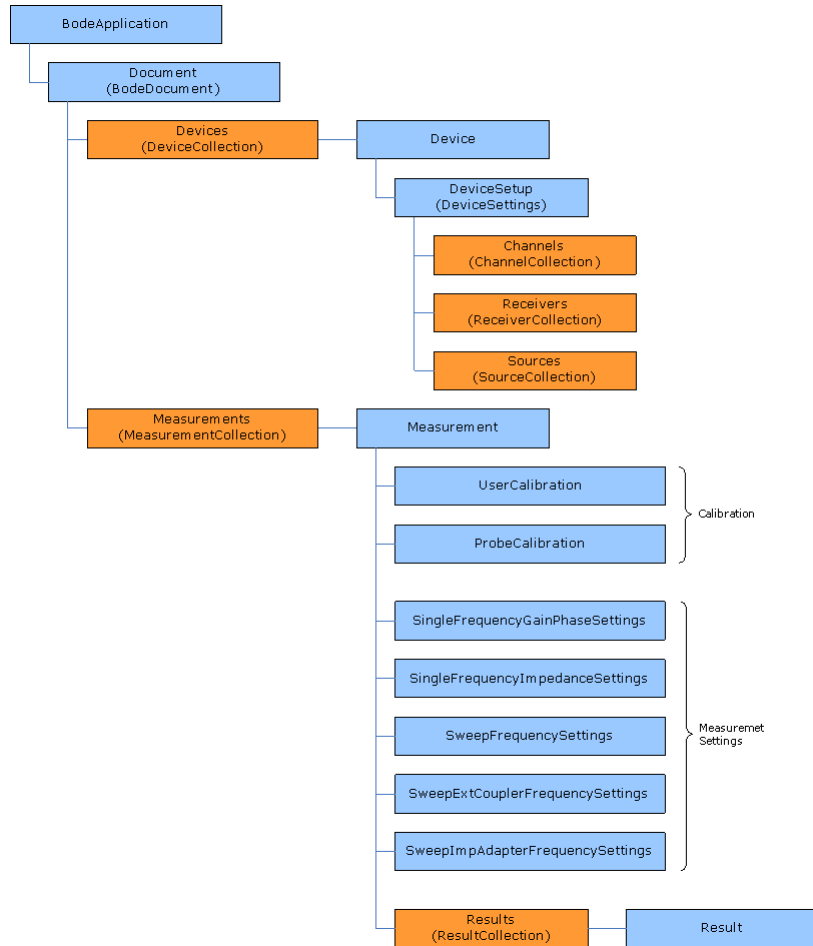

Hint: You can find a detailed overview of the *Bode Analyzer Automation Interface* object hierarchy in the Automation subdirectory of the Bode Analyzer Suite directory.

Figure 11-2: "Example of code segment for accessing the Bode Analyzer Automation Interface" on page 177 shows a typical code segment used to access functions of the *Bode Analyzer Automation Interface*. In this example, a *Bode 100* unit is searched for and, after a device has been found, measurement parameters are set.

Figure 11-2:
Example of code
segment for accessing
the *Bode Analyzer*
Automation Interface

```

Example
Visual Basic

Public Sub Main()
    Dim myBodeApp As New BodeAnalyzer.BodeApplication
    Dim myDocument As BodeAnalyzer.BodeDocument
    Dim mySelectedDevice As BodeAnalyzer.Device

    Set myDocument = myBodeApp.Document
    myDocument.Devices.ScanForDevices

    If myDocument.Devices.Count > 0 Then
        ' select the first device
        myDocument.Devices(1).SelectAndInit
        ' set default device settings
        myDocument.SelectedDevice.DeviceSetup.Bandwidth = Bandwidth_Hz100
        myDocument.SelectedDevice.DeviceSetup.DUTDelay = 0.000012 ' 12 ns
        myDocument.SelectedDevice.DeviceSetup.Channels(2).Termination500hm = True
        myDocument.SelectedDevice.DeviceSetup.Channels(2).Probe = ExternalProbe_Probe10to1
        myDocument.SelectedDevice.DeviceSetup.Receivers(1).Attenuator = Attenuator_dB0
        myDocument.SelectedDevice.DeviceSetup.Receivers(2).Attenuator = Attenuator_dB10
        myDocument.SelectedDevice.DeviceSetup.Sources.Level = 20 ' 20 dBm aren't possible, is changed to 13dBm (max. Level)
        myDocument.SelectedDevice.DeviceSetup.Sources(1).On = True
        myDocument.SelectedDevice.DeviceSetup.Sources(2).On = False

        Set mySelectedDevice = myDocument.SelectedDevice
        MsgBox "Device (Id: " & mySelectedDevice.DeviceId & ", Serial: " & mySelectedDevice.SerialNumber & ") selected and ready to use."
    Else
        ' No device connected
        MsgBox "No device connected."
    End If

    myBodeApp.Quit
End Sub

```

See Also
[Device Members](#)

For a complete description of the *Bode Analyzer Automation Interface*, see the *Bode Analyzer Automation Interface Reference*. To access it:

1. On the taskbar of your Windows® operating system, click the **Start** button, and then point to **Programs**.
2. Point to **Bode Analyzer Suite**, point to **Automation**, and then click **Automation Interface Reference**.

Congratulation! You learned:

- Basics of the *Bode Analyzer Automation Interface*
- About the object hierarchy of the used command structure
- Where to look for further information on the *Bode Analyzer Automation Interface*



Shout "OLE" to
celebrate your new
knowledge about the
Bode Analyzer
Automation Interface.

This page intentionally left blank

12 Troubleshooting

12.1 USB Cable and/or Power Supply to the *Bode 100* Is Missing

If the serial number field in the status bar displays **No Device** on red background then the *Bode Analyzer Suite* does not communicate with the *Bode 100*.



Solution: Connect the USB cable to the computer and the *Bode 100* and check the power supply. Then click the **Search and Reconnect Device** toolbar button  to connect the *Bode 100* with the computer.

12.2 Lost Communication

The loss of the power supply and other events can cause loss of communication between the *Bode 100* and the computer. In this case, the serial number field in the status bar displays **No Device** on red background.



Solution: Click the **Search and Reconnect Device** toolbar button  to connect the *Bode 100* with the computer.

12.3 Cannot Select Frequencies Lower Than 10 Hz

To activate the extended frequency range of 1 Hz...40 MHz, click **Options** on the **Tools** menu, click the **Measurement** tab, and then select the **Measurement Range 1 Hz - 40 MHz** option (see 9.2 "Setting the Measurement Range" on page 120).

Note: The activation of the measurement range of 1 Hz...40 MHz will increase calibration times including the internal calibration performed at the startup and each time you reconnect to the *Bode 100*.

This page intentionally left blank

13 Technical Data

13.1 Bode 100 Specifications

Table 13-1:
Bode 100 specifications

Characteristic	Rating
Frequency range (selectable by the <i>Bode Analyzer Suite</i>)	10 Hz...40 MHz or 1 Hz...40 MHz (extended frequency range)
OUTPUT connector	
Output impedance	50 Ω
Connector	BNC
Wave form	Sinusoidal signal
Output voltage	0.01...1 Vrms into 50 Ω load -27 dBm...13 dBm
INPUT CH 1, INPUT CH 2 connectors	
Input impedance	Low or high impedance selectable
Low impedance	Input impedance 50 Ω
High impedance	Input impedance 1 M Ω \pm 2% Input capacitance 40...55 pF
Connectors	BNC
Receiver bandwidth	1 Hz, 3 Hz, 10 Hz, 30 Hz, 100 Hz, 300 Hz, 1 kHz, 3 kHz
Input attenuator	0 dB, 10 dB, 20 dB, 30 dB, 40 dB
Input sensitivity	100 mV full scale for input attenuator 0 dB
Dynamic range	> 100 dB at 10 Hz receiver bandwidth
Gain error	< 0.1 dB (calibrated)
Phase error	< 0.5° (calibrated)
USB interface	
Connector	Type B

13.2 Power Requirements

Table 13-2:
Power requirements

Characteristic	Rating
AC power adapter	
Input voltage/frequency	100...240 V / 47...63 Hz
DC power supply	
Output voltage/output power	+10...24 V / 10 W
Inner connector	+10...24 V
Outer connector	Ground
Inner diameter	2.5 mm
Outer diameter	5.0 mm

13.3 Absolute Maximum Ratings

Table 13-3:
Absolute maximum
ratings

Characteristic	Absolute Maximum Rating
DC power input	
DC supply voltage	+28 V
DC supply reverse voltage (device does not work)	-28 V
INPUT CH 1, INPUT CH 2 connectors (high impedance)	
Maximum AC input signal	50 Vrms for 1 Hz...1 MHz 30 Vrms for 1 MHz...2 MHz 15 Vrms for 2 MHz...5 MHz 10 Vrms for 5 MHz...10 MHz 7 Vrms for 10 MHz...40 MHz
Maximum DC input signal	50 V
INPUT CH 1, INPUT CH 2 connectors (low impedance)	
Maximum input power	1 W (= 7 Vrms)
OUTPUT connector	
Maximum reverse power	0.5 W

13.4 System Requirements

Table 13-4:
Computer requirements

Characteristic	Requirement
Minimum configuration	Pentium 1 GHz 512 MB RAM Super VGA (1024×768) or higher-resolution video adapter and monitor CD-ROM drive USB 1.1 or USB 2.0 port
Recommended configuration	Pentium 2.5 GHz or higher 1 GB RAM or higher Super VGA (1024×768) or higher-resolution video adapter and monitor CD-ROM drive USB 2.0 port
Operating system	Windows® XP (32-bit and 64-bit), Windows® Vista (32-bit and 64-bit), Windows® 7 (32-bit and 64-bit)

13.5 Environmental Requirements

Table 13-5:
Environmental requirements

Characteristic	Condition	Rating
Temperature	Storage	−35...+60 °C / −31...+140 °F
	Operating	+5...+40 °C / +41...+104 °F
	For specifications	23 °C ± 5 °C / 73 °F ± 18 °F
Relative humidity	Storage	20...90 %, non-condensing
	Operating	20...80 %, non-condensing

13.6 Mechanical Data

Table 13-6:
Mechanical data

Characteristic	Rating
Dimensions (w × h × d)	26 × 5 × 26.5 cm / 10.25" × 2" × 10.5"
Weight	< 2 kg / 4.4 lbs

Hint: You can find more technical data on the OMICRON Lab Web site www.omicron-lab.com.

Contact Information / Technical Support

E-Mail: support@omicron-lab.com
Web: www.omicron-lab.com

or contact the following OMICRON electronics customer service centers:

Europe, Africa, Middle East

OMICRON electronics GmbH
Oberes Ried 1
A-6833 Klaus, Austria

Phone: +43 59495
Fax: +43 59495 9999

Asia, Pacific

OMICRON electronics Asia Ltd.
Unit 2812-19, 28/F, The Metropolis Tower
10 Metropolis Drive, Hung Hom
Kowloon, Hong Kong S.A.R.

Phone: +852 3767 5000
Fax: +852 3767 5400

North and South America

OMICRON electronics Corp. USA
3550 Willowbend Blvd
Houston, TX 77054, USA

Phone: +1 713 830-4660 or 1 800 OMICRON
Fax: +1 713 830 4661

Alternatively, visit our Web site www.omicron-lab.com for customer service centers in your area.

This page intentionally left blank

Index

A

address
 manufacturer 185
 admittance 36
 automation interface 175–177
 Average 149–152

B

basics
 Bode Analyzer Suite 117
 Gain/Phase mode 22
 Impedance/Reflection mode 36
 BNC
 cable 14
 connector 181
 load 14, 43
 short circuit 14
 straight adapter 14, 31, 62, 100, 107
 T adapter 14

C

calibration
 Gain/Phase 31–32, 92–96
 Impedance 62–64, 97–102, 106–109,
 110–116
 internal 89
 probe 32, 89–90, 91, 94, 99
 user 32, 90–91, 94, 99, 133
 CD-ROM 14, 17

configuration
 Frequency Sweep
 (External Coupler) mode 69–72
 Frequency Sweep
 (Impedance Adapter) mode 80–82
 Frequency Sweep mode 52–55
 Gain/Phase mode 27–30
 Impedance/Reflection mode 41–43
 connector
 DC power supply 182
 INPUT CH1 12
 INPUT CH2 12
 OUTPUT 12
 USB 17, 181
 cursor functions 58, 59

E

EN/IEC 61010-1 13
 EN/IEC 61326-1 13
 equivalent circuit 37–39
 external coupler 67, 69, 106

F

filter
 IF 14, 26–32, 39–44, 69–77, 97–103
 quartz 14, 52–66, 135–139
 frequency range
 changing 120, 179

G

group delay 22, 52, 60

H

hotline 185

I

IF filter 14, 26–32, 39–44, 69–77, 97–103
 impedance 36
 impedance adapters 15, 79–88
 installation 17

L

level shaping 164–174

M

manufacturer address 185
 Max Hold 153
 measurement range 120, 179
 Min Hold 153
 mode
 Full Speed 120
 High Speed 120

O

OMICRON Lab address 185

P

polar curve 75
 power supply 14, 17, 179, 182
 powering 17
 print function 118
 probe calibration 32, 89–90, 91, 94, 99

Q

quality factor 39
 quartz filter 14, 52–66, 135–139

R

receiver bandwidth 20, 54, 76, 105, 181
 reference
 conductance 36
 plane 36
 resistance 36, 44, 56, 60, 73
 reference connection
 external 25
 internal 24
 reflection coefficient 36, 39–44, 52–61, 98–103
 RLC-Q Sweep 160–163

S

shaped level 164–174
 Smith chart 9, 52, 65
 source control 169–170
 standard compliance 13
 support 185

T

- technical support 185
- trace functions
 - Average 149–152
 - Max Hold 153
 - Min Hold 153

U

- Unwrapped Phase 144–146
- USB
 - cable 14, 17, 179
 - connector 17, 181
 - interface 10, 13, 17
 - specification 13
- user calibration 32, 90–91, 94, 99, 133

V

- VSWR 36, 44, 56, 69, 73, 77

W

- window
 - Frequency Sweep (External Coupler) mode 67
 - Frequency Sweep (Impedance Adapter) mode 79
 - Frequency Sweep mode 47
 - Gain/Phase mode 19
 - Impedance/Reflection mode 35

